



This is a digital copy of a book that was preserved for generations on library shelves before it was carefully scanned by Google as part of a project to make the world's books discoverable online.

It has survived long enough for the copyright to expire and the book to enter the public domain. A public domain book is one that was never subject to copyright or whose legal copyright term has expired. Whether a book is in the public domain may vary country to country. Public domain books are our gateways to the past, representing a wealth of history, culture and knowledge that's often difficult to discover.

Marks, notations and other marginalia present in the original volume will appear in this file - a reminder of this book's long journey from the publisher to a library and finally to you.

Usage guidelines

Google is proud to partner with libraries to digitize public domain materials and make them widely accessible. Public domain books belong to the public and we are merely their custodians. Nevertheless, this work is expensive, so in order to keep providing this resource, we have taken steps to prevent abuse by commercial parties, including placing technical restrictions on automated querying.

We also ask that you:

- + *Make non-commercial use of the files* We designed Google Book Search for use by individuals, and we request that you use these files for personal, non-commercial purposes.
- + *Refrain from automated querying* Do not send automated queries of any sort to Google's system: If you are conducting research on machine translation, optical character recognition or other areas where access to a large amount of text is helpful, please contact us. We encourage the use of public domain materials for these purposes and may be able to help.
- + *Maintain attribution* The Google "watermark" you see on each file is essential for informing people about this project and helping them find additional materials through Google Book Search. Please do not remove it.
- + *Keep it legal* Whatever your use, remember that you are responsible for ensuring that what you are doing is legal. Do not assume that just because we believe a book is in the public domain for users in the United States, that the work is also in the public domain for users in other countries. Whether a book is still in copyright varies from country to country, and we can't offer guidance on whether any specific use of any specific book is allowed. Please do not assume that a book's appearance in Google Book Search means it can be used in any manner anywhere in the world. Copyright infringement liability can be quite severe.

About Google Book Search

Google's mission is to organize the world's information and to make it universally accessible and useful. Google Book Search helps readers discover the world's books while helping authors and publishers reach new audiences. You can search through the full text of this book on the web at <http://books.google.com/>

Tab
Sch 3.3
ma

JP

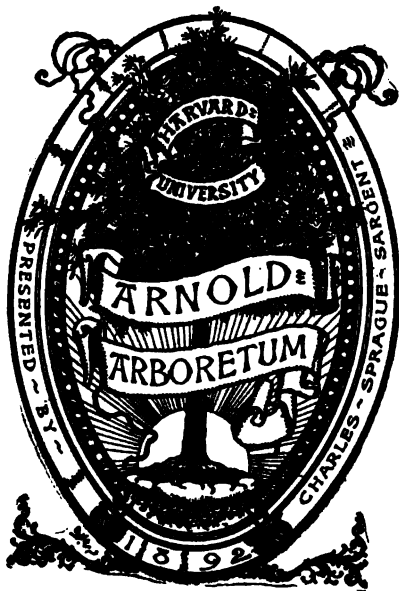

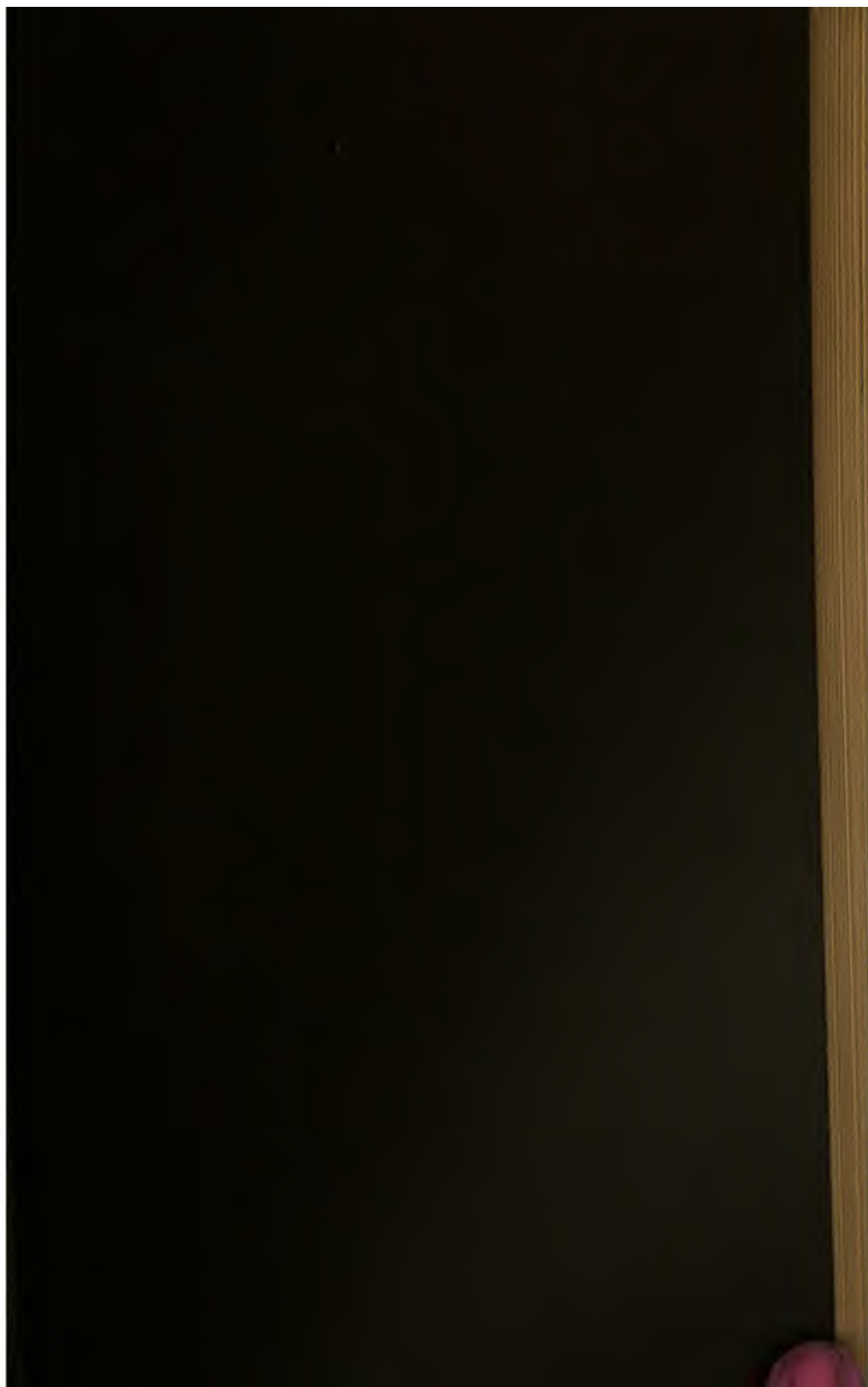

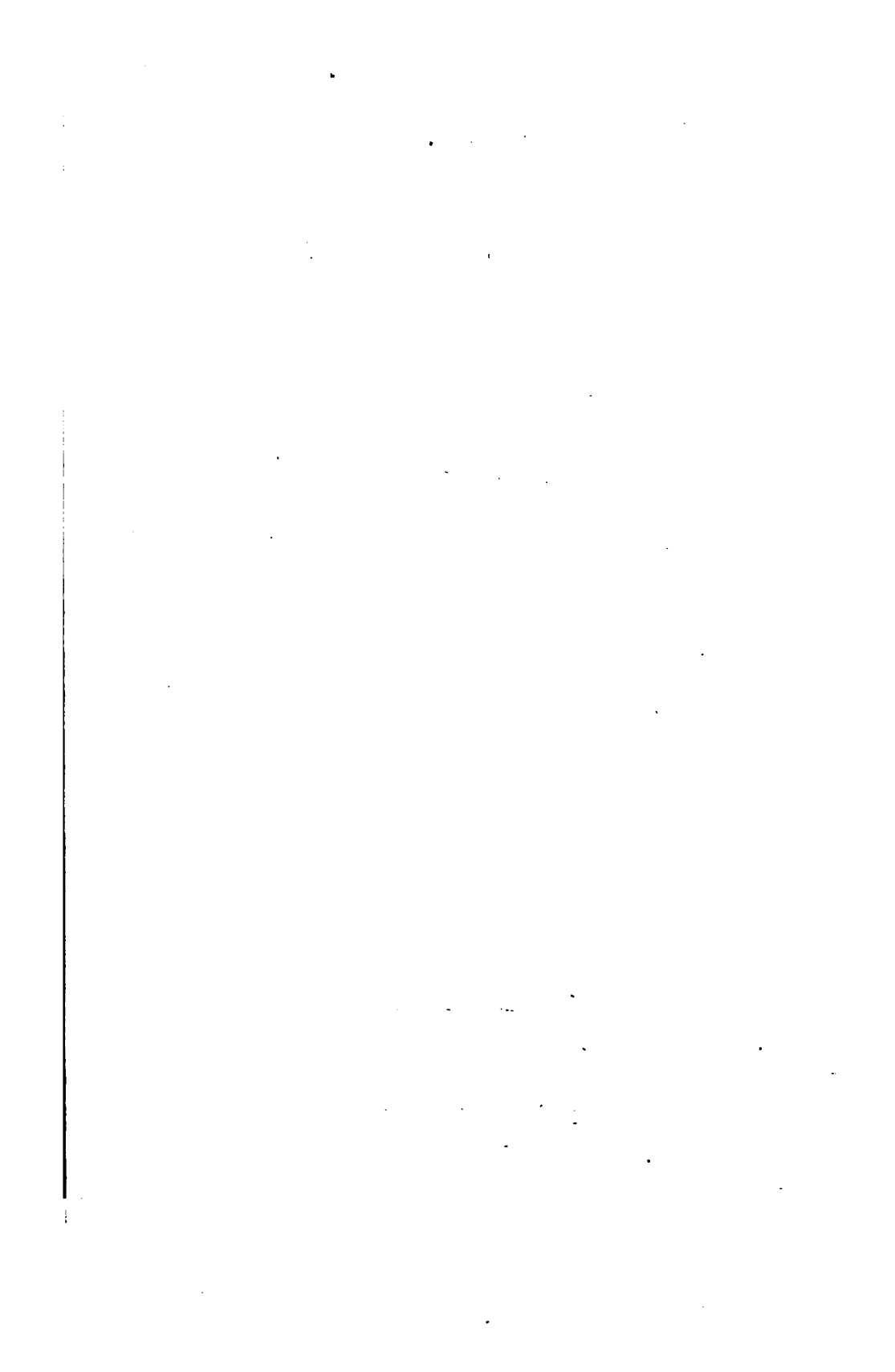

SCHLICH'S
MANUAL OF FORESTRY.
—
FOREST UTILIZATION.

THE MANUAL OF FORESTRY consists of the following volumes:—

- Volume I.—FOREST POLICY IN THE BRITISH EMPIRE.
- „ II.—SYLVICULTURE.
- „ III.—FOREST MANAGEMENT.
- „ IV.—FOREST PROTECTION.
- „ V.—FOREST UTILIZATION.

Volume I. was published in 1889, under the heading “The Utility of Forests and Principles of Sylviculture;” its title was changed as above in the third edition published in 1906; Volume II. was published in 1891, the third edition in 1904; Volume III. in 1895, the third edition in 1905; these three volumes have been written by me. Volume IV. was published in 1895, second edition in 1907, and this and the present Volume V. have been written by my colleague Mr. W. R. Fisher.

W. SCHLICH.

OXFORD.

July 1st, 1908.

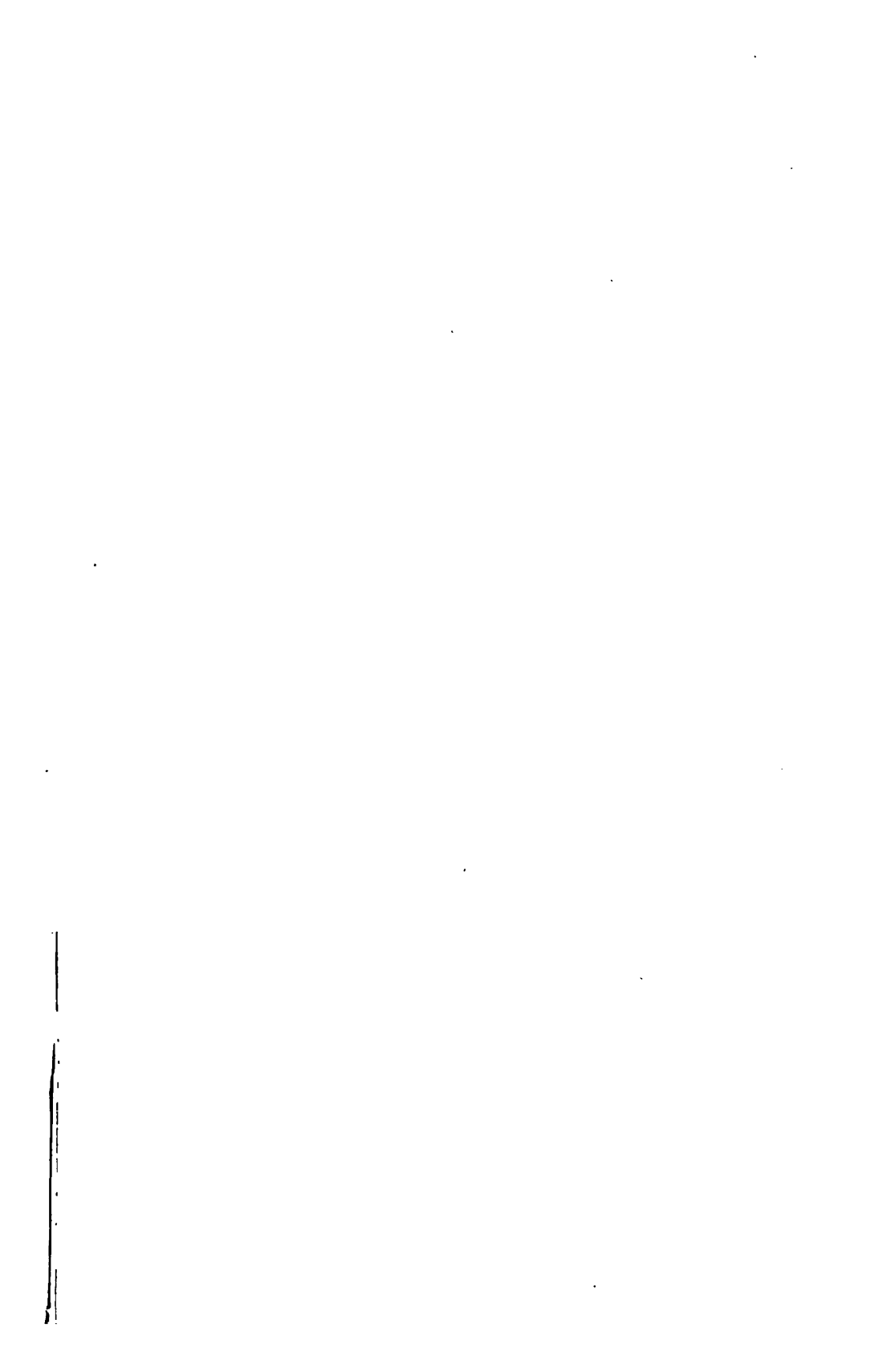



Gaynes
R. Gaynes, Prnt.

[Frontispiece.]

#

SCHLICH'S
=
MANUAL OF FORESTRY.

VOLUME V.

FOREST UTILIZATION,

BY

W. R. FISHER, M.A., CANTAB. ET OXON.,

ASSISTANT PROFESSOR OF FORESTRY, UNIVERSITY OF OXFORD; LATE CONSERVATOR OF FORESTS
TO THE GOVERNMENT OF INDIA.

WITH 402 ILLUSTRATIONS IN THE TEXT, 5 FULL PLATES,
AND FRONTISPIECE.

BEING

AN ENGLISH TRANSLATION OF

“DIE FORSTBENUTZUNG,” BY DR. KARL GAYER,

LATE PRIVY COUNCILLOR IN BAVARIA, AND PROFESSOR OF FORESTRY
AT THE UNIVERSITY OF MUNICH.

SECOND EDITION.

LONDON:

BRADBURY, AGNEW, & CO. LD., 10, BOUVERIE STREET.

1908.

Dec. 1908
189 5-5

BRADBURY, AGNEW, & CO. LT., PRINTERS.,
LONDON AND TONBRIDGE.

PREFACE TO FIRST EDITION.

THE present book, with Dr. Schlich's permission, forms Volume V. of the Manual of Forestry. It is an English translation of the volume on FORSTBENUTZUNG* by Dr. Karl Gayer, Professor of Forestry at the University of Munich, the first edition of which was published in 1868, and the eighth and last edition in 1894. Dr. Gayer's book is the recognised standard German work on the subject of Forest Utilization; although it may appear somewhat detailed for the present condition of British Forestry, yet it is fitting to complete the Manual of Forestry by giving a full account of the economic methods of working forests as they are practised in Continental Europe.

I have added considerably to the original work by notes and illustrations from my own and other experience in Britain, France, and India; the number of plates in the original work (297) has also been increased to 343 in the translation.

Monsieur L. Boppe, the Director of the French National Forest School at Nancy (where I received my first instruction in Forestry), has kindly allowed me the use of many of the plates in his TECHNOLOGIE FORESTIÈRE,† which have been acknowledged duly in the text, wherever they occur. Chapter VIII. of Part III., which deals with resin-tapping, is taken mainly from Mr. Boppe's book.

The last chapter of my book, dealing with the extraction of oil of turpentine and rosin, from crude resin, is taken chiefly

* "Die Forstbenutzung," von Dr. Karl Gayer, eighth edition, Berlin. Published by Paul Parey, 10, Hedemaunstrasse. 1894.

† A considerably enlarged edition of a work by H. Nanquette, Honorary Director of the Nancy Forest School, Paris, 1887, Berger-Levrault et Cie., 5, Rue des Beaux Arts.

from papers by Mr. N. Hearle and Mr. E. McA. Moir of the Indian Forest Department, that appeared in the *Indian Forester*.

The enormous consumption of timber, in North America and elsewhere, points to a period in the immediate future when the world-supply of timber will be greatly restricted; it is already the duty of statesmen in all civilized countries to adopt measures for rendering them, in a certain degree, independent in this respect. A careful method of utilizing the resources of their forests is of the highest importance for the vast dependencies of the British Empire, whether in India, Canada, Australasia or South Africa, as well as for the United States. It may therefore be asserted confidently that, the general principles of the economic working of forests, now almost for the first time* expounded in the English language, are applicable wherever that language is spoken.

I have to thank my colleagues, Dr. Schlich and Dr. Matthews, for their kindness in assisting me to revise the proofs, and for some valuable suggestions they have made. Professor Hearson has also helped me in dealing with superstructures (pp. 113—114), and Professor Heath, in the antiseptic treatment of timber (p. 659).

W. R. FISHER.

COOPERS HILL COLLEGE,

May 1st, 1896.

* The Utilization of Forests, by E. E. Fernandez, Dehra Dun, 1891, is applicable chiefly to India and less comprehensive than the present volume.

PREFACE TO SECOND EDITION.

THE first edition of this book (1,500 copies), which was published in 1896, has been sold, and it has become my duty to prepare a second edition. Schlich's *Manual of Forestry* is intended to give a clear picture of forestry, as practised in those countries where the industry has been brought to the greatest perfection, and that purpose has been followed in the instruction given by us to the forest students who go to India or the Colonies, or who remain in this country.

No writer on Forest Utilization fulfils this purpose, as do **Gayer** and his eminent co-author and successor, **Dr. Heinrich Mayr**. The latter has travelled through most of the forests in Europe, America, Japan and India, and has used the store of knowledge he has gained, in rearranging Gayer's book, which is brought up completely to date in this, its ninth edition. The author's preface to this edition, that follows, shows, to some extent, how greatly this old classic work has been improved. An important book, "*Traité d'exploitation commerciale des bois*," in two large volumes, written by **Alphonse Mathey**, published in 1906 and 1908, gives the French views of Forest Utilization, and contains much original matter dealing with French indigenous and colonial forest produce. As the French have never had separate instruction in Forest Protection, a subject dealt with in Volume IV. of this *Manual*, the diseases in trees due to fungi, are therein described in detail that is not required here. Mathey's second volume is a compendium of the usages of the French timber trade, and deals also with French minor produce in a comprehensive manner. This work, however, follows Gayer in general matters, and reproduces many of Gayer's plates.

R. S. Troup has written a treatise on "Indian Forest Utilization," that is based also on Gayer's book, and brings up to date Fernandez' "Notes on the Utilization of Forests," written from an Indian point of view. The American forestry department has published a number of pamphlets on various matters connected with Forest Utilization, but I know of no American general treatise on the subject, except a short book of 118 pages, by C. A. Schenk, 1904. I append a list of American books on the subject kindly sent me by Mr. G. Pinchot. In Britain, the only text-books available are on timber, by Laslett, Stone, and Boulger, and from these I have borrowed an occasional note.

Many friends have urged me to write an original book on Forest Utilization, but I could do so only by borrowing from Gayer on a very large scale, and in fact by following closely in the excellent lines he has laid down. Such a book could be only a compilation, and it seems to me to be not only more honest, but also more useful for students of forestry, to translate the only general work on the subject that exists, while making additions to it, from an English point of view, wherever they are needed. All these additions are made in parentheses and signed by the translator.

Although this edition contains much matter that is not in the first edition, Mayr has been able to compress Gayer's book, so that in the translation there are now 840 instead of 774 pages, while the number of plates in the text are 402 instead of 329, besides five full-page plates instead of three. Gayer's book contains 341 plates only.

LIST OF AMERICAN BOOKS ON FOREST UTILIZATION.

Prepared by RAPHAEL ZON. *October 11th, 1907.*

"Forest Utilization," C. A. Schenck, Biltmore, N. C., 1904. Pp. 118. \$5.

"Road Making and Maintenance," Chapter on "Wood Paving," by Thomas Aitkins, 1900. J. B. Lippincott, Co., Philadelphia. Pp. 323 to 347. \$6.

- "Treatise on Roads and Pavements," by Ira Osborn Baker. J. Wiley & Sons, New York, 1903. Pp. 655. \$5.
- "Pavements and Roads," by Edward G. Love. Engineering and Building Record, New York, 1890. \$5.
- "Roads and Pavements," by Fred P. Spaulding. J. Wiley & Sons, New York, 1906. Pp. 235. \$2.
- "Timber Physics, Materials of Construction," by J. B. Johnson. J. Wiley & Sons, New York, 1897. \$6.
- "Handbook of Timber Preservation," by Samuel M. Rowe. Pettebone, Sawtelle & Co., Chicago, 1904. \$5.
- "History of the Lumber Industry in America," by James Elliot Defebaugh, Vol. I. The American Lumberman, Chicago, 1906. \$5.
- "Proceedings of the American Forest Congress, Forestry and Irrigation," Washington, D. C., \$1.25.
- "Forest Mensuration," by H. S. Graves. J. Wiley & Sons, New York, 1906. Pp. 458. \$4.
- "Principal Species of Wood; Their Characteristics and Properties," by Charles Henry Snow. J. Wiley & Sons, New York. Chapman & Hall, London, 1903. Pp. 203. \$3.50.
- "Economic Uses of Wood," by W. R. Lazenby, Columbus, Ohio. Ohio State University, 1904. Pp. 14. Free.

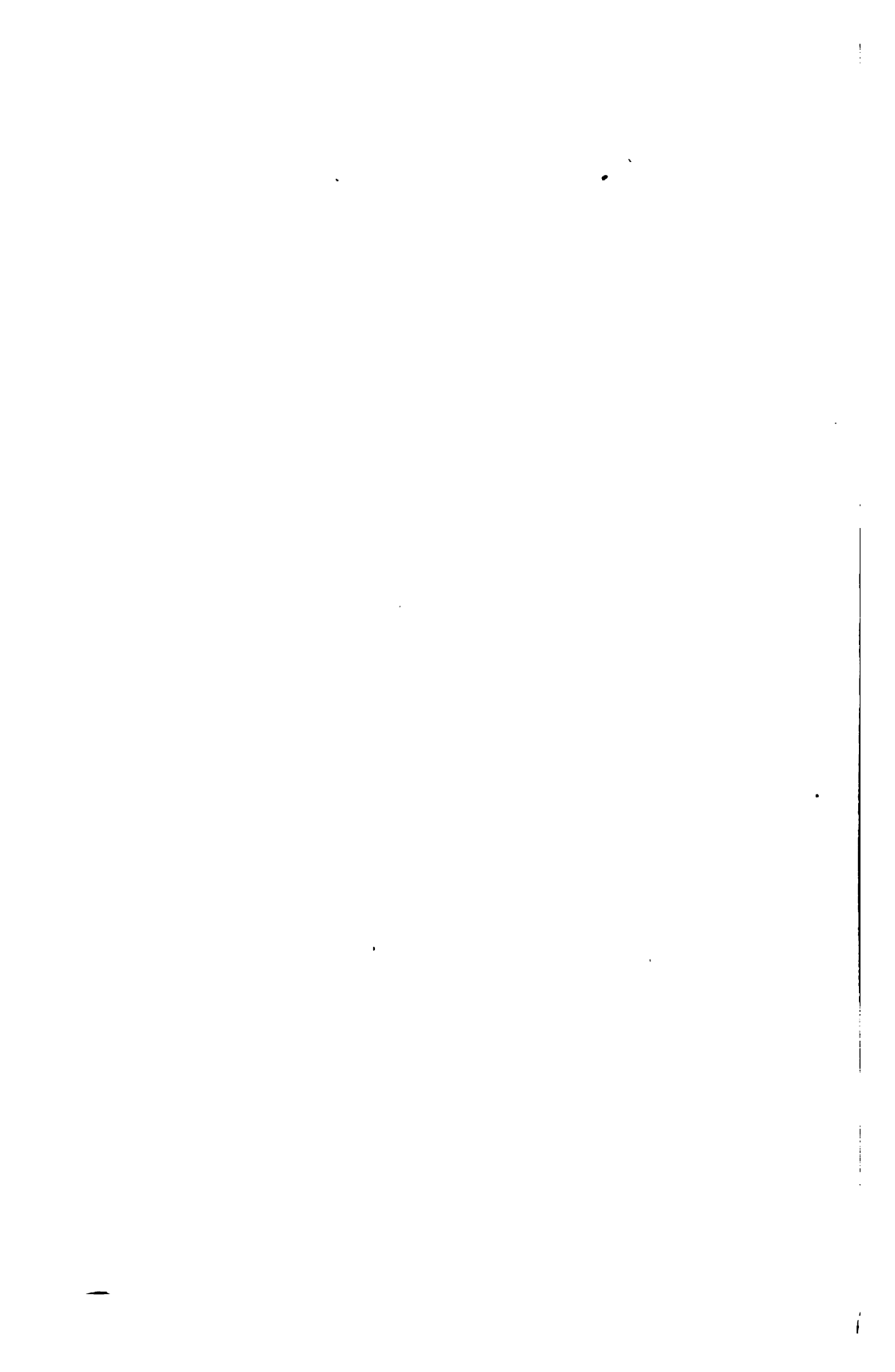

AUTHOR'S PREFACE TO THE NINTH EDITION.

IN order to preserve for my book on Forest Utilization the place it has gained in forest literature, and owing to my advanced age, I have shared the work of writing its ninth edition with my successor in the Chair of Forest Utilization, Dr. Heinrich Mayr.

We have determined to bring the book up to date, by utilizing all the available research of the nineteenth century, by making purely German matter most prominent, but also by taking into consideration matter from other countries, so that the book may be built on a broader foundation than before.

The table of contents will show that considerable changes have been made in the arrangement of material. Some changes have been made also in the technical treatment of the subject. Several chapters, or sections, have been rewritten, or expanded, chiefly from a scientific point of view, while other parts of the book have been curtailed.

Fifty new plates have been added, bringing the number of these up to 322.

Our acknowledgments are due to the publishers, who have done their duty excellently.

It is our hope that the book, in its new form, will meet with extensive support, and will prove useful to students and to practical foresters.

GAYER.

MUNICH,
January, 1903.

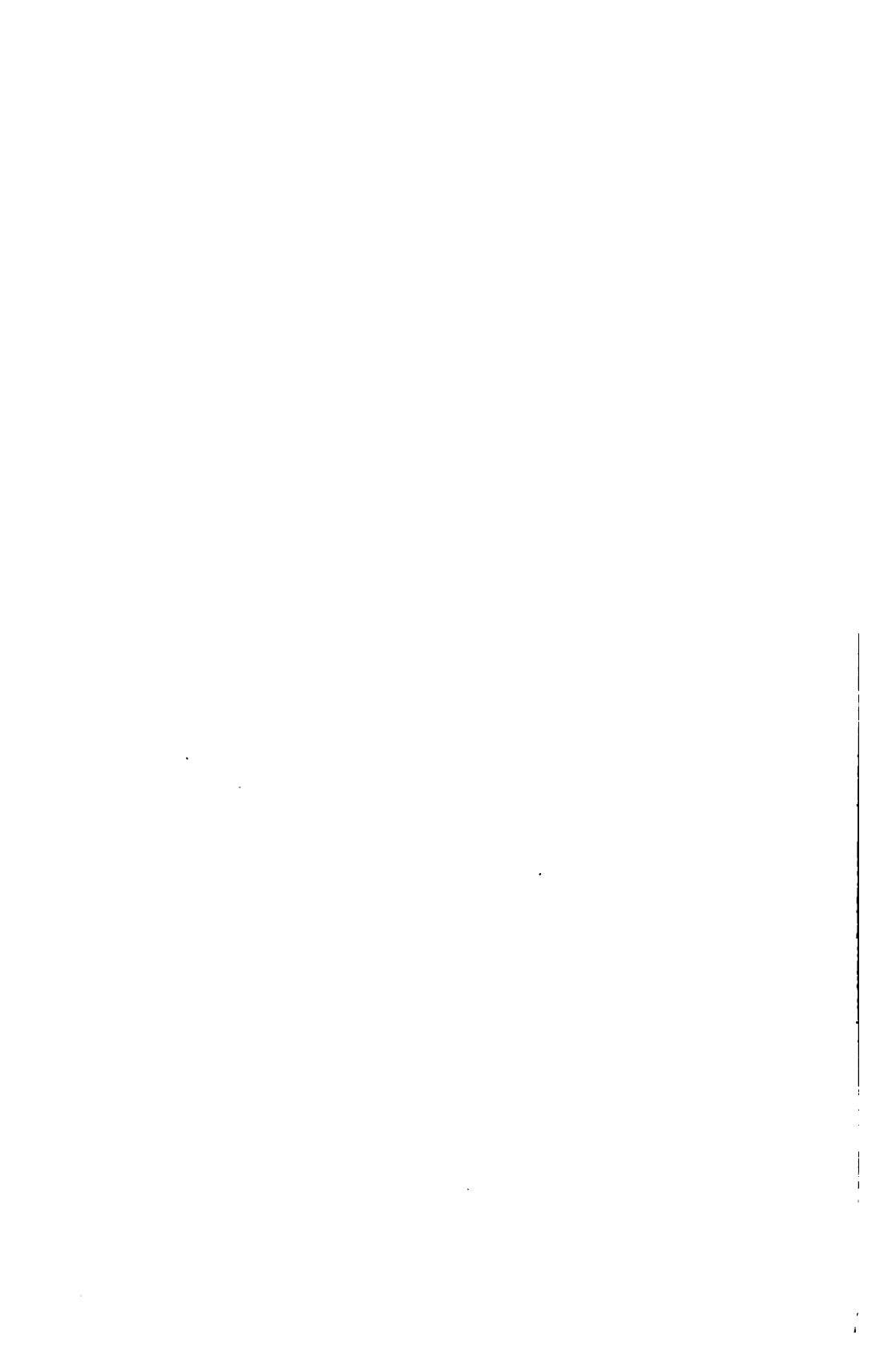

SHORT BIOGRAPHY OF DR. JOHANN KARL GAYER.

JOHANN KARL GAYER, State Councillor, and Professor of Forest Utilization at the University of Munich, D. Oec., *honoris causa*, was born at Speyer, in the Rheinpfalz, on the 15th October, 1822. He first studied Natural Science and Mathematics, and afterwards Forestry. In 1851, he managed the forests at Wiesenheim and Berg; in 1855, he was appointed second Professor of Forestry at the Forest School of Aschaffenburg. This enabled him to visit the most important forests of South Germany, and to collect material for his two classic books on Forest Utilization and Silviculture, that have had very important influence on the Science of Forestry. In 1863, the first edition of his Forest Utilization was published, the third edition in 1873, and the sixth edition in 1883. Gayer was still full of mental vigour, when, in 1902, he brought out the ninth edition of this book, with the assistance of his pupil and successor, the writer of this notice.

Gayer published his Silviculture in 1880, the fourth edition of which appeared in 1898. The silvicultural principle of the book is to preserve the natural productivity of the forest soil by the natural regeneration of woods of mixed species; this principle has been adopted by the Bavarian State Forest Department.

In 1878, part of the Forestry Instruction was transferred from Aschaffenburg to Munich, so that Gayer then became a University Professor. He was elected and became Rector of the University of Munich in 1889—90. In 1892, bodily weakness compelled him to give up teaching, but his mind remained as active as before.

Besides his two principal books he wrote the following:—
“Die neuen Wirtschaftsrichtungen in den Staatswaldungen des Spessart,” 1884; “Der bayerische Wald und schmalschlayweise Verjungung,” 1892; “Ueber den Fehmelschlagbetrieb und seine Ausgestaltung in Bayern,” 1895, etc. His work on Silviculture was translated by Bocarme into French, and by van Schermbeck into Dutch, and his Forest Utilization into English by W. R. Fisher. He was decorated by Bavaria, Russia and Greece, and was Honorary Member of several Forestry Societies. He died on the 1st of March, 1907, honoured and lamented by thousands of his pupils, friends, and by foresters all over the world.

H. MAYR.

TABLE OF CONTENTS.

PART I.

HARVESTING; CONVERSION AND DISPOSAL OF PRINCIPAL FOREST PRODUCE; WOOD.

CHAPTER I.

PROPERTIES OF WOOD.

| | PAGE |
|---|------|
| A. ANATOMY OF WOOD, ITS STRUCTURE AND TEXTURE; IDENTIFICATION OF WOODS | 7 |
| (A) Broadleaved woods | 19 |
| (B) Coniferous woods | 36 |
| (C) Palmwoods | 42 |
| (D) Bamboos | 43 |
| B. PHYSICAL PROPERTIES OF WOOD | 43 |
| 1. Colour | 43 |
| 2. Lustre | 47 |
| 3. Scent | 47 |
| 4. Hardness | 48 |
| 5. Specific Weight | 50 |
| 6. Coherence | 65 |
| 7. Hygroscopicity | 66 |
| 8. Practical results of warping | 72 |
| 9. Effects of heat on wood | 75 |
| 10. Conductivity of wood | 78 |
| (a) For heat | 78 |
| (b) For electricity | 78 |
| (c) For sound | 78 |
| (d) For light | 79 |
| C. CHEMICAL PROPERTIES OF WOOD | 79 |
| D. MECHANICAL PROPERTIES OF WOOD | 83 |
| 1. Fineness of grain | 83 |
| 2. Fissibility | 86 |
| 3. Strength | 88 |
| 4. Toughness or pliability | 95 |
| 5. Durability | 97 |

| | PAGE |
|---|------|
| D. MECHANICAL PROPERTIES OF WOOD— <i>cont.</i> | |
| 6. Heating-power and combustibility | 107 |
| 7. Aptitude for being worked | 111 |
| (a) By implements | 111 |
| (b) By grinding into pulp | 115 |
| (c) By polishing | 115 |
| (d) Wood-bleaching | 115 |
| (e) Staining | 116 |
| (f) Pyrography | 116 |
| (g) Charcoal-making | 116 |
| (h) Impregnation | 116 |
| 8. Dimensions of trees | 117 |
| 9. Shape of trees | 119 |
| 10. Yield of the chief species | 124 |
| E. DEFECTS IN WOOD | 124 |
| 1. Defective structure | 124 |
| (a) Abnormal tissues | 124 |
| (b) Abnormal direction of fibres | 128 |
| (c) Defects in sound wood | 138 |
| (d) Diseased wood-fibres | 141 |
| 2. DEFECTS IN THE PHYSICAL PROPERTIES OF WOOD | 142 |
| (a) Discolouration | 142 |
| (b) Abnormal scents | 148 |
| (c) Diminished hardness and sp. weight | 148 |
| (d) Defects in economic properties | 148 |
| (e) Defects in chemical properties | 154 |

CHAPTER II.

FELLING AND CONVERSION OF WOOD.

| | |
|---|-----|
| SECTION I.—MANUAL LABOUR | 156 |
| 1. General remarks | 156 |
| 2. Demands on woodcutters | 158 |
| 3. Wages | 162 |
| 4. Organisation of Labour | 168 |
| 5. The forest labour-question | 172 |
| SECTION II.—WOODCUTTERS' IMPLEMENTS | 174 |
| 1. Hewing implements | 174 |
| 2. Saws | 181 |
| 3. Tools for splitting wood | 194 |
| 4. Implements for extracting and splitting stumps and roots | 197 |
| SECTION III.—SEASON FOR FELLING | 204 |
| 1. Climatic conditions | 204 |
| 2. Available labour-force | 205 |
| 3. Mode of felling | 205 |
| 4. Quality of out-turn | 207 |
| 5. Species of tree | 207 |
| 6. Special application of material | 208 |

TABLE OF CONTENTS.

xvii

| | PAGE |
|--|------------|
| SECTION III.—SEASON FOR FELLING—<i>cont.</i> | |
| 7. Modes of Transport | 208 |
| 8. Demands of timber-market | 208 |
| 9. Summary | 209 |
| SECTION IV.—METHODS OF FELLING | 211 |
| 1. General account | 211 |
| 2. Modes of felling | 212 |
| (a) Utilization of the stem | 213 |
| (b) Utilization of roots and stumps | 217 |
| 3. Felling rules | 223 |
| SECTION V.—ROUGH CONVERSION | 229 |
| 1. Mode of conversion to be applied | 231 |
| 2. Timber assortments | 235 |
| 3. The work of conversion | 239 |
| (a) Timber | 240 |
| (b) Firewood | 245 |
| 4. Removal of wood before conversion | 252 |
| 5. Occasional non-conversion of firewood | 252 |
| 6. General rules regarding conversion | 253 |
| SECTION VI.—SORTING AND STACKING CONVERTED MATERIAL | 254 |
| 1. General account | 254 |
| 2. Detailed account | 255 |
| 3. List of wood assortments | 257 |
| SECTION VII.—CLEARING THE FELLING-AREA | 262 |
| 1. Explanation of the term | 262 |
| 2. Purpose of the clearance | 263 |
| 3. Choice of a forest-depot | 263 |
| 4. Material to be removed | 264 |
| 5. Modes of clearance | 265 |
| 6. Season for clearance | 280 |
| 7. General rules | 282 |
| SECTION VIII.—SORTING CONVERTED MATERIAL AND FIXING SALE- | |
| LOTS | 284 |
| 1. Single pieces forming a lot | 284 |
| 2. Number of pieces forming a lot | 285 |
| 3. Stacked wood | 285 |
| 4. Protecting the forest-depot | 290 |
| SECTION IX.—ESTIMATING THE YIELD | 291 |
| 1. Numbering the lots | 291 |
| 2. Estimating quantity of produce | 293 |
| 3. Estimating quality of produce | 296 |
| 4. Valuation | 296 |
| SECTION X.—CONCLUDING THE BUSINESS OF FELLING AND CONVER- | |
| SION | 297 |
| 1. Registry of produce from the felling | 297 |
| 2. Revision of the record | 298 |
| 3. Payment of woodcutters | 298 |

CHAPTER III.

WOOD TRANSPORT BY LAND.

| | PAGE |
|---|------|
| INTRODUCTION | 300 |
| SECTION I.—FOREST-ROADS | 301 |
| A. Construction and maintenance | 301 |
| B. Mode of conveyance | 310 |
| SECTION II.—TIMBER-SLIDES | 316 |
| " III.—FOREST-TRAMWAYS | 334 |
| " IV.—WIRE-TRAMWAYS | 346 |

CHAPTER IV.

WOOD TRANSPORT BY WATER.

| | |
|--|-----|
| SECTION I.—FLOATING | 353 |
| 1. Conditions for streams to be utilizable | 354 |
| 2. Improvement and maintenance of watercourses | 356 |
| 3. Booms | 382 |
| 4. Method of floating wood | 399 |
| SECTION II.—RAFTING | 407 |
| 1. Rafting-channels | 408 |
| 2. Rafts | 409 |
| 3. Dimensions of rafts | 415 |
| 4. Mode of rafting | 416 |

CHAPTER V.

| | |
|--|-----|
| COMPARISON BETWEEN DIFFERENT MODES OF TRANSPORT. | 420 |
|--|-----|

CHAPTER VI.

| | |
|---------------------------------------|-----|
| WOOD-DEPOTS | 429 |
| 1. Land-depots | 429 |
| 2. River-depots | 431 |
| 3. Methods of storing wood | 436 |
| 4. Registration of receipts | 439 |

CHAPTER VII.

| | |
|--|-----|
| DISPOSAL AND SALE OF WOOD | 440 |
| SECTION I.—DISPOSAL OF WOOD | 440 |
| " II.—SALE OF WOOD | 447 |
| " III.—BUSINESS PRINCIPLES INVOLVED IN SALES | 468 |

CHAPTER VIII.

| | PAGE |
|--|------|
| AUXILIARY FOREST INDUSTRIES | 482 |
| A. DETAILED CONVERSION | 482 |
| SECTION I.—SAWMILLS | 483 |
| " II.—OTHER WOOD-WORKING MACHINES | 499 |
| B. TREATMENT FOR IMPROVING WOOD | 502 |
| SECTION I.—IMPROVEMENT IN APPEARANCE AND QUALITY | 502 |
| " II.—ANTISEPTIC TREATMENT | 509 |
| " III.—ALTERING COMBUSTIBILITY OF WOOD | 523 |
| C. CHANGES IN THE SUBSTANCE OF WOOD | 525 |
| SECTION I.—BY HEAT | 525 |
| " II.—CHARCOAL KILNS | 527 |
| " III.—COMBUSTION OF WOOD | 550 |
| " IV.—CHEMICAL AGENCIES | 551 |
| (a) Cellulose | 551 |
| (b) Sugar and alcohol | 554 |
| (c) Oxalic acid | 555 |
| (d) Bamboo-fibre | 555 |

CHAPTER IX.

INDUSTRIAL USES OF WOOD.

SUB-DIVISION I.—TIMBER.

| | |
|---|-----|
| SECTION I.—CLASSES OF CONVERTED TIMBER | 556 |
| " II.—TIMBER USED IN SUPERSTRUCTURES | 561 |
| " III.—TIMBER USED ON, OR IN, THE GROUND | 567 |
| " IV.—TIMBER USED IN CONTACT WITH WATER | 574 |
| " V.—TIMBER USED IN MACHINERY | 576 |
| " VI.—SHIP AND BOAT BUILDING | 577 |
| " VII.—JOINERY AND CABINET-MAKING | 584 |
| " VIII.—MISCELLANEOUS USES | 589 |
| " IX.—WHEELWRIGHTS' WOOD | 591 |
| " X.—COOPERS' WORK | 594 |
| " XI.—SUNDRY USES OF SPLIT WOOD | 600 |
| " XII.—WOOD FOR WINDOW-FRAMES | 607 |
| " XIII.—WOOD-CARVING | 608 |
| " XIV.—TURNERY | 611 |
| " XV.—PLAITED WOOD-WORK | 612 |

| | PAGE |
|---|------|
| SECTION XVI.—WOOD USED IN AGRICULTURE | 614 |
| " XVII.—REFUSE WOOD | 616 |
| SUB-DIVISION II.—FIREWOOD | 617 |
| SUB-DIVISION III.—LIVING PLANTS OR PARTS OF PLANTS | 619 |
| SUB-DIVISION IV.—WOODS ARRANGED ACCORDING TO THEIR USES | 620 |

PART II.

PROPERTIES, ULLIZATION, VALUATION AND DISPOSAL OF MINOR FOREST PRODUCE.

CHAPTER I.

| | |
|---|-----|
| BARK | 629 |
| SECTION I.—ANATOMY OF BARK | 629 |
| " II.—CHEMICAL, PHYSICAL AND ECONOMIC PROPERTIES OF BARK | 631 |
| " III.—PROPERTIES OF THE CONSTITUENT PARTS OF BARK | 633 |
| A. Tanning materials | 633 |
| B. Tannin from young oak-bark | 636 |
| " IV.—THE BARK OF OLD OAKS | 657 |
| " V.—SPRUCE-BARK | 659 |
| " VI.—BIRCH | 661 |
| " VII.—LARCH | 661 |
| " VIII.—WILLOW | 661 |
| " IX.—BARK CELLULOSE | 662 |
| " X.—CORK | 663 |

CHAPTER II.

| | |
|---|-----|
| UTILIZATION OF THE FRUITS OF FOREST TREES | 666 |
| SECTION I.—CHARACTERISTICS OF SEEDS | 666 |
| " II.—DATES OF SEED-BEARING | 669 |
| " III.—DATES OF RIPENING AND FALL | 671 |
| " IV.—HARVESTING SEED | 672 |
| " V.—SEED-HUSKING ESTABLISHMENTS | 673 |
| " VI.—STORING SEEDS | 687 |

TABLE OF CONTENTS.

xxi

| | PAGE |
|---|------|
| SECTION VII.—AVERAGE QUALITY OF SEEDS | 690 |
| „ VIII.—SALE AND DISPOSAL OF SEEDS | 691 |

CHAPTER III.

| | |
|--|-----|
| UTILIZATION OF LEAVES, TWIGS AND ROOTS OF FOREST TREES | 694 |
|--|-----|

CHAPTER IV.

| | |
|--|-----|
| PROPERTIES, HARVESTING, SELLING AND DISPOSAL OF RESIN | 699 |
| SECTION I.—ANATOMY | 699 |
| „ II.—CHEMICAL AND PHYSICAL PROPERTIES | 703 |
| „ III.—DISTRIBUTION OF RESIN IN TREES | 704 |
| „ IV.—RESIN TAPPING OF STANDING TREES | 706 |
| „ V.—YIELD OF RESIN AND EFFECTS OF TAPPING | 722 |
| „ VI.—EXTRACTION OF OIL OF TURPENTINE FROM CRUDE RESIN | 723 |
| „ VII.—COMMERCIAL PRODUCTS FROM CRUDE RESIN | 726 |

CHAPTER V.

| | |
|---|-----|
| OTHER MINOR PRODUCE FROM TREES (CAMPHOR, CONIFERIN, VANILLIN, SUGAR TREES, DYES, GUMS, LAC, CAOUTCHOUC, GUTTA-PERCHA, Etc.) | 728 |
|---|-----|

PART III.

UTILIZATION AND DISPOSAL OF MINOR PRODUCE FROM THE SOIL OF THE FOREST.

CHAPTER I.

FOREST HERBAGE.

| | |
|-------------------------------|-----|
| SECTION I.—PASTURE | 737 |
| „ II.—GRASS-CUTTING | 746 |

TABLE OF CONTENTS.

| CHAPTER II. | | PAGE |
|--|--|------|
| FIELD-CROPS IN COMBINATION WITH FORESTRY | | 749 |
| CHAPTER III. | | |
| FOREST-LITTER | | 758 |
| CHAPTER IV. | | |
| DIGGING AND PREPARATION OF PEAT | | 790 |
| CHAPTER V. | | |
| LESS IMPORTANT MINOR PRODUCE (GRASS-SEEDS, MOSSES, EDIBLE FRUITS, HERBAGE FOR INDUSTRIAL PURPOSES, EDIBLE FUNGI, Etc.) | | 824 |

 PART IV.

| | |
|---|-----|
| UTILIZATION OF COMPONENTS OF THE FOREST SOIL (STONE, GRAVEL, Etc.) | 831 |
| INDEX | 835 |

FOREST UTILIZATION.

INTRODUCTION.

4
THE annual produce of forests affords the most striking proof of their utility; it enables us to satisfy a great number of our wants, and we can never dispense with forest produce, or only do so with the greatest difficulty.

In earlier times, when forests extended far beyond human requirements and unimpaired natural forces maintained them intact without any artificial assistance, Forest Utilization comprised the whole art of forestry. Protection, tending, sowing and planting were unnecessary; superabundant supplies of forest produce were available for all possible requirements, and had only to be utilized. This was done for ages, without any regard to economy or to the wants of future generations.

An utterly wasteful utilization of forest produce continued, until a wood-famine was impending; for the demands made on agricultural produce by a steadily increasing population involved the clearance of vast areas of woodland, while the prolonged maltreatment to which forests were subjected had diminished their productiveness considerably. Unfortunately, in many countries, matters have not improved in this respect. If forests are to be maintained, the woodcutter's axe and the utilization of all forest produce must be brought under control, land suitable for producing forests should be densely stocked with trees, and forest utilization subordinated to silviculture.

Forest raw material may be utilized in various ways, but its utility will be secured most fully when each product is used for the purpose for which it is better adapted than any other available material. Then only can a forest respond properly to the interests of mankind as well as to those of its owner, for

then only will it yield the greatest pecuniary return. There was, however, a time when it was considered incompatible with good forestry to attempt to make a forest yield the best financial results; a forest was looked upon as a means of satisfying, without any speculative motive, the direct and indirect national requirements. But precisely because a forest is an important national estate, and because the importance of any estate is recognized most fully and its protection best secured when itself and its produce possess a considerable sale-value, this way of regarding forests is generally erroneous. The profit obtained from careful forest-management is small when compared with that from other productive industries, and apparently will not improve just yet, for substitutes used in place of wood come more and more into use.* So much the more, therefore, in the interests of both national economy and forestry, should every forest-owner endeavour to increase the pecuniary yield of his woodlands as much as possible, provided that at the same time he works within the bounds prescribed by good forest management. Forest utilization therefore should always keep in view the possibility of a steady improvement of the forest revenue, without prejudice to its maintenance or future enhancement.

The foregoing remarks lead us to define the science of Forest Utilization as a **systematic arrangement of the most appropriate methods of harvesting, converting and disposing profitably of forest produce, in accordance with the results of experience and study, due regard being paid to silviculture and to the best pecuniary returns.**

Wood is usually the chief product of forests, and at present the aim of forest management is directed chiefly to its production. Besides wood, there are other useful products, which are derived either from the trees or the soil of forests, or consist of the components of the latter. As most of them, however, are, in general, relatively inferior in value to wood, and their production is bound up with the existence of

* [For a statement of the financial returns from forests, *cf.* Vol. I. of this Manual, 3rd ed., p. 202. There is, indeed, every prospect of increased profits from woodlands, now that the demands for wood-pulp for papermaking have become so enormous and the prices of timber imported into Britain and elsewhere are rising steadily.—Tr.]

forests, they are considered as accessory, or minor, produce. A distinction is thus made between principal and minor forest produce.

A forest-owner is, as a rule, concerned only with the rough conversion of the produce of his forest, so as to facilitate its transport. Sometimes, however, and for certain kinds of produce, it may be advisable for him to prepare forest produce in the form in which it is directly utilizable for various industries, in which case he carries on auxiliary forest industries. To deal with these industries fully is quite beyond the province of the present book, and they will be described only in such detail as the ordinary routine of forestry requires.

The matter of which the science of Forest Utilization, thus extended, is composed, may be comprised under four principal headings, which are as follows :—

- I. UTILIZATION OF PRINCIPAL FOREST PRODUCE, WOOD.
- II. UTILIZATION OF MINOR PRODUCE FROM TREES.
- III. UTILIZATION OF MINOR PRODUCE FROM THE FOREST SOIL.
- IV. UTILIZATION OF THE COMPONENTS OF THE FOREST SOIL AND SUBJACENT ROCKS.

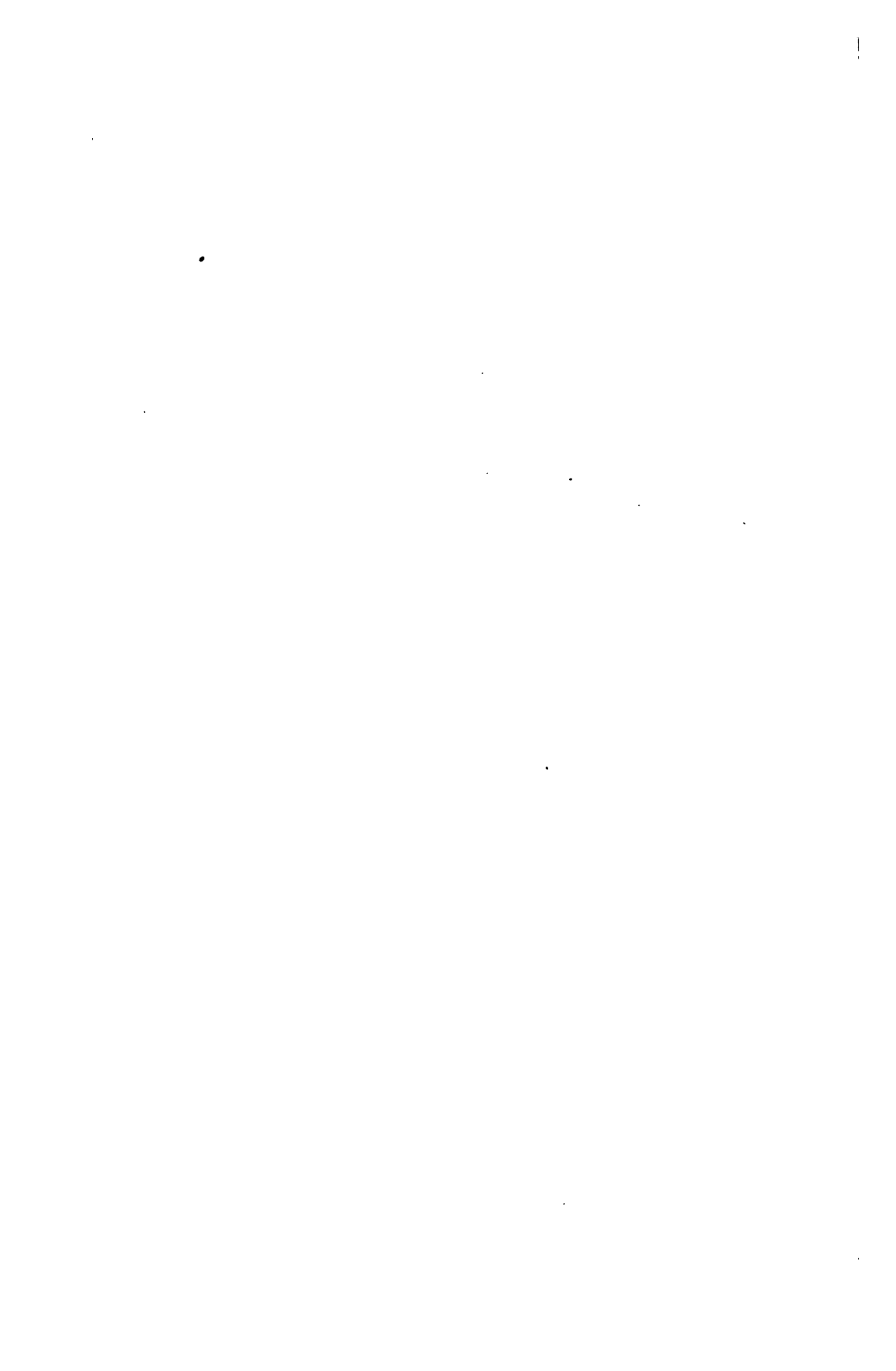

PART I.

**HARVESTING, CONVERSION AND DISPOSAL OF
PRINCIPAL FOREST PRODUCE, WOOD.**



CHAPTER I.

PROPERTIES OF WOOD.*

A. ANATOMY OF WOOD, ITS STRUCTURE AND TEXTURE; IDENTIFICATION OF WOODS.

THE elementary organs of which wood is constructed are the chief means of identifying woods; their combination, as seen in various sections, at once strikes the eye. Variations in the physical and technical properties of woods, *e.g.*, in a piece of oak as compared with a piece of spruce, also depend chiefly on their anatomical structure. We cannot, however, explain all the physical and technical differences in woods by a microscopical examination of their anatomy. The microscope does not indicate, or indicates very incompletely, the materials that determine durability of timber; it gives no information regarding brittleness or elasticity, nor how the ultimate components of the wood are arranged or react on one another. Anatomy tells us nothing about the mycellar and molecular structure of the cell-walls, the effects of which on the chemical, physical and technical properties of wood are still very obscure. But anatomy is indispensable in elucidating vital processes in the physiology of trees, in explaining the processes of the formation and decay of timber.

Microscopes are seldom necessary for identifying woods, all the characters that follow being recognizable by the naked eye. In the following plates, prepared for the new German edition of Gayer's book, structural items are reproduced in their natural size, the microscopic plates of the earlier editions having been suppressed.†

Nature has facilitated greatly the study of the structure of

* "Laslett's Timber and Timber Trees," edited by Marshall Ward, 1894; "Wood," G. S. Boulger, 1902; "The Timbers of Commerce," Herbert Stone, 1904; "Exploitation Commerciale des Bois," Mathey, 1906.

† The translator has, however, retained these plates to illustrate the microscopic account of wood-structure given further on.

wood, although at first sight it appears to be of manifold variety. This is because the same structural or anatomical data are characteristic of genera. For instance, all European, American or Asiatic deciduous oaks exhibit the same structure and anatomy; this is also true for all ashes, spruces, or firs, for all two-needle pines (*Pinaster* type); for all five-needle pines (*Cembra* type), and so on. The importance of this law is not only *positive*, by simplifying the study of the characteristic structures of woody species, but also *negative*, as it thus becomes impossible, either by the naked eye, or microscopically, to distinguish between different species of any genus; *e.g.*, in oaks, to say of what species is any wood-specimen, or from what locality it comes. Custom-house experience of recent years has thoroughly confirmed this statement.

The same anatomical differences that exist in different species of a genus, for instance between species of oak or spruce, also exist in varieties of the same species, *e.g.*, in the sessile oak, or the European spruce. Such are: breadth of sap-wood; ratio of spring-wood to summer-wood; number, height and thickness of medullary rays; mass of parenchyma, vessels, tracheids, etc. **Physical and technical characters**, such as lustre, odour, colour, durability, strength, are the only individualities of woods of nearly allied species. The first three of these characters change rapidly after a tree has been felled and converted, so that they are of diagnostic value for a short time only, while the two last can be decided only by technical experiments; their exact determination is therefore very difficult and not always practicable, nor satisfactory.

Before describing the different components of woody tissue it is necessary to give a short description of its anatomical elements, as seen under the microscope.

The cells of the pith are nearly isodiametric and by their rapid sub-division cause the longitudinal growth of shoots, in which process the cells immediately round the pith also participate, partly by division and partly by being stretched. The pith cells often lose their contents early and then contain air only; they often, however, retain their plasmic contents for a longer period, during which they serve as reservoirs for starch and

other nutritive materials. Whilst the pith is important in the growth of yearling shoots, later on, irrespective of its diagnostic value it is unimportant as a factor in the quality of most woody species. Only, as in palms, in species the annual shoots of which do not increase in thickness, is the pith of any moment in the quality of the wood.

Around the pith are some of the longest organs, vessels (trachea) and tracheids. The widening of the cells of the

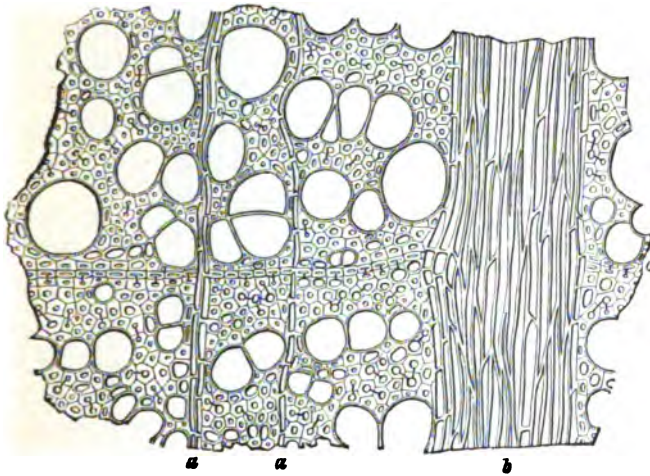

Fig. 1.—Transverse section of beechwood. Magnified 100 times.

a Narrow pith-ray. *b* Broad pith-ray. *c* Boundary of an annual ring. The large pores are transverse sections of vessels. The thick-walled elements with narrow lumina are wood-fibres; those with thinner walls and wider lumina, wood-parenchyma or tracheids. R. Hartig.

meristem, or primary growing tissue of the yearling shoot (perhaps also their lengthening), is caused by the water taken from the plasmic contents of the nascent organs. Whenever vascular cells stand one above the other, the separating transverse walls of a number of them are absorbed so as to form vessels. Various kinds of thickening then line their lumina, and they are termed spiral, annular, or scalariform vessels. As soon as the vessel has attained its normal width, during the year of its formation, its plasmic contents and the water contained in its lumina disappear. Mayr's observations are

opposed to those that represent vessels as the chief conductors of water ; they show that vessels normally never contain water, but serve exclusively for aëration and for conducting oxygen to the neighbouring parenchymatous cells, which are rich in

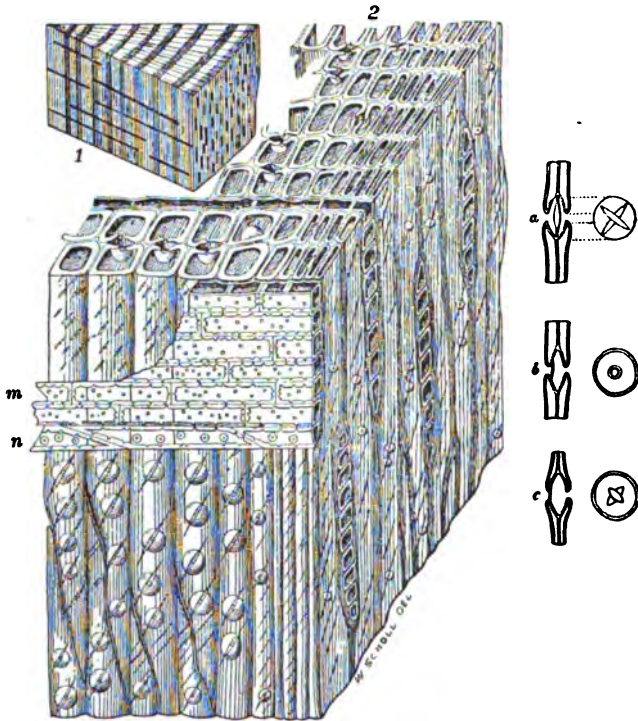

Fig. 2.—Sprucewood.

1, Natural size. 2, Small part of one ring magnified 100 times (the vertical tubes are wood-fibres, in this case all "tracheids"). *m* Medullary, or pith, rays. *n* Transverse tracheids of pith-rays, with simple pits, except in lowest row. *a*, *b*, and *c* Bordered pits of the tracheids, enlarged. Hartig.

plasma. For this and several other reasons, the theories of R. Hartig * ascribing the formation of abundant spring-wood to the great demands of a tree for water are considered erroneous, and so is his treatise regarding the influence of nutriment and transpiration on the strength of wood, as if that depended on the volume of all the vessels in a tree.

* R. Hartig, " Holzuntersuchungen." Berlin, 1901.

The parenchymatous cells are usually brick-shaped ; they are more rarely fibres with simple thinnings, termed pits, in their walls. These pits are small whenever parenchymatous cells adjoin one another, but large when they adjoin air-conducting vessels. The parenchymatous cells retain their contents in conifers, until the sapwood becomes converted into heartwood ; in broadleaved wood they do so still longer : they are concerned with the storage and chemical conversion of nutritive material, and probably also with water-transport. According to the order of their arrangement, there are bands of parenchyma extending radially, termed **medullary rays** ; also **longitudinal parenchyma** extending vertically alongside the vessels, but sometimes scattered in the wood, especially in the last layer of the summer-wood, and enclosing **resin-ducts**.

Of the elongated, spindle-shaped cells there are three forms, **tracheids**, **bordered-pitted cells**, and **libriform or sclerenchymatous fibres**. The first two form the wood of conifers, but also occur in broadleaved wood ; during their first year, after their walls have thickened, these elements lose their contents, conduct only air and water, and are occupied chiefly with water-transport. **Libriform or sclerenchymatous fibres** are cells with highly thickened walls and very small simple pits ; they lose their contents in their first year and conduct water and air only, being employed for water-transport ; they do not occur in conifers.

Fibrous cells are spindle-shaped parenchymatous cells with similar functions to those of sclerenchyma.

It is easy to see that all the above organs, especially those with thick walls, tend to strengthen the wood, but the lateral union of the cell-forms in the woody tissue is no less important than the structure of the cells for the strength of wood.

The construction of the bole of a tree is explained best by observing the formation of an annual shoot, which is similar to that of a herbaceous plant. This in trees is a prolongation of the previous year's shoot and is connected with all the lower parts of the tree, down to the root-tips.

If from a bud, *e.g.*, of a spruce, the scales are removed, a

little vegetating spheroid is exposed, constructed of thin-walled isodiametric cells, the meristem, or primary tissue, from which all other cell-forms spring. In this bud, when the growing-season commences, a central cylinder by rapid cell-division lengthens the bud into a shoot, whilst the externally surrounding cells (forming with the oldest vessels described lower down the **medullary sheath**) participate in the longitudinal growth, partly by cell-division, and partly by being stretched. At different points outside this cylinder, which becomes the pith (Fig. 3, *M*), the cells are stretched but not

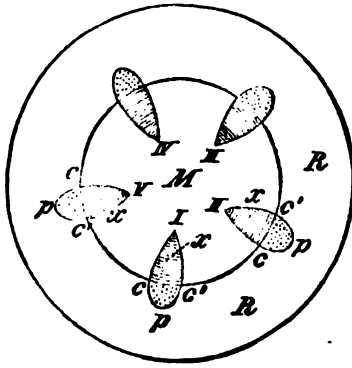

Fig. 3.—Diagram showing the position of the woody bundles, *I, II*, etc.

c, c' Cambium. *x, x* Xylem or wood.
p, p Phloem or bast. *M* Pith. *R* Cortex. *M, R* Medullary ray.

divided, so that elongated organs are formed, clearly differing from the pith but immediately adjoining it and termed **vessels** or **trachea**. They are followed by other wider vessels and other lignified cell-forms, so that the new strand of tissue is termed a **vascular** or **woody bundle** (Fig. 3, *I, II*, etc.). Each of these bundles terminates externally with a group of cells, which are not lignified, the **bast** or **phloem** (Fig. 3); between this and the woody parts termed

xylem, adjoining the pith, a meristem, the **cambium**, remains (Fig. 3, *c', c*). The cambium in the first year increases the width of the woody bundles, producing bast-cells externally and internally wood-cells. Between every two adjacent bundles a narrow band of primary tissue unites the cortex (*R*) with the pith. These bands are termed **medullary**, or **pith rays**, being parenchymatous groups of cells. Within each medullary ray, also during the first year, and originating with the cambia of the bundles, **inter-fascicular** or **medullary cambium** connects the latter into a closed zone, forming in a transverse section a ring; it consists of only a few cells in each medullary ray. The shoot terminates its upward growth by a new bud, its

transverse growth, owing to the activity of the cambium, by a stiffly constructed mass consisting chiefly of wood (Figs. 4 & 5, *I*), inside which on transverse sections is the pith, and outside, the cortex, while it contains the interposed cambium, the primary medullary rays (*a a*), and the secondary rays (*b*), which have no connection with the pith.

In the second and all subsequent years, a new woody zone, external and adjacent to the first year's zone, is formed by the cambium; it surrounds all the growing points of the yearling plant, the leading shoot, the branches and roots (Fig. 6).

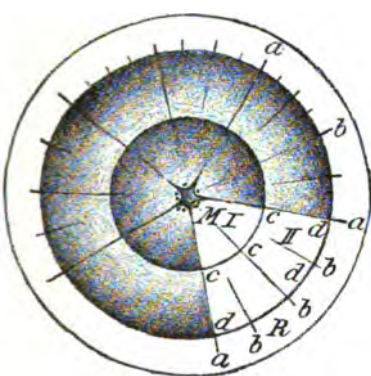

Fig. 4.

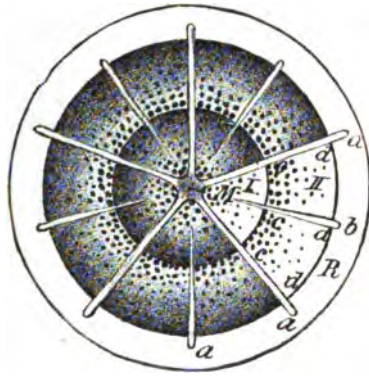

Fig. 5.

Diagrams of transverse sections of a two years' shoot, coniferous (4), and broadleaved (5).

I The first annual zone. *II* The second annual zone. *M, a* Primary, *M, b* secondary, medullary rays. *c, c* Spring-wood. *d, d* Summer-wood. *R* Cortex. $\frac{1}{1}$

On section *c* (Fig. 6) of the two concentric annual zones of the plant, two concentric circles appear, the inner circle surrounding the medullary sheath with the pith in its centre and forming the first annual ring; the outer circle surrounds the second year's zone and is the second annual ring. Thus, every year a concentric zone of wood is produced, and by counting these zones on a transverse section of wood its age can be determined.

The annual zones of certain trees exhibit differences in their anatomical structure, *e.g.*, in oaks and ashes, the vessels at the commencement of each year's zone are wider than those

formed later on towards the close of the growing season, so that a wide-pored early wood may be distinguished from

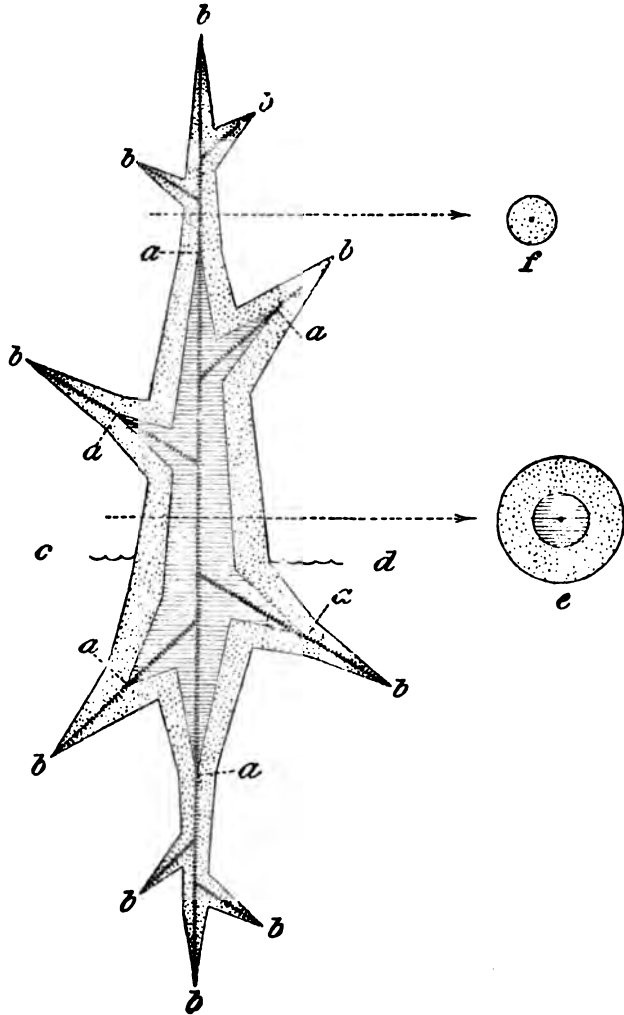

Fig. 6.—Diagram of a shoot, showing first year's growth (lined), and second year's growth (dotted).

a Terminal shoot, first year. *b* Terminal shoot, second year; dark line, pith. *f* Section of first year's growth. *e* Section of second year's growth. *c, d* Surface of ground.

the narrow-pored late wood of the preceding year, a fact that facilitates the counting of the annual zones. Hence

Nördlinger termed such woods ring-pored [Fig. 5, II, c, spring-wood with wide pores (sections of vessels), I, d, summer-wood with narrow pores; between them is the annual ring]. The term *ring-pored* is not happily imagined, as it is doubtful whether some woods are to be termed ring-pored, or not; the term *scattered pores* is also unsatisfactory, for the wood of oak and ash also possesses pores, though smaller ones, outside the ring of large pores; for this reason, in the following attempt to classify woods, the use of these terms is abandoned, though they may be serviceable for descriptions and tables of identification when unaccompanied by plates.

In some other broadleaved trees, as in elms and cherry-trees, the early wood is richer in pores than the late wood; in others again, such as beech, birch, lime, etc., there is no distinction between the early wood and late wood in this respect, so that it is more difficult to count their rings. In coniferous woods (Fig. 4) vessels occur only in the medullary sheath, and the annual zone begins with a thin-walled, light-coloured soft tissue, which gradually, seldom abruptly, passes over into a thick-walled, dark-coloured, hard, late wood, with narrow lumina. Hence (Fig. 4, II, c) light-coloured soft early wood directly adjoins the hard, dark-coloured late wood of the previous year. In conifers therefore there are fairly recognizable annual rings, which facilitate the determination of the age of the tree.

Owing to the important bearing of the softer early wood and the harder late wood on the different qualities of wood, attempts have been made to determine more precisely, within the annual zone of wood, the periods which produce these layers. The formation of wood during spring, *i.e.*, in Central Europe from about the end of April till the end of May (in northern latitudes or higher altitudes from June), has been termed **spring-wood**, while the wood formed subsequently during the same year, is termed **summer-wood**, or autumn-wood. As no wood at all is formed in North Europe during autumn, the latter term must be abandoned.

With a rapid diameter growth and wide annual zones the soft spring-wood of conifers grows more quickly than the summer-wood; with broadleaved woods, on the contrary, wide annual zones imply hard wood, and narrow zones, soft

wood. This question will be discussed fully under the heading, "Weight of wood." Only when the whole annual zone consists of merely two cells, as in very suppressed stems, one may be termed the early cell and the other the late cell, and these, naturally, can be seen only through a microscope.

The commencement of the non-growing season is characterised by the close of the annual ring, by the suspension of cell-division in the cambium, by the emptying of the plasmic contents of all wood-cells except those of the parenchyma; deciduous foliage loses its green colour and falls several weeks after the completion of the annual zone of wood. The shorter the period of rest, the less distinct are the signs of the annual rings in broadleaved wood. In sub-tropical, evergreen oaks there are no ring-pores; woody species in the tropics, where there is no season of rest for vegetation, have a complete period of cessation in the growth of wood whenever the tree in question loses its leaves, even if this should be but for a short period; should leaf-fall recur annually at stated times, for instance during the dry season, annual zones of wood are formed, as in the wood of teak, of several tropical leguminous trees, etc. In most tropical woods, traces of zones resembling annual rings may be seen on a transverse section, but they cannot be considered as such, any more than similar formations in the wide late wood of pines, especially of the most southern species.

The formation and structure of the wood of monocotyledonous plants, palms and bamboos, differs from that of broadleaved trees and conifers. In **palm-wood** (Fig. 27) the commencement of wood-formation is also in the bud; isolated vascular bundles appear in a pith-like primary tissue, as continuations of the vascular bundles (ribs or nerves) in the leaves, which spring from the single, unbranched, stem. These bundles are not, however, arranged in a circle, do not become united by a cambium, and are therefore unable to form a cambium for future diametric growth. In the transverse section of a palm-stem, the thickest vascular bundles are those that are innermost; outwardly they increase in number but are smaller, so that the outermost layer of a palm-stem is the hardest; the thin outer

cortex also becomes rich in silica. As the vascular bundles from the leaves bend inwards towards the interior of the stem and then outwards, the isolated brown or black bundles passing here and there through the wood afford a striking characteristic of palmwood (Fig. 27).

In **Bamboos**, numerous buds spring annually from underground rhizomes and grow in a few weeks into tall leafy shoots (culms). The size of the buds and consequently that of the culms increases annually from the seedling stage, until for a fixed term of years an even annual culm-diameter is attained. When the culms blossom and fructify, the whole plant dies, including the rhizomes. As in bamboos the pith of the buds is segmented or chambered, when it extends into the culms hollows occur separated by solid transverse walls at the nodes, whence the culm-sheaths (modified leaves) spring (Fig. 28). The length of an internode, or the distance between the bases of consecutive culm-sheaths, is therefore a measure of the activity of the growth. The culm-sheaths soon fall, and their scars are visible externally as ring-like projections (nodes), and at the axils of each sheath, or of the upper ones, leaf-bearing branches spring from a depression in the culm. Owing to their internal transverse walls, the culms are utilizable for many purposes, while their lightness and extraordinary strength add much to their utility; their strength is largely due to the large number of vascular bundles with scarcely any vessels, that are crowded together near the periphery of the culm with very little intervening parenchyma.

A knowledge of the structural data of species of woods, as well as their identification, is best secured by using three sections made in different directions. The first of these (Fig. 7, *H*), a **cross** or **transverse** section, is cut perpendicularly to the pith or longitudinal axis of the wood: in this section the **medullary rays** *M, M* appear cut through longitudinally, the vessels (at *a, c, d*) cut transversely in their width; the **annual rings**, owing to differences in adjacent structure, are most distinct in this section. Hence most authors, who deal with the identification of woods or the study of wood-structure, show transverse sections only. Nördlinger* is the chief writer

* H. Nördlinger, "Querschnitte von 100 Holzarten, 1852, erweitert, 1883, mit fremdländischer Holzarten zu 11 Bänden."

following this plan; his transparent wood-sections afford splendid material for studying the anatomical structure of wood; R. Hartig* gives plates of somewhat enlarged sections, and his pamphlet is better written and more practical than Nördlinger's book. Dr. Möller† also has published an excellent pamphlet with good plates on the structure of wood.

The transverse section is, however, but rarely exposed in utilized wood, which usually occurs in longitudinal sections cut more or less parallel to the axis of the tree. These sections also show the wood-texture best; foresters should recognize European and the more important foreign woods, not only by transverse sections, but also by the more important longitudinal sections. The radial or silver-grain section, more or less in the plane of the medullary rays and radially inclined to the pith (Fig. 7, *S*), shows the vessels as finely carved grooves or lines, of various lengths, the medullary rays along parts of their length perpendicular to the annual rings, and in their height or breadth; the annual rings are less sharply defined than in the transverse section, but still sufficiently distinct. The other longitudinal section is more or less tangential to an annual ring, it is termed the tangential section (Fig. 7, *T'*): on it the vessels appear as grooves of various length, the longer, the nearer is the cut to the true tangent; the medullary rays (Figs. 7 and 8, *T', e*) are cut transversely and show their height and thickness; the annual rings appear as wavy bands that greatly improve the appearance of the wood-texture, so that economically this section is very important. Burkart (Brunn, 1881) published a collection of forty wood-species, prepared by Podany in Vienna; each species was in a frame with three compartments, one for each of the above sections. By this excellent method, a work of exceptional utility was produced, but unfortunately the edition is exhausted. A similar procedure was followed in America by R. B. Hough, of Louville, New York, which shows the American woods in three characteristic sections,

* R. Hartig, "Die Unterscheidungsmerkmale der wichtigeren in Deutschland wachsenden Hölzer," 4 Aufl, 1888. The 3rd edition of Hartig's book is translated by Somerville. Douglas, Edinburgh, 1890.

† J. Möller, "Die Rohstoffe des Tischlers u. Drechslegewerbers." I. Das Holz.

with English, French and German descriptions. Hough's collection is just as useful as Burkart's, for although his species are all American, the law already referred to holds good, that there is no difference in the anatomy or structure of American, Japanese, or European oakwood, no difference in sprucewood from these countries; also that the collection includes not only typical woods of all European species, but of many important American ones as well, such as mahogany, hickory, &c. For the same reason, Japanese wood-collections are serviceable also for European study, for the Japanese possess all our genera of trees and many others besides, and have also studied the structure of woods.

In the following description of the structural data of the more important indigenous and foreign wood-species, the systematic arrangement followed by Nördlinger is rejected. European wood-species with the most striking structure come first, then those which have no clear characteristics, after which follow a few of the more important exotic woods. The plates, all original, show the three sections, natural-sized, of each wood. When the characters appear indistinct in the plates, they are so naturally, unless the section is magnified. The use of the magnifying-glass would have lightened the work of drawing the plates, but certainly would have diminished their utility.

[The transverse section of the pith is stellate in the oak, pentagonal in poplar, quadrangular in ash, triangular in alder, and the pith is segmented in walnuts and bamboos.—Tr.]

(A) Broadleaved Woods.

1. *Species of Oak (Quercus).*

(Including all deciduous oaks of Europe, America and Asia.)

Transverse Section.—Thick medullary rays alternating with finer ones, they gleam in the dull surrounding tissues. In the spring-wood is a circle of wide vessels (pores), usually two along a radius; the vessels rapidly decrease in width towards the summer-wood and are arranged in radial rows. In the summer-wood they often bifurcate, and are visible because they are surrounded by a lustrous, pale circle of parenchymatous cells. Between these bright radial lines of

vessels and parenchyma there run, in fine sections, as in Fig. 7, fine bright bands of parenchyma parallel to the annual rings: in very slowly grown wood (Fig. 8), these are hardly visible without a magnifying glass.

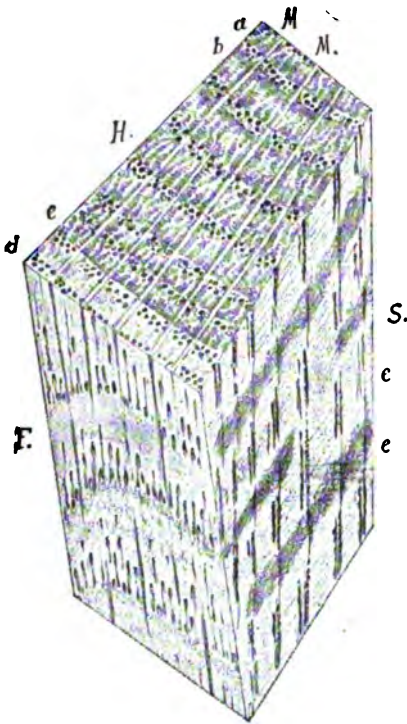

Fig. 7.—Type of Oakwood (*Quercus*).

H Transverse section. *S* Radial section.
F Tangential section. *M, M.* Medullary rays. *d, e* Sapwood. *e, a* Heartwood.



Fig. 8.—Narrow-zoned oakwood. Each ring bordered by a zone of wide vessels.

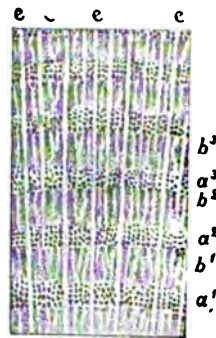

Fig. 9.—Wood of the red oak.

*a*¹, *a*², *a*³ Zones of springwood. *b*¹, *b*², *b*³ Zones of summerwood. *e, e, e* Medullary rays.

Radial Section.—The pores appear as depressions like grooves, rendering the annual rings distinct; these grooves gleam slightly if the section is through heartwood, the vessels being filled with thyloses (internal growth of cells). The medullary rays show as broad bands, or as portions of bands,

PLATE I.

A. { *Sessile Oak*.—Section from a tree 190 years old (sp. gr. 0.691). Slow regular growth in a dense High Forest. Wood of best quality for cabinet-making. Forest of Moladier (Allier). Altitude 975 feet.

B. { *Sessile Oak*.—Section from a tree from near Lake Thirlmere, in Cumberland. Altitude 600 feet. Glacial drift. Slow regular growth.

C. { *Pedunculate Oak*.—Section of a tree from the Forest of Dean, where oak attains 6 feet in girth in 75 years.

PLATE I.

A } *sessilis* Oak.—Section from a tree 100 years old (sp. gr. 0.691). Slow regular growth in a dense High Forest. Wood of best quality for cabinet-making. Forest of Mollater (Alier). Altitude 975 feet.

B } *sessilis* Oak.—Section from a tree from near Lake Thirmere in Cumberland. Altitude 600 feet. Glacial drift. Slow regular growth.

C } *pedunculata* Oak.—Section of a tree from the Forest of Dean, where oak attains 6 feet in girth in 75 years.



PLATE I.
TYPES OF OAKWOOD.

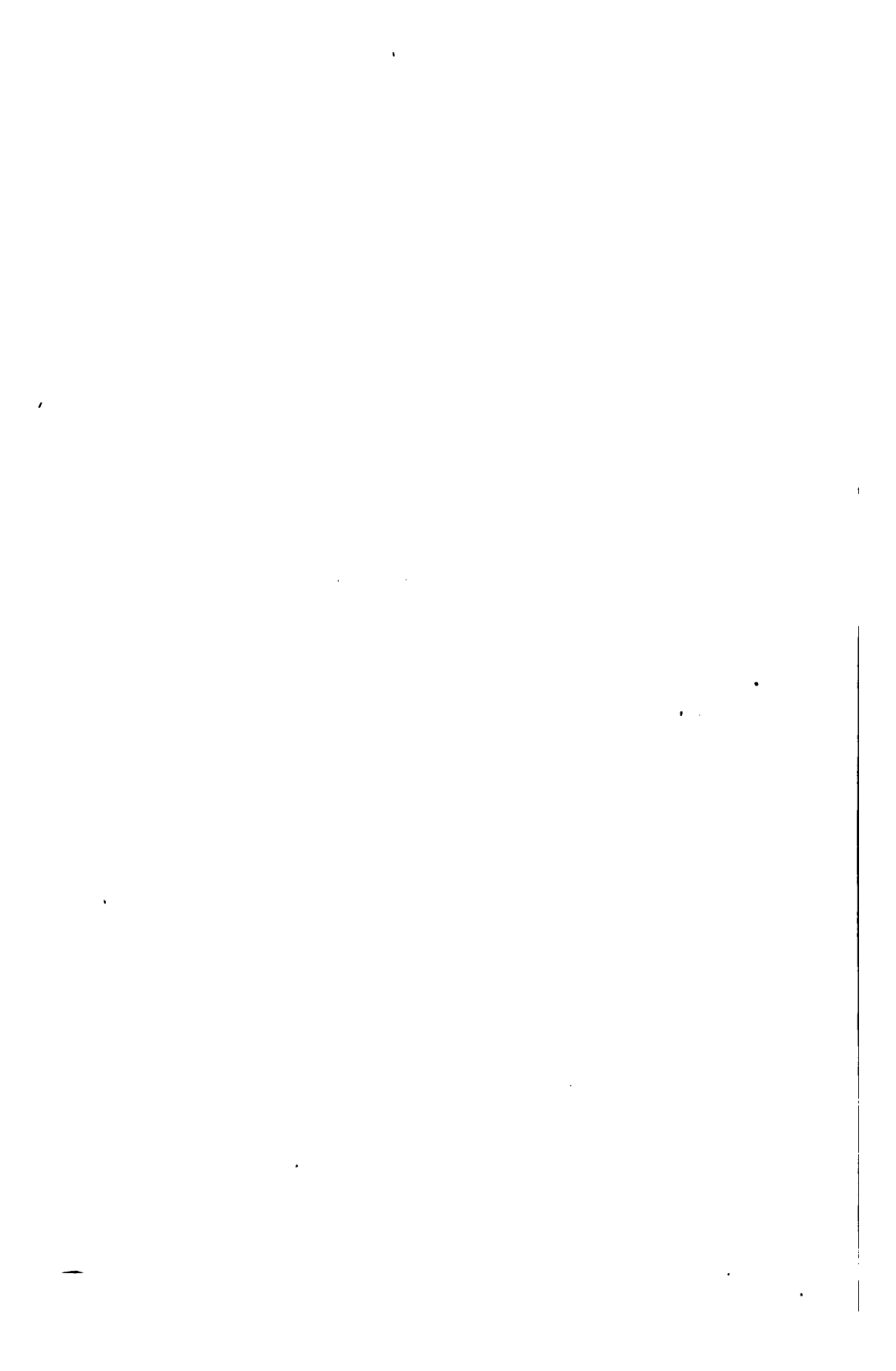

on account of the obliquity of the cut or the slightly undulating course of the rays through the wood; according to their angle of inclination to the light, the rays appear duller (Fig. 7, *S, c*) or brighter (Fig. 8) than the surrounding tissue. The annual rings are seen as dark lines on the medullary rays, the tangential parenchyma seen on the transverse section here appears as fine parallel lines.

Tangential Section.—Intersected vessels appear clearly as more or less lengthy grooves; in a curved or scalloped distribution on the section they mark the annual rings. In the summer-wood these are but slightly marked. The sections of the medullary rays are arranged vertically as long, dark, dull lines, somewhat thicker in their middle parts.

The **sapwood** is one to three centimetres broad, light-coloured: the **heartwood** of variable colour, in freshly cut wood it is somewhat useful for determining the species and country of the wood, but this is not reliable enough for commercial purposes. Heartwood of most oaks is dull brown, in red oak (*Q. rubra*) and Turkey oak (*Q. Cerris*) somewhat redder; numerous other kinds of oakwood are known in commerce, *e.g.*, thus stone-oakwood denotes hard quality, while winter and summer oakwood have respectively hard and soft woods, but not specific differences (such as *Q. pedunculata* and *Q. sessiliflora*). Black or brown oak is a dark valuable natural oakwood, that is well known in England; in Germany, the term is applied to oakwood that has laid long in river-water, or in chalybeate water. Hazel-oak is very narrow-zoned. The colour of oakwood eventually becomes darker, as do all woods.

2. *Species of Beech (Fagus).*

(In Europe, America, Asia and New Zealand.)

Transverse Section.—Pores invisible; on thin transparent sections very fine, very numerous and uniformly distributed. Rays some thick, others fine, always forming bright bands, sometimes lighter, sometimes darker than the surrounding tissue, according to the angle of incidence of the light.

Summer-wood darker than the spring-wood, hence the annual rings are fairly distinct.

Radial Section.—The borders of the annual rings are quite distinct as dark bands of variable thickness. The rays, according to the incidence of light, are light and lustrous, or dark and dull, in bands of varying thickness.

Tangential Section.—Dark bands show the summer-wood. The sections of the rays are very numerous, dark lenticular streaks.

The sapwood is very broad, the heartwood but slightly coloured, or distinctly brown; in American beechwood, very brown. In European beechwood, the heartwood becomes clearly distinct after a felling. A reddish or dark brown coloured heartwood near the pith is abnormal (*vide* p. 146). A few days after the felling, the drying of the wood outwardly from the pith becomes apparent by the lighter colour of

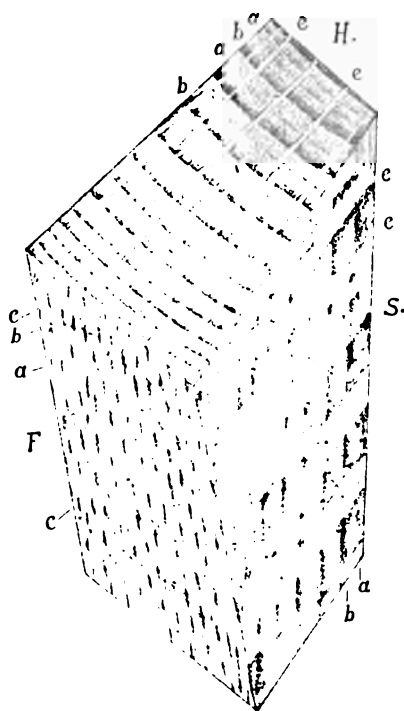

Fig. 10.—Type of Beechwood (*Fagus*).

H, S, F as in Fig. 9. *a* Spring-wood.
b Summer-wood. *c, c* Medullary rays.

the inner zones of wood; this light colour proceeds up to the bark, for the light brown colour of beechwood comes on gradually.

3. *Species of Ash (Fraxinus).*

(In Europe, America and Asia.)

Transverse Section.—Pores numerous and large in the spring-wood. In the summer-wood they are less numerous,

but small and bordered by pale parenchyma, and therefore visible as bright points in the surrounding darker tissue. Tangential parenchyma is not visible (Fig. 12B). This is the main difference between ashwood and hickory-wood, the latter possessing visible white tangential parenchyma that is parallel to the annual rings (Fig. 12A). The rays are scarcely visible. Summer-wood somewhat darker than spring-wood. Owing to the large pores, the borders of the annual rings are distinct.

Radial Section. — The borders of the annual rings are marked by curved grooves of the large vessels in the spring-wood. The medullary rays are slightly visible as very numerous, narrow, bright bands or patches.

Tangential Section. — Vessels as in the radial section, but in shorter lengths. The finer pores of the summer-wood with their parenchyma are seen only on very smooth sections, according to the angle of incidence of light, as brighter or darker fine lines. The sapwood is very broad; the heartwood (light brown) at first resembles the sapwood, but becomes darker as the wood dries.

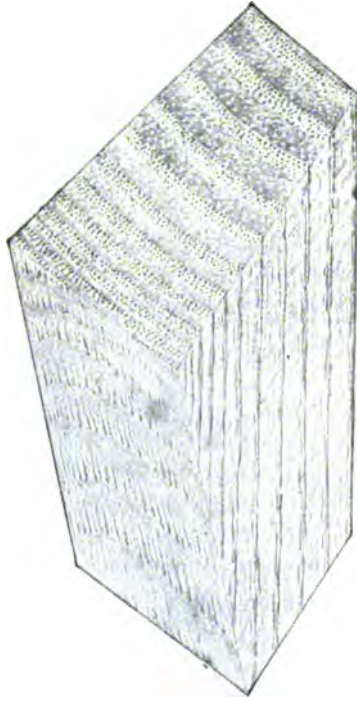
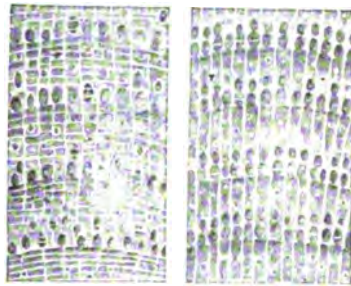

Fig. 11.—Type of Ashwood (*Fraxinus*).



A B

Fig. 12.

A Hickory-wood. B Ashwood.
(Slightly enlarged.)

4. *Species of Elm (Ulmus).*

(America, Europe and Asia.)

Transverse Section.—Pores are larger in the spring-wood than in the summer-wood, usually one or two in the radial direction, so that the annual rings are distinct. In the darker mass of the summer-wood, the pores are arranged as tangential rows of dots, which, owing to the pores being bordered by pale parenchyma, appear as peripheral wavy lines. The rays are scarcely visible.

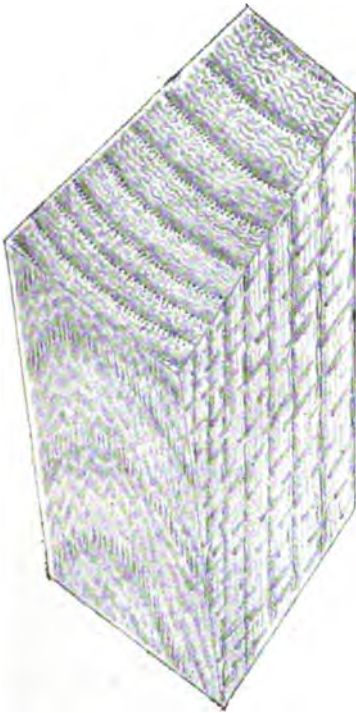

Fig. 13.—Type of Elmwood (*Ulmus*).

Radial Section.—The medullary rays show as gleaming, light brown, short bands or little streaks among the lighter, slightly lustrous mass of tissues. The borders of the annual zones are distinct, being represented by the sections of the vessels. The wavy lines of the transverse section appear as fine parallel lines.

Tangential Section.—The cut vessels are the larger, the more approximately tangential is the section,

otherwise as in the radial section. Transverse sections of the medullary rays are scarcely visible as very fine, dark streaks. The vessels and lines of parenchyma of the summer-wood are distinct as parallel zigzag lines, somewhat darker than their environment (Fig. 13).

Elms have a broad, dark brown heartwood, that on drying rapidly becomes darker.

5. *The Sweet Chestnut (Castanea).*

(America, Asia and Europe.)

Transverse Section.—Vessels somewhat larger and more numerous in the spring-wood; in summer-wood often arranged in radial, bifurcating rows, as in oakwood, and, owing to their being [surrounded by pale parenchyma,

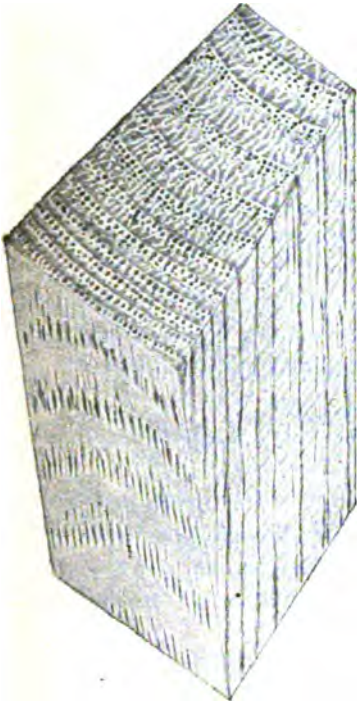

Fig. 14.—Type of Sweet Chestnut Wood (*Castanea*).

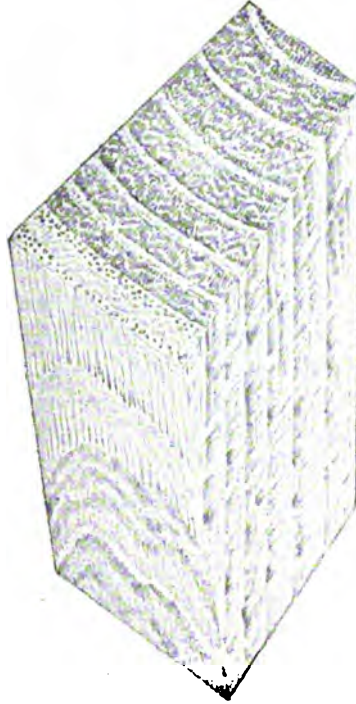

Fig. 15.—Type of Robinia Wood (*Robinia*).

they appear as whitish forked lines in the darker mass. The medullary rays are scarcely visible.

Radial Section.—The annual rings are distinct, owing to the sections of the vessels; the medullary rays are faintly recognizable as short, bright portions of bands.

Tangential Section.—The vessels and annual rings as in the radial section (showing five years' growth in Fig. 14).

Wavy lines of finer vessels and surrounding parenchyma scarcely recognizable.

6. *The Robinia or False Acacia (Robinia).*

(This includes other Papilionaceae, such as *Gleditsia*,
Laburnum, etc.)

Transverse Section.—The pores in the spring-wood somewhat wider than in the summer-wood; in the sapwood (Fig. 15, left-hand) open, and therefore dark in the plate, but closed by thyloses in the heartwood, so that they are but slightly visible in the pale yellow spring-wood. The vessels in the darker summer-wood are surrounded by pale parenchyma, and appear as wavy or zigzag lines. The spring-wood is pale and porous, so that the annual rings are distinct. The medullary rays appear as pale, fine lines.

Radial Section.—The borders of the annual rings are quite distinct, owing to the open grooves of the vessels in the sapwood, and the pale zones of spring-wood in the heartwood. The rays are distinct as bright, pale portions of bands. The parenchyma of the summer-wood appears as bright longitudinal lines.

Tangential Section.—The vessels of the sapwood and heartwood appear as in the radial section; the parenchyma of the summer-wood, as wavy bands parallel to the annual rings, brighter or darker than the mass of the wood according to the angle of incidence of light.

Robinia.—The sapwood is narrow; the heartwood light yellowish-green, becoming later brownish-green.

Gleditsia.—Sapwood broad; heartwood rose-coloured.

Laburnum and Cladrastis.—Very narrow sapwood; heartwood reddish-brown.

7. *Species of Walnut (Juglans).*

(Represented by six species in America, Asia and Europe.)

Transverse Section.—The pores are pretty evenly distributed throughout the annual zones, but sometimes more

abundant in the spring-wood; they are also larger in the spring-wood. The summer-wood is somewhat darker than the spring-wood. Rays scarcely visible.

Radial Section.—The vessels in the spring-wood form large grooves, dark brown or nearly black; light brown in the grey walnut. Rays scarcely visible.

Tangential Section.—The annual rings are, according to the incidence of light, either bright or dark lines. The vessels as in radial section; medullary rays invisible.

Juglans nigra.—Sapwood broad; heartwood reddish-brown.

Juglans regia.—Sapwood broad; heartwood light grey to dark violet.

Juglans cinerea.—Sapwood broad; heartwood light brown to greyish-brown.

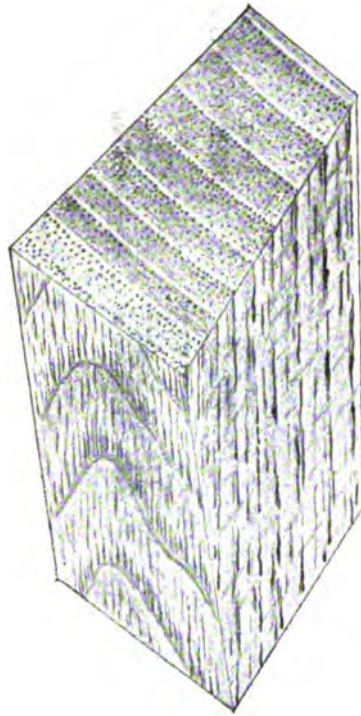

Fig. 16.—Type of Walnut-wood (*Juglans*).

8. *Species of Maple (Acer).*

(America, Asia and Europe.)

Transverse Section.—Spring-wood is pale, summer-wood dark, so that the annual rings are clearly marked. The vessels are all very narrow and invisible. The medullary rays are numerous, and with proper light-incidence appear as pale, bright lines.

Radial Section.—Annual rings only fine dark lines. Medullary rays, according to angle of light-incidence, either pale or dark bands, or specks, silky, narrow and very numerous.

Tangential Section.—Annual rings only wavy dark bands varying in breadth with the direction of the cut. Medullary rays visible as very numerous short streaks, darker than the surrounding tissue.

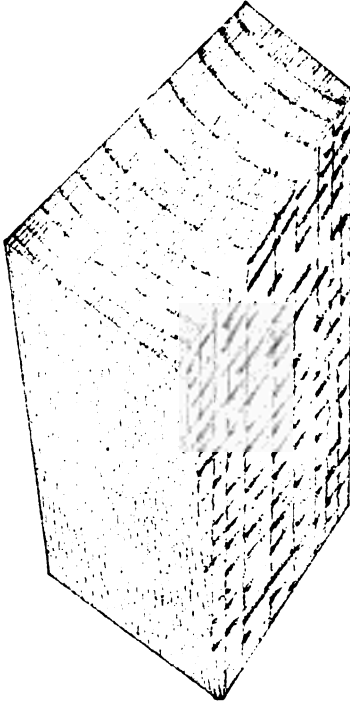

Fig. 17.—Type of Maplewood (*Acer*), and wood of Cherry or Plum (*Prunus*).



Fig. 18.—Type of Hornbeam-wood (*Carpinus*).

Sapwood broad; heartwood bright brown, subsequently becoming darker.

9. *Species of Cherry and Plum (Prunus).*

(American, Asiatic and European.)

These woods greatly resemble that of maples in their structural elements. The spring-wood exhibits a great number of fine vessels, which render the annual rings distinct. Differences consist chiefly in the colour of the woods, plum-wood being yellowish-brown and cherry-wood of a reddish tint in the heartwood, with a broad sapwood.

10. *Species of Hornbeam (Carpinus)*

(American, Asiatic and European.)

Transverse Section.—The ordinary medullary rays are very fine and hardly visible; where several unite to form a band, a dull, broad, compound ray occurs. The number of these broad rays is very variable, depending on the individuality of a tree and its locality; many pieces of hornbeam-wood have no broad rays, while in other pieces they are numerous. They traverse the wood in slightly curved lines, owing to the waviness of the annual zones. The annual rings are not very distinct, as the summer-wood is but slightly darker than the spring-wood.

Radial Section.—The vessels, annual rings, and fine medullary rays are scarcely visible; the compound rays are dull, broad bands, or parts of bands, but are very distinct.

Tangential Section.—The zones of summer-wood appear as zigzag bands, of which broader or narrower parts may be seen, according to the direction of the section. The compound medullary rays appear as thick, dark, dull lines of various length.

Sapwood and heartwood of similar colour.

11. *Species of Alder (Alnus).*

(European, American and Asiatic.)

Transverse Section.—The vessels and fine medullary rays are invisible. The compound rays, like those of the hornbeam, are very distinct but often few in number though sometimes numerous, and thus alderwood is easily recognizable. The annual rings are fairly distinct, owing to the light sapwood and darker heartwood. The wood is easily distinguished from that of hornbeam by the heaviness of the latter.

Radial Section.—The annual rings are most distinct along the compound rays, which appear as broad dull bands, or parts of bands, running through the wood. The fine rays are scarcely visible.

Tangential Section.—The annual rings are distinct, especially at their points of intersection by the compound rays,

which appear as long, dark, dull lines. These rays resemble those of hornbeam-wood, and may attain 10 c.m. in breadth.

The sapwood is broad; the heartwood, in the grey alder, of almost the same colour as that of the sapwood, in the black alder it is reddish or yellowish-red.

Owing to the absence of any decided characters that could be reproduced in a drawing, no plates are given of the following woods. They are not, however, difficult to identify if the points brought forward are attended to.

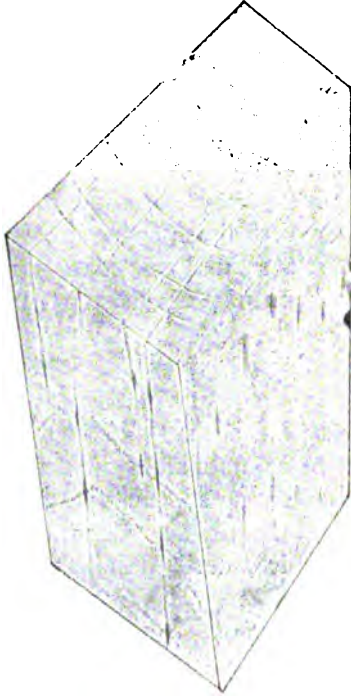

Fig. 19.—Type of Alderwood (*Alnus*).

The fine medullary rays are visible only on a sharply cut radial section. The best characteristic of the wood arises from the narrow vessels, which on the transverse section appear as fine points; on the longitudinal section, as fine lines; they are white. When one holds and turns the piece so that the light falls on it over the observer's shoulder, the annual rings then appear as thin, dark lines.

Most birches have sapwood and heartwood of the same colour, only the wood of the cherry-birch (*Betula lenta*) has a brownish heartwood.

13. Species of Lime-trees (*Tilia*).

Limewood or linden-wood shows its light yellow annual rings on every section. If the piece of wood is observed as was

12. Species of Birch (*Betula*). (European, Asiatic and American.)

The annual rings are distinct on none of the sections; a somewhat darker summer-wood marks their position feebly.

recommended above for birch, the whitish vessels are either invisible, or are seen here and there; the medullary rays are somewhat more distinct. The sapwood is broad, the heartwood slightly brown. Birchwood is always heavier than limewood. [Lime is also the name for species of Citrus.—Tr.]

14. *Species of Pear, Apple and Sorbus.*

(Including the genera *Pirus* and *Sorbus*, represented by numerous species in Asia, America and Europe.)

Decided characteristics are wanting. The medullary rays may be distinguished on good sections. Owing to the uniformity of the spring-wood and summer-wood, no valuable information is obtainable from an inspection of any of the sections. The superior hardness and specific gravity of their wood, when compared with limewood, is a useful test.

The sapwood is broad; the heartwood in applewood, reddish-brown, and browner in pearwood, in the wood of species of *Sorbus*, of a lighter yellow or brown.

15. *Species of Populus and Salix.*

The soft, light wood of poplars and willows most closely resembles that of conifers, but may always be distinguished from the latter by its numerous very fine vessels; it is distinguishable also from birchwood, which is heavier, by the whitish gleam of the pores (observed as in birchwood with a favourable incidence of light); from limewood, by the absence of bright annual rings.

The sapwood is very broad, in poplarwood of the same colour as the heartwood, but abnormal colouring owing to decay is frequent. Various species of willow possess variously tinted heartwood.

16. *Species of Horse-Chestnut (Aesculus).*

(Europe, Asia and America.)

On none of the sections is there any decided characteristic, owing to the almost homogeneous pale-yellow wood; the wood can therefore without difficulty be distinguished from that of

there are closed vessels, which are visible as bright spots. The medullary rays are scarcely visible.

Radial Section.—Vessels in the late wood show as bright lines, those in the early wood as dark shining grooves cut longitudinally. The annual rings form bright lines. The medullary rays are brighter or darker, according to the angle of incidence of light, than the slightly lustrous mass of the wood.

Tangential Section.—Alternately dark and pale bands show the season's growth; the vessels are as in the radial section.

No less frequent, but very characteristic features, are the isolated larger vessels filled with a snow-white matter, that appear in the transverse section as white points, and on the longitudinal sections as white lines. Besides the scent, resembling that of caoutchouc, the brownish-grey tint of the heartwood is noteworthy.

21. *Boxwood (Buxus)*.

(Chiefly from southern Europe, Asia and America, but also indigenous in England and France.)

Medullary rays and vessels invisible on all the sections. The annual rings appear as darker lines in the otherwise uniformly bright yellow-coloured hard and heavy wood.

22. *Olivewood (Olea)*.

(Southern Europe, America and Asia.)

Vessels and medullary rays invisible on all the sections, but differs from boxwood by inferior hardness and specific gravity; its colour is also rather pale-brown than yellow, and the annual rings are often obliterated by a brown colouring matter, which permeates the wood. By rubbing the wood, a characteristic scent resembling that of teakwood, occurring also in boxwood, is noticeable.

23. *Lignum-Vitae or Pulley-wood (Guaiacum)*.

(Tropical America.)

The annual rings are distinct on all the sections, owing to a dark brown zone. Medullary rays invisible; the vessels are

fine but distinct as dark green lines and points. The fibres change in direction from left to right and from right to left every year.

Sapwood narrow, pale, and of a dull yellow ; the heartwood olive-coloured and scented like gum.

24. *Ebony-wood* (*Diospyros*).

(Numerous species from warmer and tropical countries.)

The medullary rays are invisible, the vessels in the deciduous species are larger than in those that are evergreen ; the former have also more distinct annual zones. The sapwood of true ebony is pale and of much lighter weight (about 5 : 8) than the heartwood ; the heartwood of some deciduous species is light-grey with intervening darker tints. That of some evergreen species is either dark brown or black, or with bands of grey and black wood, as in calamander-wood (*D. quaesita*).* In black ebony (*D. Ebenum*), the vessels appear in longitudinal sections as lustrous fine dark lines, contrasting with the dull ground-tissue.

25. *Jacaranda*, † *false rosewood* (*Machaerium*).

(Brazil.)

Very large isolated pale vessels, evenly distributed ; their lumina are filled with a lustrous parenchyma resembling varnish. Colour violet to brown. Wood sweet-scented.

26. *Rosewood* (*Dalbergia*, *Thespesia*, *Calophyllum*, etc.).

(Several species from various tropical countries.)

Vessels fine, but distinct. The wood is brilliantly " flamed " with red or cherry-coloured streaks, hence its name ; the rosy colour absent in decayed spots. Medullary rays scarcely visible. [Palisandre is the French name for rosewood.—Tr.]

* Gamble, " Indian Timbers," subdivides ebony-woods as follows :—

1. Heartwood wholly black, or slightly streaked, as in *D. Ebenum*.
2. " streaked black and brown, or grey (*D. quaesita*).
3. " very small, black streaks in brown or grey wood (*D. Embryopteris*).
4. " none. Wood of various tints (*D. Lotus*). European.

† [Jacaranda is the Brazilian name for *Machaerium*. The genus *Jacaranda* is a Bignoniad of no value as wood.—Tr.]

Wavy lines of finer vessels and surrounding parenchyma scarcely recognizable.

6. *The Robinia or False Acacia (Robinia).*

(This includes other Papilionaceae, such as *Gleditsia*,
Laburnum, etc.)

Transverse Section.—The pores in the spring-wood somewhat wider than in the summer-wood; in the sapwood (Fig. 15, left-hand) open, and therefore dark in the plate, but closed by thyloses in the heartwood, so that they are but slightly visible in the pale yellow spring-wood. The vessels in the darker summer-wood are surrounded by pale parenchyma, and appear as wavy or zigzag lines. The spring-wood is pale and porous, so that the annual rings are distinct. The medullary rays appear as pale, fine lines.

Radial Section.—The borders of the annual rings are quite distinct, owing to the open grooves of the vessels in the sapwood, and the pale zones of spring-wood in the heartwood. The rays are distinct as bright, pale portions of bands. The parenchyma of the summer-wood appears as bright longitudinal lines.

Tangential Section.—The vessels of the sapwood and heartwood appear as in the radial section; the parenchyma of the summer-wood, as wavy bands parallel to the annual rings, brighter or darker than the mass of the wood according to the angle of incidence of light.

Robinia.—The sapwood is narrow; the heartwood light yellowish-green, becoming later brownish-green.

Gleditsia.—Sapwood broad; heartwood rose-coloured.

Laburnum and Cladrastis.—Very narrow sapwood; heartwood reddish-brown.

7. *Species of Walnut (Juglans).*

(Represented by six species in America, Asia and Europe.)

Transverse Section.—The pores are pretty evenly distributed throughout the annual zones, but sometimes more

abundant in the spring-wood; they are also larger in the spring-wood. The summer-wood is somewhat darker than the spring-wood. Rays scarcely visible.

Radial Section.—The vessels in the spring-wood form large grooves, dark brown or nearly black; light brown in the grey walnut. Rays scarcely visible.

Tangential Section.—The annual rings are, according to the incidence of light, either bright or dark lines. The vessels as in radial section; medullary rays invisible.

Juglans nigra.—Sapwood broad; heartwood reddish-brown.

Juglans regia.—Sapwood broad; heartwood light grey to dark violet.

Juglans cinerea.—Sapwood broad; heartwood light brown to greyish-brown.

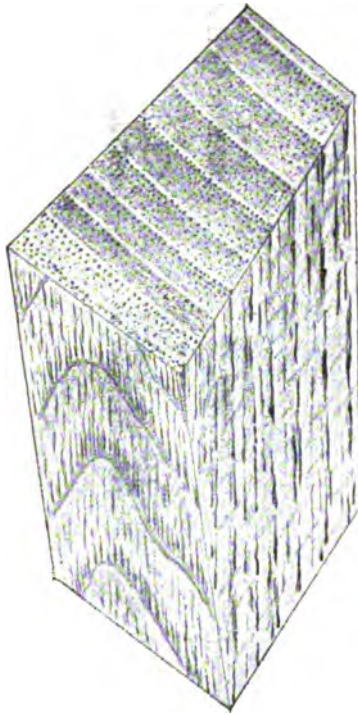

Fig. 16.—Type of Walnut-wood (*Juglans*).

8. *Species of Maple (Acer).*

(America, Asia and Europe.)

Transverse Section.—Spring-wood is pale, summer-wood dark, so that the annual rings are clearly marked. The vessels are all very narrow and invisible. The medullary rays are numerous, and with proper light-incidence appear as pale, bright lines.

Radial Section.—Annual rings only fine dark lines. Medullary rays, according to angle of light-incidence, either pale or dark bands, or specks, silky, narrow and very numerous.

Tangential Section.—Annual rings only wavy dark bands varying in breadth with the direction of the cut. Medullary rays visible as very numerous short streaks, darker than the surrounding tissue.

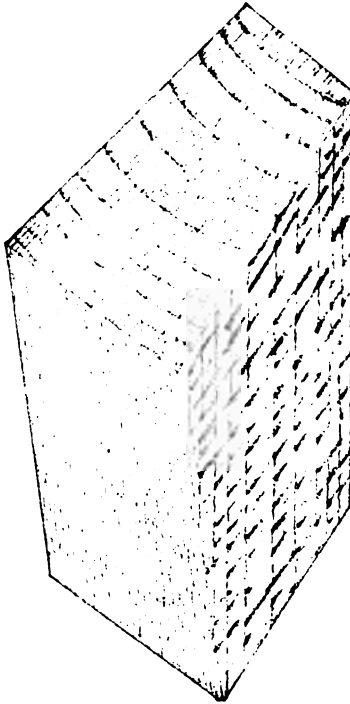

Fig. 17.—Type of Maplewood (*Acer*), and wood of Cherry or Plum (*Prunus*).

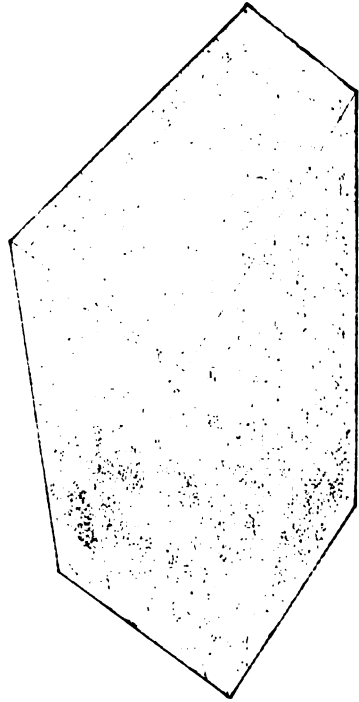

Fig. 18.—Type of Hornbeam-wood (*Carpinus*).

Sapwood broad; **heartwood** bright brown, subsequently becoming darker.

9. *Species of Cherry and Plum (Prunus).*

(American, Asiatic and European.)

These woods greatly resemble that of maples in their structural elements. The spring-wood exhibits a great number of fine vessels, which render the annual rings distinct. Differences consist chiefly in the colour of the woods, plum-wood being yellowish-brown and cherry-wood of a reddish tint in the heartwood, with a broad sapwood.

10. *Species of Hornbeam (Carpinus)*

(American, Asiatic and European.)

Transverse Section.—The ordinary medullary rays are very fine and hardly visible ; where several unite to form a band, a dull, broad, compound ray occurs. The number of these broad rays is very variable, depending on the individuality of a tree and its locality ; many pieces of hornbeam-wood have no broad rays, while in other pieces they are numerous. They traverse the wood in slightly curved lines, owing to the waviness of the annual zones. The annual rings are not very distinct, as the summer-wood is but slightly darker than the spring-wood.

Radial Section.—The vessels, annual rings, and fine medullary rays are scarcely visible ; the compound rays are dull, broad bands, or parts of bands, but are very distinct.

Tangential Section.—The zones of summer-wood appear as zigzag bands, of which broader or narrower parts may be seen, according to the direction of the section. The compound medullary rays appear as thick, dark, dull lines of various length.

Sapwood and heartwood of similar colour.

11. *Species of Alder (Alnus).*

(European, American and Asiatic.)

Transverse Section.—The vessels and fine medullary rays are invisible. The compound rays, like those of the hornbeam, are very distinct but often few in number though sometimes numerous, and thus alderwood is easily recognizable. The annual rings are fairly distinct, owing to the light sapwood and darker heartwood. The wood is easily distinguished from that of hornbeam by the heaviness of the latter.

Radial Section.—The annual rings are most distinct along the compound rays, which appear as broad dull bands, or parts of bands, running through the wood. The fine rays are scarcely visible.

Tangential Section.—The annual rings are distinct, especially at their points of intersection by the compound rays,

PLATE II.

Section from a spruce tree 200 years old (sp. gr. 0.827). Slow regular growth in a dense forest. Wood of best quality for cleaving: used for violins &c. Forest of Chamonix (Haute Savoie). Altitude 4,550 feet. } A.

Section from a larch tree. Regular structure even and moderately fast growth. Kipendavie, Tethysine. (Old red sandstone. } B.

Section from a larch tree. Very rapidly grown wood produced at a low altitude. Lord Balmora's woods near Chios. Great dolite. } C.



PLATE II.
TYPES OF SPRUCE AND LARCHWOOD.

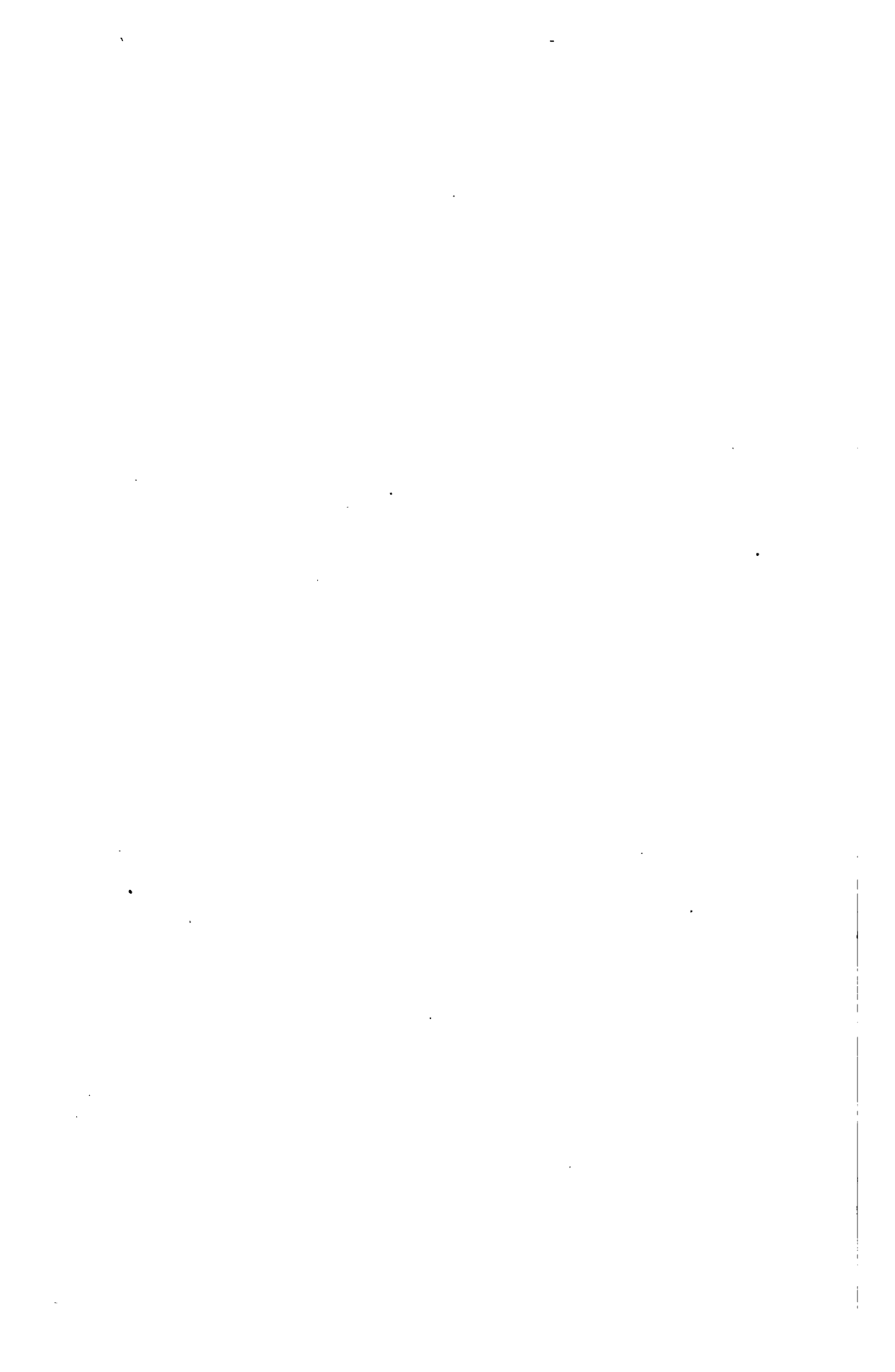

Genus Picea, species of spruce. The sapwood of moderate breadth, the heartwood contains no colouring matter so that after the sapwood has died, the sapwood and heartwood assume the same tint and remain similarly coloured. The sapwood is characterized by an exudation of turpentine, as in all woods belonging to this type.

Genus Pinus (Pinaster type).—The Pinaster pines are two-needled, with a moderately wide sapwood and slightly reddish-brown heartwood, which becomes darker after felling. The resin-ducts are somewhat larger than in spruces, and a sudden transition of spring-wood into summer-wood is commoner in these pines.

Genus Pinus (Taeda type), three-needle pines.—Sapwood variable in breadth, heartwood as in Pinaster pines, but resin-ducts larger and more distinct than in the latter (Fig. 23, wood of *Pinus palustris*, pitchpine). There is usually a more sudden transition into the broad, hard, reddish summer-wood than with Pinaster pines, to which section our Central and Northern European pines belong.

Genus Larix.—Species of larch with narrow pale sapwood and reddish-brown heartwood. The resin-ducts are always finer and less numerous than in all the above-mentioned species.

Genus Pseudotsuga.—Species of Douglas-fir. The sapwood is fairly broad, the heartwood reddish-brown, as in larch, and cannot be distinguished externally from larch heartwood. For a certain diagnosis of the wood of all the above species the use of the microscope is necessary, and exhibits such great differences in the anatomy of the medullary rays, the resin-ducts, and in *Pseudotsuga*, also in the tracheids, which (as was shown by Somerville) have, like yew, spiral thickenings, that no possible confusion can arise.

31. *Cembra* pinewood (*Pinus*, sections *Cembra* and *Strobus*).

(There are eight species of the *Cembra* type and eight of the Weymouth type in Europe, Asia and America.)

The resin-ducts on all the sections are more distinct than in the Pinaster pines, but less so than in the Taeda pines. The transition from the spring-wood to summer-wood

is gradual, and the latter is limited to a narrow zone. The sapwood is broad, the heartwood pale reddish-brown,

becoming darker on seaming. Narrow-zoned Weymouth pinewood taken from the outer zones of old trees is not distinguishable from Cembran pinewood, even microscopic observation fails to separate them.

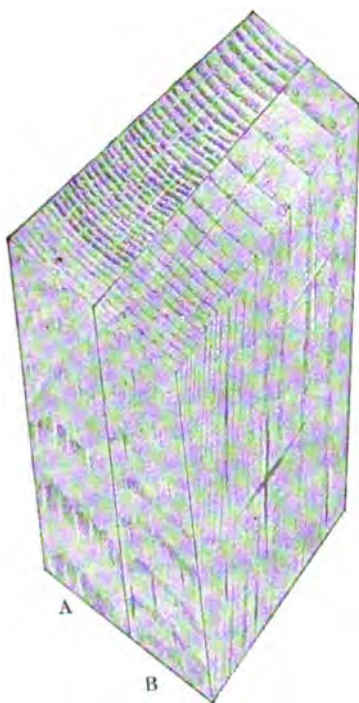

Fig. 24. — Type of Cembran Pinewood (*Pinus*, group *Cembra*), and of Weymouth pinewood (*Pinus*, group *Strobus*).

A Cembran pine. B Weymouth pine.

32. Woods of *Silver-fir*, *Abies*; of *Hemlock-spruce*, *Tsuga*; of *Taxodinae*, *Sequoia*, *Cryptomeria*, and *Taxodium*; of *Cedars*, *Cedrus*.*

The genus *Abies* includes all silver-firs in America, Asia and Europe; *Tsuga* is represented by seven species only in America and Asia; *Sequoia* and *Taxodium* in America only; *Cryptomeria* in Asia; *Cedrus* by three species or varieties in Africa and Asia.

As there are no resin-ducts,* only differences in colour and scent apparently are available in the identification of these

* [The wood of Deodar (*Cedrus Libani*, var. *Deodara*) is moderately hard, strongly scented, and very oily. The annual rings are distinct, owing to the darker summer-wood. The medullary rays are fine, unequal, and irregular, fairly numerous, and show as a silver-grain on the radial section. The resin-ducts are contiguous and arranged in concentric rows of single ducts close to the borders of the annual zones of wood. They are absent from some of these zones, and in the specimen before me appear in alternate zones only. More knowledge is required about these ducts in deodar-wood, and whether they occur also in the cedars of Lebanon and of the Atlas Mountains. Their presence in deodar-wood was reported in Gamble's "Indian Timbers," first edition (1881), but was omitted in the second edition of this book (1902). Other authorities state that cedarwood contains no ducts.—Tr.]

woods. Even microscopic observation fails owing to similarity in their structure.

Species of Silver-fir (*Abies*) are characterized by the fact that there is no colouring matter in either sapwood or heartwood; in this they resemble sprucewood, but can readily be distinguished from the latter by the absence of resin-ducts.



Fig. 25.—Type of **Silver-fir-wood** (*Abies*); of **Hemlock-spruce** (*Tsuga*); of *Sequoia*, *Cryptomeria*, *Taxodium*, and *Cedrus*.

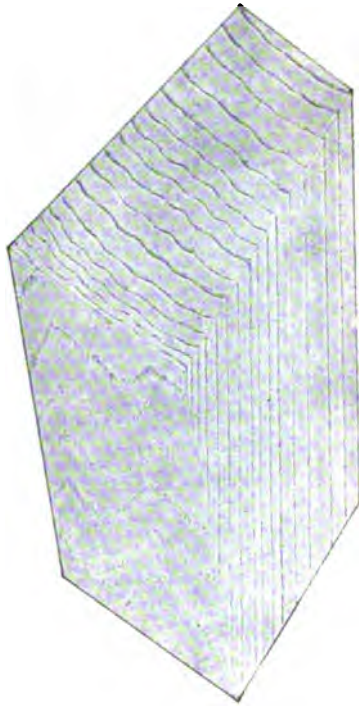

Fig. 26.—Type of **Cypress-wood** (*Chamaecyparis*, *Cupressus*, *Thuja*, *Libocedrus*, *Juniperus*, etc.).

Species of Hemlock-spruce (*Tsuga*) have a broad sapwood and a grey or greyish-brown heartwood.

In *Sequoia* the sapwood is narrow, the heartwood cherry-red, eventually becoming greyish-brown.

Taxodium has a broad sapwood and a greyish-brown heartwood; *Cryptomeria*, a broad sapwood and a reddish-brown heartwood. In cedarwood the sapwood is broad and the

heartwood yellowish-brown. There are some microscopic differences between the above-mentioned woods.

33. *Woods of the family Cupressineae (Genera, Chamaecyparis, Cupressus, Thuja, Libocedrus, Juniperus, etc.).*

There are no resin-ducts, and these woods are difficult to distinguish from those of the former groups; the finer tissues, especially in the summer-wood, and their characteristic scent, as well as differences in colour, afford a few not very trustworthy characters. Microscopic examination is also unsatisfactory.

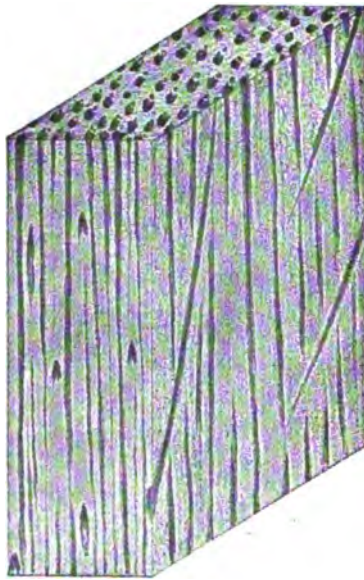

Fig. 27.—Type of Palmwood.

Lawson's Cypress (*Chamaecyparis Lawsoniana*) has a broad sapwood, a pale reddish heartwood, slightly differentiated from the sapwood, a characteristic scent. **Cham. obtusa** (Japanese) has a rose-coloured or reddish heartwood and a characteristic scent; **Cham. pisifera** (Japanese), a yellow heartwood; **Thuja plicata**, a brownish-grey heartwood in *Thuja occidentalis* the

heartwood is almost identical with the sapwood; *Juniperus virginiana* and *J. bermudiana*, Pencil-cedar, a narrow sapwood, the heartwood being bright cherry-red and becoming later yellowish-brown, with a pleasant cedar-like scent (Fig. 26).

(C) **Palmwoods.**

34. *Woods of the genera Areca, Arenga, Borassus, Cocos, Corypha, Livistona, Sabal, etc.*

Transverse Section.—Vascular bundles with thick dark brown or black wood, that is very hard near the periphery of

the stem, evenly distributed, except that they become more numerous towards the cortex, but are reduced in thickness.

Radial Section.—Some of the vascular bundles are vertical and others oblique, running inwards, or outwards (as in Fig. 27).

Tangential Section.—Some of the vascular bundles are vertical, others triangular in cross-section, and if the section cuts the bundles obliquely, they are lanceolate (Fig. 27).

Palmwoods, according to genera, exhibit bundles of various colour from rose to brown and dark black.

(D) Bamboowoods.

35. *Woods of the genera Arundinarea, Bambusa, etc.*

Transverse Section.—From the hollow outwards the vascular bundles are arranged in groups of four each, in the form of a cross, nearer the cortex they are reduced to two woody parts, the inner of which constantly increases in thickness. The number of the bundles increases towards the cortex.

Radial Section.—The vascular bundles appear as light brown or yellowish strands of varying thickness, they are also twisted into the transverse wall, that is opposite to the external projection from which a sheath-leaf has fallen (Fig. 28).



Fig. 28.—Type of Bamboowood.

To the left exterior, to the right hollow interior in the part of a transverse wall, opposite to the line of insertion of a sheath-leaf.

B. THE PHYSICAL PROPERTIES OF WOOD.*

1. Colour.

Much attention has not been paid to the colour of our indigenous woods, as only a few of them (except laburnum-

* H. Nördlinger's valuable works on wood comprise: "Der Holzring," 1872; "Die technischen Eigenschaften der Hölzer," 1860; "Die gewerblichen Eigenschaften der Hölzer," 1890.

wood and brown oak) are naturally of a fine colour; also desirable colours depend chiefly on fashion, while by bleaching, and by the use of acids and dyes, any fashionable colour can be produced. The natural colours of our woods are utilized chiefly in wood-mosaic work. Freshly felled wood, as a rule, possesses a distinct colour, which is only transitory.

It is by chemical changes only that the surfaces of planks and scantlings, at first exhibiting very little trace of colour, often rapidly acquire a decided tint, *e.g.*, black alderwood; such tints moreover cannot be fixed and are usually of no economic value. It has been surmised that these changes of colour are due to tannin acted on by oxygen, by the air and by sunlight. Colourless saps and chromogen, that are the bases of madder, indigo and litmus and become coloured by oxidation or decay, are absent from wood; some woods, such as redwood or pernambuko-wood* (*Caesalpinia brasiliensis*), contain an extractible dye. *Caesalpinia Sappan*, cultivated in Southern India and Bengal, said by Gamble to be wild in the Shan States, yields a red dye, that is much used. Logwood (*Haematoxylon campechianum*) from the West Indies and Central America, red sanders (*Pterocarpus santalinus*) from Madras, and other tropical woods, also yield important dyes. All our own woods when boiled yield a brown colouring matter (colour of brown paper).

Owing to the action of the oxygen of the air, all wood colours become gradually darker; even what is described as colourless sapwood becomes darker.

In opposition to the prevailing opinion, we class all woods into two groups from the fact that **all species of wood possess a heartwood**, whether the latter be externally discernible, owing to its being permeated by colouring matter, or not. In both these cases, the heartwood has physiological functions, which the sapwood cannot fulfil permanently (water transport). It is better to renounce such terms as **sapwood**

* [Mathey, *op. cit.*, p. 7, terms this Brazil-wood, but states that it comes from *Caesalpinia crista* and *C. echinata* of Guiana. Stone ("Timbers of Commerce") gives *Chlorophora tinctoria*, from Cuba and Brazil, as the origin of Fustic (*Gelbes Brazilholz*). Mathey mentions *Hypericum bacciferum* (yellow) and *Copaifera bracteata* (violet), Guiana.—Tr.]

trees, trees with incomplete heartwood (Reifholz) and heartwood trees.

All our species of woods can therefore be grouped as follows :—

| | | | | |
|---|---|--|---|---|
| I. Heartwood coloured. Permeated with colouring matter. | { | Heartwood in living trees containing little water. | { | Pines, larches, hemlock-spruces, Douglas - firs, deodar, all <i>Cypressineae</i> and <i>Taxodineae</i> . |
| | | Trees die shortly after girdling. | | |
| | { | Heartwood in living trees containing much water. | { | Oaks, elms, ashes, lilacs, plums and cherries, mulberry-trees, sweet chestnuts, <i>Zelcova</i> and all <i>Papilionaceae</i> . |
| | | Trees may live a few years after girdling. | | |
| II. Heartwood uncoloured, so that sapwood and heartwood resemble one another. | { | Heartwood in living trees with little water. | { | Spruces, silver-firs, <i>Sciadopitys</i> , <i>Cephalotaxus</i> . |
| | | Heartwood in living trees rich in water. | | { Beeches, hornbeams, birch (except <i>Betula lenta</i>), maples, horse-chestnuts. |

The more important indigenous and foreign species of wood, shortly after felling, exhibit the following colours :

Sapwood is coloured pale whitish- or reddish-yellow in all wood-species.*

Heartwood similar to sapwood in colour.—Spruces, silver-firs, spindle-trees (*Euonymus*), horse-chestnuts, poplars, birches (except cherry-birch), *Sciadopitys*, beeches.

Heartwood only slightly darker than sapwood.—Maples, limes, *Sorbus*, Lawson's cypress, *Thuya occidentalis*.

In all succeeding woods the colour of the heartwood only is referred to :

Yellow.—Box, barberry, *Rhus*, orange-wood, pomegranate, *Maclura*, sandal, *Chamaecyparis pisifera* (Japan), elder, satin-wood (*Chloroxylon*) (Ceylon), *Xanthoxylon* (West Indies), *Ferolia* (Guiana).

Light-brown.—Oaks, *Ailanthus*, *Celtis*, *Sorbus*, hickory, sweet-chestnut, plums, elms, ash, pearwood, olive, old pencil-cedarwood.

Light reddish-brown.—Yew, larch, old mahogany, cedar (*Cedrela*), cherrywood, grenadil (*Anthyllis*, *Dalbergia*, West Indies), briarwood (*Erica arborea*), Scots pine, Cembran pine.

* [H. Stone has two species of seasoned wood (species undetermined) in which the sapwood is much darker than the heartwood. They are both from British Guiana, and their native names are **Howadanni** and **Manniballi**, "balli" being the Carib word for tree.—Tr.]

Dark reddish-brown.—*Cladrastis*, mulberrywood, some species of *Taxodium*.

Greyish-brown.—Teak, walnut-wood, jacaranda, giant thuya, swamp-cypress, *Catalpa*.

Light grey.—Woods from volcanic deposits in Japan.

Dark grey.—Some deciduous species of *Diospyros*, ironwoods* (*Sideroxylon*, *Cupania*).

Black (or black and brown).—Some evergreen *Diospyros* (ebony).

Rose-coloured.—Freshly cut pencil-cedar, rosewoods, *Chamaecyparis obtusa*, Japan, Sitka or Menzies spruce, and *Picea hondoensis* (Japan).

Yellowish-red.—*Gleditsia* (North America), *Gymnocladus* (North America), laburnum, Turkey-oak, fresh mahogany, Weymouth pine.

Cherry-red.—Sequoia, red sanders.

Bluish-red.—Amaranth-wood (purple-heart, *Copaifera*) from Guiana, black walnut, logwood, *Catalpa speciosa* (North America).

Blood-red (streaked with brown and black).—Andaman padauk (*Pterocarpus dalbergioides*).

Green.—*Laurus Chloroxylon*, cocus or green ebony † (*Brya Ebenus*), from Central America and West Indies.

Yellowish green.—Robinia.

Light olive.—Magnolia, tulipwood.

Dark olive.—*Guaiacum*, cocus (*Brya Ebenus*).

The breadth of sapwood varies in genera, species, and even in individuals; in youth all species have sapwood only; many species are when older characterized by very narrow sapwood: e.g., catalpa and sweet-chestnut with 1—2 zones of sapwood, larch 1—2 c.m. of sapwood, so some oaks, yew, mulberry, robinia; 10 c.m. and over, pines, hickory, elms, ash, etc. It should also be noted that rapidity of growth is influential on the ratio of sapwood to heartwood, in favour of the former.

* [There are many ironwoods from various countries and of various colours. The Indian kinds are chiefly *Hardwickia binata* and *Pyngado* (*Xylia dolabriformis*), dark red and dark brown in colour.—Tr.]

† [Mayr states that *Aspalathus Ebenus* is dark olive-coloured, but this species appears to be a synonym of cocus-wood (*Brya Ebenus*).—Tr.]

2. *Lustre.*

All woods can be rendered lustrous by polishing, but natural lustre renders certain woods, such as satinwood, commercially valuable. The radial section is the best for exhibiting lustre, as it shows the widest sections of the medullary rays (silver-grain), as in oaks, planes, beech, etc. The woods of the sweet-chestnut, ash and hornbeam, have no silver-grain. Maple-woods have a silky lustre on the radial section, and coniferous woods approach them in this respect. There is no lustre in the wood of any species of *Pirus*.

3. *Scent.*

Tannins, fatty oils and ethereal oils act as bearers of scent in wood; by boiling woods slowly the scents are isolated, the more rapid the boiling, the more scent comes off with the water-vapour, while by heating and drying either in the air or artificially, the exhalation of scents is favoured. But after as much of the water as possible has been evaporated, the scent still continues, until in time the wood becomes scentless. Even in old pieces of wood, by cutting and exposure of fresh parts, the typical scent is again emitted.

All species of wood possess a characteristic scent by which the genera and species may be identified, but a description of their scents can be attempted only by comparing them to well-known scents, *e.g.*, the tannin-like scent of oakwood, the turpentine scent of conifers; the varieties of scent of turpentine characteristic for different species cannot be described. Excluding conifers, the turpentine and resin of which is of commercial importance, the woods of *Lauraceae* (bay-tree) and the camphor trees (*Cinnamomum Camphora* of Japan), also *Dryobalanops Camphora*, a dipterocarp from Sumatra, are rich in agreeably-scented oil and yield commercial camphor. *Camphora glanduliferum* from Assam is also highly scented with camphor. Sandalwood oil is valuable. All wood-scents are obtainable by distillation, but usually in such small quantities as to be of no commercial importance.

Every wood loses its typical scent when it is attacked by

fungi, hence the natural scent of a wood is a proof of its soundness ; when decay sets in, the odour given off is either very disagreeable, or the opposite.

The scent of certain woods renders them commercially valuable, especially as a strong scent keeps off insects and renders the timber more durable. Pencil-cedarwood (*Juniperus virginiana*, *J. bermudiana* and *J. chinensis*), owing to its pleasant scent and fine grain, is preferred for pencils. Cedrelawood from Cuba and Central America is used for cigar-boxes on account of its fine scent and lightness. Indian sandalwood (*Santalum album*) preserves its strong, agreeable scent for years. Violet-wood (*Acacia homolophylla*, from Eastern Australia), when used for parquet-flooring, as in the castle of Herrenchiensee, emits a fine violet-scent.

Teak, olivewood, pulley-wood (*Guaiacum*), *Burcus* and *Sambucus* emit a strong odour of caoutchouc. Some woods, such as freshly cut stinkwood from South Africa (*Ocotea bullata*), have a disgusting odour. Mathey adds that of *Gustavia tetrapetala* from Guiana.

4. Hardness.

As wood is not homogeneous, it offers a resistance to its penetration by tools, that differs according to the direction of the penetrating force. Hence its hardness depends on the following :—

1. **Direction of the force.**—The greatest resistance is offered to forces acting across the wood-fibres ; the least resistance is along the fibres and also in the planes of the medullary rays, that is in the radial direction, so that wood is most easily split radially.

2. **Use of implements.**—Nails, knives, axes, saws, augers, planes, etc., act so differently that the same wood exhibits various degrees of hardness to the different implements. It is however true that hard wood is always more difficult to deal with than soft wood.

3. **The degree of wetness of the wood.**—All woods have greater tenacity and looser texture when they are wet. In hard woods, this looseness of texture is more important than the tenacity produced by wetting, so that hard woods are more,

easily worked wet than when dry. In soft woods, especially those of broadleaved trees, the wetting increases the tenacity more than the looseness of texture, so that they are easier to work dry than wet.

4. **Specific weight.**—This is a measure of the mass of wood in a given volume, so that wood of high specific weight is hard. The future discussion of specific weight therefore applies also to the hardness of wood.

5. **Parts of a tree.**—Hardness here corresponds with specific weight. The softest wood is root-wood; then the western and eastern sides of the bole; stump-wood; the upper side of the branches; the lower side of the branches, which last is the hardest wood that a tree produces. Spring-wood is always softer than summer-wood, especially when the latter is particularly broad. A more detailed account of this question will be given hereafter (p. 54).

6. **Coherence, owing to the union of the cells and of the materials that form their walls.**—Differences in coherence, in spite of a similar specific weight in the woods, cause a considerable difference in the resistance offered by them to implements.

7. **Presence of substances other than water.**—If water, which softens it, has left the cell-wall, and another material, such as resin or any impregnating substance, has replaced it, the wood becomes harder. Thus highly resinous wood, such as the knots of conifers, is extremely hard.

8. **Temperature.**—Frozen wood is much harder than unfrozen wood. The slipping aside of wedge and axe in working frozen wood cannot be explained in accordance with the prevalent theory, if, when wood is frozen, water is driven from the cell-wall.

Owing to the connection between hardness and specific weight, more detailed data will be given under the latter heading. Here the following scale of hardness is suggested :

Very hard, hard as a bone.—Pulley-wood, ebony, ironwood.

Hard.—Box, pitch-pine, hickory, barberry, hornbeam, oak, robinia, field-maple, mahogany, ash, beech, sweet-chestnut.

Fairly hard.—Walnut, pear- and apple-wood, elm, larch, yew, cherry-wood, birch.

Rather soft.—Alder, horse-chestnut.

Soft.—Pine, spruce, silver-fir, *Cedrela*, cypress, lime.

Very soft.—Weymouth pine, willow, poplar, *Paulownia*, *Cunninghamia*, *Bombax*, *Leitneria Floridana* (cork-wood from Florida, used for floats for fishing-nets).

Soft as cork.—*Herminiera*, from the Upper Nile. [Indian solah, generally termed pith, but really the wood of *Aeschynomene aspera*, which grows in marshes; it is used for hats, fishing-floats, etc.—Tr.]

5. Specific weight.

A high specific weight in wood is not necessarily a desideratum. On financial grounds, when light wood offers the same advantages as heavy wood, the lighter wood is preferred. Wood of a high sp. weight is valuable on account of the other properties that this more or less involves, chiefly hardness and caloric power. As the sp. weight $\left(\frac{W}{V}\right)$ of a piece of wood, of which V is the volume and W the weight, is very easily and exactly determined from its absolute weight and volume, for more than a century the determination of the sp. weight of woods has offered a favourite field for investigation. Nearly all investigators, from Duhamel to those of the present time, have decided that **the excellence of wood depends on its specific weight**. König, Hartig, and his scholars, Bertog, Eichhorn, Omeis and Schneider, have considered the term **heavy**, when applied to wood, as identical with **good**, from every point of view. Nördlinger, Bauschinger, Schwappach, Fernow, Roth and Janka, whose works on the strength of wood will be discussed further on, refer to excellencies dependent on high sp. weight. Other authors, such as Tetmajer and H. Mayr, regard sp. weight as only **one** of the factors in adjudging the strength of species of wood. If it were possible to exclude other factors which affect the strength of wood and often alter it in a way that does not correspond to variations in sp. weight, the latter might be the best factor in the question. But this is impossible, so that the prediction of the strength of a wood from its sp. weight is not more trustworthy than weather-forecasts based on atmospheric pressure only. Agriculture cannot be directed by the rise and

fall of the barometric column, neither can silviculture nor wood industries be based on the sp. weight of wood.

Specific weight is the ratio of the weight of a given volume of any substance to that of the same volume of water, so that, if the sp. weight of water be 100, woods with a sp. weight over 100 will sink in water, and those in which it is under 100 will float in water.

According to Sachs, the cell-walls of wood have a sp. weight of 156. Hartig * found this to be true for most woods, especially for oak, beech, birch, and spruce, and showed that there is no difference in this respect between the cell-walls of sapwood and heartwood. As in the tissues of wood there are innumerable air-bearing, closed lumina, it is evident that, in spite of the high sp. weight of the cell-wall, the sp. weight of wood is so low, that most woods float in water.

The specific weight of green wood is that of the standing or recently felled tree, but as the volume of water varies in standing trees, and water begins to evaporate from felled trees as soon as they are felled, the weight of green wood is very variable. As water ascends chiefly in the last-formed layers of sapwood, that is the wettest part of a tree and usually heavier than water, with which its lumina are full. The next outer layers of sapwood are also wetter and heavier than its inner layers.

Heartwood in a green state is always lighter than sapwood, even when, as in broadleaved trees, it is very wet. The heartwood of freshly felled conifers is always much lighter than their sapwood, for there is 35 per cent. more water in the latter. Fifty per cent. of the weight of sapwood is that of the contained water, while coniferous heartwood contains only 15 per cent. of water (by weight). The greater the proportion of heartwood there is in a tree the lighter its wood, so that the whole stem decreases in weight as it becomes older. When it is assumed that there is 45 per cent. of water in green wood, no account is taken of the above fact, nor of the variation in the wetness of the sapwood at different seasons in a year.

R. Hartig (*op. cit.*) has studied the seasonal variations of water in wood, but the results he has arrived at are not given

* R. Hartig, "Über die Verteilung der organischen Substanz des Wassers u. Luftraumes in den Bäumen." Berlin, 1882.

here, as he did not consider the influence of the weather at the time of his observations, nor the degree of moisture of the soil, individual variations, etc. H. Mayr's observations * show that the degree of wetness of the sapwood depends on the relative atmospheric humidity, which varies day and night; also on the weather, for after rain the stem may become gorged with water, and drier after a period of drought. Hence during any month the so-called maximum volume of water in a tree may be diminished; it varies also with the nature of the soil and in individual trees.

When felled stems lie in the forest with or without bark, their wetness varies according to the relative air-humidity or the raininess or dryness of the weather. Evaporation, however, on the whole, preponderates over high relative humidity or wet weather. After a stem has lain for some time in the forest, its sp. weight is that of **forest-dry** wood; this is less constant than its green weight or air-dry weight, but is always intermediate between them. In logs and firewood the upper parts approach air-dry wood in weight, those parts on the damp ground, that of green wood. Wood that is felled in winter and brought out of the forest at the beginning of spring weighs nearly as much as green wood; only split firewood shows any appreciable reduction in weight. The weight of green and forest-dry wood is of practical importance in wood-transport.

Wood becomes **air-dry**, or **seasoned**, only a long time after the felling, and the more rapidly the more the wood has been subdivided. Balks and thick planks must be kept for years and protected from rain or from resting on the ground before they become **air-dry**. Air-dry wood still contains 10—15 per cent. of its weight, in water. This is held firmly by adhesion in the cell-walls, and its mass fluctuates with the relative atmospheric humidity; hence in order to expel it artificial heating to 100—110° C. is required, at which temperature all the water passes into steam. In this way the **absolutely dry weight** of wood is determined. This weight has a scientific value only, in comparing the weights of woods

* H. Mayr, "Über den forstlichen Wert der gegenwärtig üblichen Methoden zur Bestimmung der Qualität der Hölzer." 1889.

from which that most intrusive factor water has been eliminated.

If dry or green wood is placed in water, it at once absorbs more water, till finally all the air-spaces in the wood are full. Its weight then is that of saturated wood, which has always a higher sp. weight than water (100), but lower than that of the cell-walls (156). Saturated wood always sinks, and wood that has been floated too long approaches in weight that of saturated wood. As water is a possible factor in nearly all wood industries, air-dry wood is always in demand, though it is well known that much unseasoned wood is used fraudulently. Even wood that has become seasoned after being kept for years in a dry place is a material containing a variable amount of water, for wood is hygroscopic, and its degree of wetness varies with the moisture of the atmosphere.

Air-dry wood when utilized varies in weight—

- (1) **With the relative atmospheric humidity ;**
- (2) **With the age of the tree.**

In 1861 König stated that the wood of all trees becomes lighter as they become older, and his statement has been confirmed by more recent investigations. The younger a tree and the shorter the felling rotation owing to a favourable soil and a warm locality, the heavier is the wood, but Mayr has often (*op. cit.*) remarked on the small importance attached in forestry to the sp. weight of wood.

- (3) **According to the parts of a tree.**

Roots have the lightest wood, and the wood of the upper parts of roots is lighter than that which lies below, while the thinner the roots the lighter they are. Then comes the bole, the western side of it being lighter than its eastern part. Woodmen term the eastern side of a tree its hard side, for they know this fact by experience. Wood from the crown is somewhat heavier than wood from the bole, but heavier and harder wood is on the eastern side of the stump ; branch-wood is still heavier and harder, especially on the under-side of branches.

(4) According to the breadth of the annual zones and the ratio of spring-wood to summer-wood within an annual zone.

It is well known that summer-wood is heavier than spring-wood. Foresters, builders, and manufacturers have always adjudged the hardness and weight of wood in accordance with the ratio of the amount of summer-wood to that of spring-wood. They have also considered the question of the width of the whole annual zone, which R. Hartig has recently shown to have no influence on the quality of a wood. Practical experience has decided that in broadleaved woods, the wider the annual zones, the chief increase is in the harder and heavier summer-wood, while in coniferous wood, when the zones become wider, the increase is chiefly in the spring-wood. Hence, in broadleaved woods wide zones, and in conifers narrow zones, imply heavy wood.

H. Mayr in 1884, in a pamphlet on the wood of Douglas fir, was the first to publish an account of exceptions to this law, which contrasts broadleaved and coniferous woods in such a remarkable manner. He showed that, in spite of an increase in the breadth of the annual zones, no decrease in the sp. weight of the wood followed, but that it even increased. Hartig, Cieslar, and others, proved this later for Douglas fir and other coniferous woods. It has also been demonstrated that in broadleaved woods a breadth of zone of more than 6 mm. results in a decrease in weight and hardness, and that in coniferous woods there is a similar decrease when the annual zones are less than 0.5 mm. broad. The observations also show that woods with the same breadth of annual zones are sometimes heavier and sometimes lighter. These exceptions to the law prove that another natural law exists by which the effects of the former law may be sometimes enhanced, sometimes diminished, and sometimes reversed. This natural law, enunciated by H. Mayr in 1890 ("Die Waldungen von Nord-america") owing to his own investigations and to the mass of indigenous and foreign wood then available, is as follows:

Assuming identity of soil, the specific weight and hardness of wood decreases with distance from the optimum climate

of its production both towards cooler or warmer regions. It is indifferent whether the annual zones consequently increase or decrease in breadth, or whether the wood is broadleaved or coniferous. Within the natural habitat of any species of tree the centre of its habitat produces the heaviest and hardest wood.

Every species of tree lives in a certain climatic region, although the habitat of the tree may show great irregularities owing to marine currents or topographical features. Such irregularities in the habitat of a tree, insular expansions on the one hand or insular exclusions on the other, might induce one to suppose that not the climate, but the soil, is decisive for the natural extension of the species.

[There is a close relation between a tree's demands upon temperature and upon soil. Given the proper temperature, it will grow where the soil is unfriendly; and given the most congenial soil, it will grow where the temperature is not ideal. The colder and wetter the soil, the better will a tree grow with a relatively high temperature; the drier and warmer the soil, the better it will grow with a relatively low temperature. Thus on a northern slope the forester will often find it safe to plant trees which would not thrive on the southern side of the same mountain, because northern slopes are cooler and moister than southern ones, and this difference may suffice to effect a slight reduction in the average temperature of the region. There is a wide variation among trees as to the range of temperature which they endure. But it should not be inferred that only geographical lines can be drawn for the distribution of any species. The right temperature conditions may be found outside the geographical habitat at higher or lower altitudes. A southern species, whose home is in the mountains, may find a second home in the northern latitudes of a level country, and a northern lowland species may thrive on mountains in the south.—Tr.]

Mayr's observations here (*cf.* p. 60) do not include the soil as one factor in this natural extension, but regard the range of temperature and the distribution and amount of annual rainfall as its most important factors. Hence arises the important fact for the cultivation of trees that there may be climatic regions

and climatic optima for a species even beyond its native habitat, for the possibility of the natural bridging over of localities that are unfavourable for a species is much more difficult than is generally believed. It is false to affirm that, because a species thrives outside its native habitat, it is not dependent on a decided climatic region, and that it is useless to determine climatic regions as a natural basis for the cultivation of all indigenous and exotic trees. But we must not overlook the fact that, in forestry, species can be cultivated outside their native habitat, if, although they may yield no fruit and no seed, they still produce valuable wood. In such cases, however, the species would disappear as soon as the hand of man is withheld [unless, like the English elm, they produce suckers.—Tr.].

With regard to the introduction of species of trees beyond their native habitat, for any species there are five imaginable climatic regions, three of them natural and two artificial.

- | | |
|-------------------------|--|
| | III c. Artificial region cooler than the natural habitat. |
| Natural habitat. | { II c. Region cooler than the optimum. |
| | { I. The optimum. |
| | { II w. Region warmer than the optimum. |
| | { III w. Artificial region warmer than the optimum. |

The law enunciated above may be expressed as follows: The sp. weight of every species of wood is gradually reduced from region I towards II c and II w, and towards III c and III w, whether its annual zones are wider or narrower.

The oak is the first example. Its habitat in Germany is usually II c. Only the warmest localities in Germany come under I; these are districts where there are vineyards. By experimental plantations oak is often grown in III c, while I and II w are in the south and south-east of Germany, and III w in Southern Europe. As in the first half of the rotation of all species of trees, equality of soil and sufficient moisture being presupposed, the breadth of the annual zones increases with the climatic temperature, we find a general increase in the breadth of annual zones of oakwood from

III c to II c, I, II w, and III w. What is, however, the resulting sp. weight of the wood? In II c, *e.g.*, the Spessart, the air-dry sp. weight is 50, while as we approach the warmer climate in I the annual zones become broader and the sp. weight of the wood increases, until in I an average sp. weight of 74 for air-dry oakwood is attained. This follows the old law, the wider the annual zones, the heavier the wood. If we weigh oakwood grown in II w or in III w, although actual figures are wanting, we know that the very broad-zoned wood is soft and spongy and therefore lighter in weight than wood from I.*

The larch for more than a century has been planted outside its native habitat, the Alps and Carpathians (its zones I and II w); in warmer localities, III w, and as far as Denmark and Scotland [In Scotland the climate probably approaches II w.—Tr.]. Its rapid growth in most of these countries and the great width of its annual zones, when compared with mountain larchwood, are well known, as well as the fact that its sp. weight down to 45 is much lower than in its native habitat I, where the sp. weight may be as high as 80. If we proceed upwards from the plains, the old law for conifers holds good that as the annual zones become narrower the sp. weight increases, and as they become broader the weight is reduced. But on considering the uppermost and coolest station of larch, II c, it appears that the very narrow-zoned larchwood again becomes lighter than that from I, while its sp. weight falls to 55.† There is little practical experience of larchwood from the highest regions, or it would be found opposed to the old law that conifers become heavier the narrower their annual zones.

The spruce also conforms to the new law, for its wood in the long wide regions I and II w possesses an average sp. weight of 45, whilst the broad-zoned sprucewood grown in

* [In England, the hardest and heaviest oakwood is produced in Kent, Sussex, and Hampshire, as well as in Herefordshire and its adjoining counties. These are the hottest counties in the British Isles, and presumably correspond to I for oak. The best larchwood is produced in Scotland. A study of the comparative sp. weight and of the width of the annual zones of oakwood and larchwood in different parts of the British Isles would be very useful.—Tr.]

† J. Wessely, "Die österreichischen Alpenländer u. ihre Forsten." 1853.

warmer Germany, region III w, has an average sp. weight of between 38 and 41. The region II c—the uppermost spruce region, above which (III c) its cultivation becomes impossible, as the top of II c is the upper mountain limit of tree growth—is characterised by the production of narrow-ringed “resonance” wood (used for violins and other stringed instruments), which has also a low sp. weight, as low as 40 and averaging 42.

Thus Mayr’s law explains the exceptions to the above practical laws regarding coniferous and broadleaved woods, which are no exceptions to the greater natural law that is here enunciated.

This law that the sp. weight of woods is diminished when they are produced beyond the optimum climatic region of the species of tree is especially interesting to those who maintain that the **strength of timber** is dependent on the sp. weight of wood. Schwappach (1897) is one of these, and states that the transverse strength of timber diminishes as a tree grows beyond its optimum region, which is only an assertion of this law. Hartig states, that in beechwood neither the breadth of the annual zones nor the climate exercises any influence over its sp. weight, which depends solely on the age of the tree; that in coniferous woods the sp. weight increases as long as the annual increment is increasing and diminishes when the latter decreases.

(5) **The tending of a crop of trees** must influence the sp. weight of the wood, for cleanings, thinnings, and a free position of a tree are merely alterations in the environment of trees as regards light and heat. In a dense wood dominated trees suffer from a deprivation of both light and heat. Giving a tree a free position removes it, as it were, from a cooler to a warmer climate, while for a suppressed tree these conditions are reversed. Hence, by thinning, the optimum climate for oak may be approximated to or receded from in the case of spruce. Spruce, for instance, grown in II w or III w, when suppressed has, it is well known, heavier wood, while suppressed oak grown in II c or III c has lighter wood.

(6) **The specific weight varies with genera, species, or individual trees.** As regards **genera**, woods that are produced

naturally in the warmer climates are, on the whole, heavier than those from cooler regions, *e.g.*, heavy tropical ironwoods when compared with European oakwood. However, it must not be ignored that some tropical woods are extremely low in the scale of sp. weight. The variations in the weight of woods of the same genus, but of **different species** and heat requirements, are less decided. Europe is so poor in species of the same genus of trees, as to afford few examples of this. In North America, the white oak when grown in the more southern States has an average sp. weight of 89, the black oak that of 73; the same oaks when grown in northern States have sp. weights of 77 and 70 respectively.* So far as our experience goes, however, different species of a genus that have identical heat requirements, or are cultivated in similar climatic regions, do not produce wood differing in sp. weight or in other qualities. On the contrary, it appears that nearly related species of trees, *e.g.*, Sitka and Norway spruce, Nordmann's and our own silver-fir, the white American and our sessile oak, sugar-maple and sycamore, etc., produce equally heavy wood, if grown under conditions that produce heavy wood for the genus in Europe, or equally light wood when under opposite conditions.

Attention is here directed to some common errors made in comparing exotic and indigenous plants. **Equally favourable conditions of soil and climate should be presupposed.**

Exotic conifers when introduced into European lowlands should not be compared as regards the quality of their wood with our own conifers grown in I, but with them when grown also in the lowlands. Thus Japanese larch planted in our lowlands should be compared with lowland and not mountain European larch.

As an instance of a second error, Weymouth pinewood was formerly considered the best pinewood of North America, because it afforded the longest, strongest, and most workable pinewood from the earlier settlements in the north-east of America. In Europe there are many better conifers, so that the American preference for it counts for nothing with us. The Americans have misjudged similarly the quality of the

* Census Report of the United States, 1890.

wood of other pines, which they compared with that of the Weymouth pine, such as *P. resinosa*, *P. divaricata* (*Banksiana*), *P. rigida*, *P. ponderosa*; we should not accept their judgment blindly, as it can be proved from mature Europe-grown wood only of these species, which can then be compared commercially with our own pinewood.

A third error arises from comparing the wood of young and old trees of the same indigenous or exotic species. Young conifers, *e.g.*, Weymouth pine, necessarily contain poor wood, for either they have no heartwood or very little in proportion to their sapwood, while their lower branches have not fallen, or their knots are covered with a few zones of wood only. The older the Weymouth pine is, when grown in Germany, the more favourable are the opinions held about the quality of its wood. It is this opinion, and not that of Americans, that is decisive for us.

(7) The soil under similar climatic conditions greatly affects the width of the annual zones and the weight of wood. Hartig has, however, stated that soil has no influence on beechwood, but that the best soil produces the heaviest spruce-wood.* It is certain that every species of tree finds the most favourable conditions for its growth on the best soil. It strives to form a large crown and a tall bole, so as to ensure its fructification. In forestry, however, the vegetative part of the tree, the bole, is more valuable than the fructification, and should be as free from knots, as rich in heartwood, and as cylindrical as possible. These requirements are not secured always on the absolutely best soil. Such is a well-manured garden soil, and wood grown on such a soil is branchy, broad-ringed, and may suffer from red-rot. Also on very poor, dry soil wood grows slowly, with narrow zones, and is less heavy than wood produced on moist, loamy sand or sandy loam. Hence for every species there is a soil optimum that yields the heaviest wood, climatic conditions being equal, and soils richer or poorer in nitrogen than the optimum yield wood of lower sp. weight.

(8) When sapwood passes into coloured heartwood, the

* R. Hartig, "Ban u. Gewicht des Fichtenholz." Forstliche Naturw. Zeitschrift VII. 1898.

deeper the colour, the heavier the wood. It is very difficult to decide how far the sp. weight is thus affected, as individual variations and the natural falling off in weight from the inner zones of the wood outwards complicate the question. Hartig states that the colouring matter in oakwood raises its dry weight 6 per cent. Woods, the cell-lumina of which are filled with colouring matter, such as tropical dye-woods and artificially injected wood, are considerably heavier than light-coloured wood.*

(9) **Resin** increases the weight of conifers. According to Mayr, † when sapwood passes into heartwood there is a gradual change from liquid turpentine into solid, heavy rosin. It is not true that new formations of resin occur in old wood parts. The absolute quantity of it remains constant; only its form alters; the turpentine becomes oxidised and concentrated only. The increase in weight is greatest in species that contain the most turpentine, *e.g.*, Weymouth pine, Scots pine, spruce, and, least of all, silver-fir. The stump is heaviest, not only because its wood has thick walls, but because it contains the most resin. When resin formation begins (*vide* "Defects in Wood"), and the cell-walls dry, a very remarkable increase in weight follows (resin-galls, hard knots).

(10) **Abnormal tissues** in woods usually increase their weight, but their strength is thus greatly injured. Ocluded woods, burrs or excrescences in wood, and contorted fibres are usually heavier, but not therefore better than normal wood. Among these may be reckoned the abnormally hard wood which all our conifers produce on the lower side of branches, at bends in the stem, on the rootstock, and on the eastern side of stems, that woodmen name hard, or red, wood (*cf.* "Defects in Wood").

(11) **Organic and inorganic salts**, that are partly soluble in water, contribute appreciably in the formation of sapwood. Such are sugar, albumen, gums, etc. In heartwood they have no sensible influence on the weight of wood. Floating wood

* [The black wood of ebony weighs 75—80 lbs., and its sapwood only 49—50 lbs., per cubic foot, the extra weight being due to a coloured substance that fills the lumina till the structure is scarcely discernible by a microscope.—Tr.]

† H. Mayr, "Das Holz der Nadelhölzer." 1894.

in rivers involves a partial absorption of these salts from the sapwood by the water, so that the weight of the wood is reduced. Wood-merchants say that this loss is slight, but detailed investigation is wanting. It is evident that injection with preservative substances must increase the weight of wood.

Still less investigated is the share of ash-constituents in the weight of wood, but at any rate it is inconsiderable. In broadleaved and coniferous wood, as soon as the annual zone is completed, there is no further addition of ash-constituents.* In palms and bamboos, the wood of which is intermediate to exogenous wood and bark, there is a change in the mineral constituents during the whole life of the stem. Thus the quantity of silica steadily increases, so that the sp. weight is considerably increased. According to Koide, the sp. weight of the Hachiku bamboo (*Phyllostachys puberula*) is in the first year 109, in the fifth year 113, in the eighth 118, but after the eighth year it steadily diminishes with the age of the bamboo. This law is true for all bamboos.†

A knowledge of the sp. weights of forest-dry wood is of practical importance as regards transport from forests. It is, however, very variable. Böhmerle and Vultejus have determined these weights as follows in kilograms per cubic meter, solid or stacked, and they are also given in pounds avoirdupois per cubic foot.

OAK, BEECH,¹ HORNBEAM,² ASH, SYCAMORE, ELM.

The weights of beech and hornbeam cordwood are given in the second column in metric and English weights and measures.

| | | | Kilos. | | Lbs. |
|-----------------------|----------------|-------|--------|-----|---|
| (Cubic meter) | Logs | ... | 720 | ... | 45.3 per cubic foot. |
| (Stacked cubic meter) | Split cordwood | ... | 670 | ... | 840 ¹ ... 42...53 ¹ " |
| " | " | Round | 600 | ... | 820 ² ... 38...50.5 ² " |
| " | " | Stump | 614 | ... | 38.5 " |
| 100 faggots | ... | ... | 1,200 | ... | 75.5 per 100. " |

* [Masses of opaline silica termed *tabashir* are sometimes formed in the hollows of bamboos, while the vessels of *Acacia Catechu* and of teak may be filled with calcium carbonate and calcium phosphate or silica. In *A. Catechu* this property renders the wood better for catch-making.—Tr.]

† [This fact has long been known in India, where bamboos have a considerable commercial value. The culms up to a certain age vary in external colour and increase in weight; only the heavier ones are used for building purposes, while after attaining a maximum density they gradually rot. Their age is known by the colour of their rind.—Tr.]

BIRCH, ASPEN, SPRUCE, SCOTS PINE, SILVER-FIR, LARCH,
BLACK PINE.

The weights of silver-fir and black pine cordwood are given in the second column :

| | | <i>Kilos.</i> | <i>Lbs.</i> | |
|-----------------------|----------------|-----------------|-------------|-----------------|
| (Cubic meter) | Logs | 570 ... | 36 | per cubic foot. |
| (Stacked cubic meter) | Split cordwood | 470 ... 660 ... | 29.5...41.5 | „ |
| „ | „ Round „ | 470 ... 780 ... | 29.5...49 | „ |
| „ | „ Stump „ | 350 ... | 22 | „ |

These weights, according to Baur,* are as follows for stacked wood :

| | SPLIT CORDWOOD. | | ROUND CORDWOOD. | |
|----------------------|--|---|--|---|
| | <i>Kilos.</i> <i>per cubic</i> <i>meter.</i> | <i>Lbs.</i> <i>per cubic</i> <i>foot.</i> | <i>Kilos.</i> <i>per cubic</i> <i>meter.</i> | <i>Lbs.</i> <i>per cubic</i> <i>foot.</i> |
| Spruce | 343 | 21.5 | 411 | 26 |
| Scots pine... .. | 387 | 24 | 424 | 27 |
| Larch | — | — | 480 | 30 |
| Silver-fir | — | — | 362 | 22.5 |
| Weymouth pine | — | — | 263 | 16.5 |
| Oak | 635 | 40 | 573 | 36 |
| Beech | 565 | 35 | 436 | 28 |
| Hornbeam | — | — | 587 | 37 |
| Alder | 436 | 28 | 380 | 24 |
| Aspen | 428 | 27 | 380 | 24 |
| Robinia | — | — | 570 | 36 |
| Ash | 587 | 37 | — | — |
| Sycamore... .. | 577 | 36 | — | — |

In Germany, for taxation purposes, one solid cubic meter of wood is reckoned at 600 kilos. (a cubic meter = 35.1 cubic feet, and 1 kilo. = 2.2 lbs.). In German railway-transport a cubic meter of hardwood is considered to weigh 1,000 kilos. and of softwood, 750 kilos.

The following list of the air-dry and forest-dry sp. weights of wood has been prepared from data supplied by Nördlinger, Chevandier, v. Baur, Bühler, Karmarch, v. Exner, v. Seckendorf, Möller, Hartig, Mohr, Sargent, Fernow, Schwappach, as well as by the authors of the present book. It is well known that good average figures may differ from the actual weights when the maximum and minimum weights of the same species also differ considerably; this is especially the case in forest-dry wood, where incorrectness depends more on the amount of sapwood and heartwood in the specimen than on the water it

* Fr. v. Baur, "Über Gewicht, Volumen u. Wassergehalt des Holzes."

contains. Maximum weights of forest-dry wood imply chiefly sapwood, while minimum weights occur when the specimen is chiefly heartwood. Hence the maximum forest-dry weights of all species of wood vary between 100 and 130, and their minimum forest-dry weights between 40 and 100. In air-dry weights, the disturbing factor, water, if not excluded entirely, is kept so far in the background that sapwood and heartwood contain equal volumes of water. In air-dry wood, therefore, the average figures given are very approximately correct, the highest sp. weights of the same species varying between 55 and 95, and the lowest between 35 and 80.

The woods are grouped according to their average air-dry weights, those with sp. weight of 80 and over being classed as very heavy, from 70 to 80 as heavy, from 55 to 70 as moderately heavy, from 40 to 55 as light, and those under 40 as very light. Wherever this can be done with any precision the sp. weight of forest-dry wood is also given. The weight of a cubic meter of the wood or of a stacked cubic meter (*Raummeter* or *stere*) can be calculated by multiplying the figures by 10 or 7.7 respectively. [As a cubic foot of water weighs 1,000 oz. = 62½ lbs., the weight of a solid cubic foot of wood may be calculated from its sp. weight by multiplying it by .625, and for a stacked cubic foot by .471. American board-measure is in square feet of one-inch planking, and is thus twelve times its volume in cubic feet.—Tr.]

TABLE OF SPECIFIC WEIGHTS OF WOOD.

| | <i>Air-</i> <i>dry.</i> | <i>Forest-</i> <i>dry.</i> | | <i>Air-</i> <i>dry.</i> | <i>Forest-</i> <i>dry.</i> |
|------------------------------------|----------------------------|-------------------------------|---|----------------------------|-------------------------------|
| Cocus and violetwood | 140 | — | Yew | 80 | 103 |
| Guaiacum | 130 | — | Zelkova Keaki | 76 | 106 |
| Ebony | 120 | — | Pedunculate oak | 76 | 104 |
| Ironwoods, various | 115 | — | Pitch pine (<i>P. palustris</i>) | 75 | — |
| Evergreen oaks | 110 | — | Hickory, German (<i>Hicoria</i> <i>alba</i>) | 75 | Sap- |
| Grenadil | 100 | — | | 82 | wood |
| Satinwood | 100 | — | | | Heart- |
| Boxwood | 95 | — | | | wood |
| Briarwood (<i>Brica arborea</i>) | 95 | — | White oak | 75 | — |
| Rosewood (<i>Jacaranda</i>) | 90 | — | Robinia | 75 | 100 |
| Turkey oak | 85 | 110 | Ash, European | 74 | — |
| Hickory, American | 84 | — | Sessile oak | 74 | 101 |
| Whitethorn | 82 | — | Gleditsia | 73 | — |
| Hornbeam | 80 | 105 | Beech | 72 | 100 |
| Teak | 80 | — | Walnut (<i>J. regia</i>) | 72 | — |
| Mahogany | 80 | — | Elm | 70 | 100 |
| Bamboo (<i>Phyllostachys</i>) | 80 | 113 | Field-maple | 70 | 90 |

TABLE OF SPECIFIC WEIGHTS OF WOOD—*continued.*

| | <i>Air- Forest- dry. dry.</i> | | | <i>Air- Forest- dry. dry.</i> | |
|-------------------------------------|-----------------------------------|-----|---------------------------------|-----------------------------------|----|
| Pear | 70 | 105 | Pinus rigida | 51 | — |
| Cladrastis... .. | 67 | — | Pencil-cedar | 50 | — |
| Apple-tree | 67 | 101 | Do. (Sargent) | 33 | — |
| Austrian pine | 67 | — | Spruce | 47 | 80 |
| Sycamore... .. | 66 | 93 | Sitka spruce | 47 | — |
| Fraxinus alba | 65 | — | Silver-fir (European) | 46 | 97 |
| Sweet chestnut | 65 | 100 | Lawson's cypress | 46 | — |
| Sugar-maple | 65 | — | Willow (<i>S. alba</i>)... .. | 46 | 78 |
| Red oak (<i>Q. rubra</i>) | 64 | — | Hemlock spruce | 46 | — |
| Cherry | 64 | 93 | Swamp cypress | 45 | — |
| Corsican pine | 62 | — | Aspen | 45 | — |
| Hazel | 62 | — | White poplar | 44 | — |
| Elm (<i>E. effusa</i>) | 62 | 91 | Cembran pine | 44 | — |
| Larch | 60 | 81 | Pyramidal poplar | 42 | — |
| Juniper (common) | 60 | — | Picea pungens | 42 | — |
| Black walnut | 60 | — | Redwood (California) | 42 | 88 |
| Birch | 60 | 96 | Cryptomeria japonica | 42 | — |
| Plane | 58 | — | Catalpa speciosa | 42 | — |
| Horse-chestnut | 57 | 90 | Grey walnut | 41 | — |
| Douglas fir (Am. and German) | 57 | — | Abies concolor | 41 | — |
| Magnolia hypoleuca | 55 | 80 | Chamæcyparis obtusa | 41 | 83 |
| Sallow | 53 | 85 | Weymouth pine | 40 | 75 |
| Pinus divaricata | 53 | — | Engelman's spruce | 38 | — |
| Scots pine | 52 | 82 | Sequoia gigantea | 34 | — |
| Acer dasycarpum | 52 | — | Paulownia | 25 | — |
| Lime | 52 | 80 | Cunninghamia | 20 | — |
| Alder | 52 | 83 | Cork (<i>Q. Suber</i>) | 15 | — |
| | | | Herminiera | 15 | — |

According to Mayr's observations, Weymouth pinewood weighs the same in Europe as in America, and P. Roth's figures quoted in "The White Pine," by V. M. Spalding, 1899, concur.

6. Coherence.

Coherence is the force that keeps the constituents of wood united; it is measured by the resistance offered by wood to shearing strains and to a separation of the cells, tissues, or annual zones. Tetmajer states that the coherence of wood may be measured by the amount of deformation exhibited in testing its strength and by the force applied. Its influence is here apparently greater than that of specific weight, to which coherence is not proportional. Whenever wood is utilized its coherence comes into play, but there are no exact observations of this quality in woods of different species.

7. *Hygroscopicity.*

The hygroscopicity of a wood is its reaction to water and water-vapour. If absolutely dry wood is placed in contact with air saturated with water-vapour, as an organised body, the walls of its tissues gradually absorb so much moisture that the wood becomes saturated. The weight of the woody tissue is then about 15 per cent. more than its absolutely dry weight. If the wood is in air with a relative humidity of 50, it absorbs gradually only 50 per cent. of the water that it could absorb in saturated air, viz., about 7 to 8 per cent. of its own weight. **The absorption of the walls of woody tissue is therefore proportional to the relative humidity of air,** allowing a sufficient time for the action of the atmospheric moisture. Water can be deposited only in drops in the cell-lumina, which are completely surrounded by ligneous walls, if the temperature of the air inside the cells is cooled down almost to the dew-point owing to the cooling of the external air; as the temperature rises, water disappears again from the lumina. The water, which persists in the wood for some time at least, at all temperatures, is either the remains of the original water in the growing tree or has entered the wood after contact with water, so that the air from the cell-lumina is gradually replaced by water and the wood then becomes saturated.

In wood-industries, the importance of the saturation of wood by water is not due to any consequent increase in weight, but because wet wood is more accessible to fungi; also because in many other technical qualities, such as transverse or strength and combustibility, it becomes deteriorated and that its shape alters as its contained moisture varies. The consequent increase in volume of wet wood is termed **swelling**, while a decrease in volume of drying wood is termed **shrinking**, both these actions being included in the word **warping**. Shrinking is often accompanied by **cracks**, which cause further deterioration in the quality of the wood.

As already stated, absolutely dry wood may absorb water from saturated air till it has increased 15 per cent. in weight, when the cell-walls are saturated. The expansion in volume

is, however, not thus completed. It has been shown by observations, including those of Mayr, that when wood remains lying for a long time in water a still further expansion results, until the wood is completely saturated. If we term the volume of wood the cell-walls of which are saturated with water, such as the sapwood and heartwood of a freshly-felled tree, the volume of green wood, then this increased volume may be described as the **saturated volume**.

Wood-tissue for some time in contact with air with a relative humidity of 50 per cent. swells up to a condition which is half the swelling resulting from contact with saturated air (relative humidity 100). However variable the absolute amount

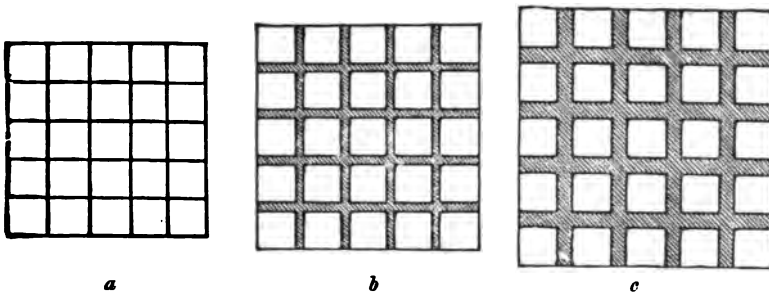

Fig. 29.

a Section of the cell-walls in wood absolutely dry, formed of mycellæ without intermediate spaces. *b* The same, in air with relative humidity 50, the intermediate spaces between the mycellæ filled with water. *c* The same in saturated air, or as green wood, saturated with water.

of swelling may be in different species of wood, in all woods the amount of swelling or shrinking is proportional to the increase or decrease in the relative atmospheric humidity.

The best and most natural way to understand the processes of swelling and shrinking is to consider the cell-wall as composed of mycellæ; when it is absolutely dry, adjoining mycellæ, which though invisible must have a prismatic or cubical shape, have no spaces between them (Fig. 29 *a*).

If such a piece of cell-wall should come in contact with moist air or with water, the water forces its way between the mycellæ, forming interstices, until the wall swells so as to correspond to its saturated volume. Fig. 29*b* shows this saturation up to 50 per cent., 29 *c*., with saturated air. The

shrinking of drying wood shows the reverse process, as the water of inhibition gradually leaves the cell-wall.

If wood were thoroughly homogeneous, as is a wedge of clay or cement, it would stretch or contract equally on all sides; as it is composed of elongated organs, which alter their shape much less along their longer axis than radially or tangentially, the alteration in the whole piece of wood is unequal in different directions. It has been proved that in passing from its green volume to its air-dry volume the length of a wooden rod shrinks on the average by 0·1 per cent. of its original length,

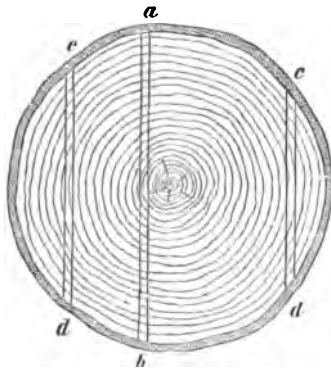

Fig. 30.

a—b Plank from the centre of the stem with a section nearly radial. *c—d* Planks with more or less tangential sections, which shrink and warp more than *a b*.

whilst in the radial direction, along the medullary rays, the shrinking is from 3 to 5 per cent., and in the tangential direction, tangential to those of the annual rings, 6 to 15 per cent. The greater contraction along the tangents may be studied on any freshly cut piece of wood, as it causes the wood to crack perpendicularly to the direction of shrinking, that is radially. The effect of unequal shrinking is specially noticeable in planks; the more tangentially they are cut the more they contract in width, but the nearer the sections are to the

radius of the stem, the less the shrinkage (Fig. 30).

The fact that, in spite of the saturation of cell-walls with water, if the amount of water in the cell-lumina be reduced there is a shrinkage in the walls of wood-tissue, is true also for standing trees. Kaiser and Friedrich, by measuring trees in daytime at the moment of greatest transpiration and at night when transpiration is arrested and the tissues are gorged with water, have shown that their diameters vary in width. Mayr's observations also show that the length of a tree fluctuates with its water-contents.

The amount of shrinkage depends on : 1. The water-con-

tents at the beginning and end of the drying. As regards the former, sapwood contains more water at daybreak after a period of rainy weather, than at sunset, after dry weather. This variation continues throughout the year, and is not confined to any season; felling in summer or winter, therefore, alters the degree of wetness of wood and the consequent shrinkage only according to the weather that prevails at the time of felling. It is therefore indifferent as regards the sapwood whether wood is felled in dry weather during either summer or winter. Only the fact that a certain season is drier than another could render it more favourable for felling trees.

The amount of shrinkage in green wood is the greater the more the wood dries; it is greater from green wood to air-dry wood than from air-dry wood to wood that is absolutely dry.

2. A wood that is air-dry does not, therefore, cease to warp, but its volume still varies with the relative humidity of the air. This fact is of great technical importance, for wooden objects made in the moister climatic regions, such as the British Isles, or Japan, when imported into drier countries invariably warp and may become completely useless. It is only when they are prevented from drying, or becoming moist, under the opposite conditions of import from drier countries, that they do not warp. If they are lacquered or varnished they will not warp. Similar results follow for all wooden objects that have been made in wet weather (window-fittings, picture-frames, tables, flooring, etc.).

3. As heartwood is always drier than sapwood, it shrinks less. Heartwood of conifers contains less water than that of broadleaved trees, so is more serviceable when it is necessary to use wood that has been recently felled.

4. The heavier a wood, the more it shrinks when dried.* R. Hartig† found that the hardest and heaviest coniferous wood, at bends in the stems of trees that he and Cieslar termed "redwood," shrinks less than normal wood. The following law, as stated by Nördlinger, is, however, correct: Branchwood shrinks more than stemwood, the latter more

* "Nördlinger," 1886. R. Hess, 1887.

† R. Hartig, "Holzuntersuchungen, Altes u. Neues." 1901.

than rootwood, uncoloured heartwood more than the outer layers.

This reaction of sapwood and heartwood in spruce, silver-fir, birch, beech and hornbeam, which have no normal colouring matter in their heartwood, is not contrary to 1, where sapwood is said to shrink more than heartwood. It is truly a case of the amount of shrinkage, after sapwood and heartwood have attained a similar degree of moisture, namely their air-dry volume.

5. When heartwood is coloured, as in oak, larch, pines, etc., it shrinks more than the sapwood; in robinia (Hartig) by 8 per cent., in larch by 10 per cent.

6. The contents of a wood in resin affects its shrinkage, for in coniferous woods resin can penetrate the cell-walls only after they have parted with their water. Hence only after a tree has been felled can the reduction of warping, owing to a deposit of rosin, be noted. The more slowly coniferous wood is dried (Mayr) the greater the accumulation of hard rosin and the less the wood will warp. Species of wood that are naturally very resinous, therefore, shrink less than less resinous woods. Hence the wood of Weymouth pine (in opposition to the law of greater shrinkage in heavier woods) shrinks less than Scots pinewood, the latter less than spruce, and that less than silver-fir. Pitch-pine shrinks less than Weymouth pine or Scots pine, and hence the preference given to pitch-pinewood.

7. The washing-out of soluble salts by placing wood in water, according to Nördlinger, has no influence, and (D. Bersch) only a slight influence on the shrinkage (in floating and rafting).

8. The unequal changes in wood due to drying and wetting result not only in an alteration in its volume, but also in warping (withdrawal of a piece of wood from its original planes).

| Woods. | Percentage of Shrinkage. | | |
|----------------|--------------------------|---------|-------------|
| | Longitudinal. | Radial. | Tangential. |
| Oak | 0·3 | 4·3 | 6·5 |
| Ash | 0·5 | 4·6 | 7·2 |
| Beech | 0·3 | 5·0 | 9·3 |
| Hornbeam | 0·8 | 5·6 | 10·5 |

| Woods—continued. | Percentage of Shrinkage. | | |
|-------------------------------------|--------------------------|------------------|-------------|
| | Longitudinal. | Radial. | Tangential. |
| Pear..... | 0.3 | 3.2 | 9.1 |
| Sycamore | 0.1 | 3.2 | 6.0 |
| Birch | 0.5 | 4.5 | 6.5 |
| Spruce..... | 0.08 | 2.0 _i | 4.5 |
| Silver-fir | 0.10 | 3.3 | 6.1 |
| Scots pine | 0.10 | 2.2 | 4.4 |
| Larch | 0.15 | 3.3 | 4.2 |
| Robinia | 0.13 | 3.9 | 5.8 |
| Mahogany | 0.11 | 1.1 | 1.8 |
| Upper side of spruce branches | 0.09 | | |
| Lower " " " | 1.29 | | |

The next statement gives the shrinkage in total volume in passing from green to air-dry wood in percentage of the volume of the green wood. The figures in brackets (Weisbach) refer to the increase in volume of air-dry wood that has been placed in water for the space of a month.

| Shrinkage. | | |
|----------------------------|--------------------------|------------------------|
| Slight. | Moderate. | Large. |
| Mahogany 1.4 — | Robinia 5.0 — | Lime 7.0 (11.3) |
| Weymouth pine 2.5 — | Sycamore 5.0 (8.5) | Beech 7.2 (10.6) |
| Ebony 3.1 — | Birch 5.5 (7.9) | Cherry ... 7.3 (9.4) |
| Larch 3.3 — | Ash 5.7 (7.5) | Hornbeam 7.5 (12.9) |
| Scots pine 3.5 (4.8) | Pear 5.8 (8.6) | |
| Spruce 4.0 (6.5) | Alder 5.8 (6.3) | |
| Elm 4.2 (9.7) | Apple..... 5.9 (10.9) | |
| Silver-fir 4.6 (5.4) | Oak..... 6.0 (6.7) | |
| Poplar 4.6 (6.2) | Walnut 6.0 — | |
| | Horse-chestnut 6.0 — | |
| | Norway maple. 6.5 — | |

[The percentages in the last tabular statement show how to calculate the reduction in volume, *e.g.*, of railway-sleepers, from the green volume of the wood to its volume when utilizable in an air-dry condition. This is very useful for sleepers of somewhat doubtful dimensions, that would shrink to perhaps a smaller size than that agreed to by a railway company, and might consequently be rejected.* The figures in brackets are useful when timber is floated, as it

* Mathey *ou cit.*

shows that Scots pine, which is more resinous than spruce or silver-fir, absorbs less water than either, and is therefore less liable to saturation than they are. Such resinous wood, *e.g.*, of pines, larch, or deodar, will float longer and is less liable to sink than the wood of spruce, or silver-fir.

Boppe's "Technologie Forestière" and Mathey's "Exploitation Commerciale des Bois" give some practical results about warping which are not given by Gayer, and form the subject of the next section.

8. Practical Results of Warping.

Dubamel de Monceau split some scantlings and poles by two or three cuts in order to show longitudinal shrinkage, and as seen in Fig. 31, each split piece curves outwards.

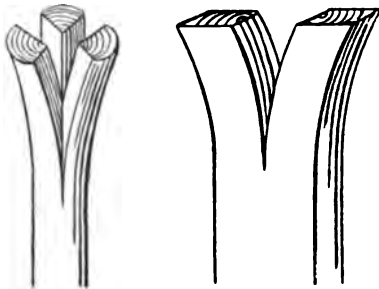

Fig. 31. (After Boppe.)

This explains why planks sawn through the centre of a log (Fig. 32) generally crack, the crack being the deeper, the thicker the plank, the more sapwood it contains and the wider the annual zones of wood.

The outer zones contract more than the central ones, and the central plank (Fig. 33) is curved convexly on both its larger surfaces. If planks are cut at distances more and more removed from the centre of the wood, they tend, owing to unequal warping, to become more and more concave on their outer surfaces, as shown in Fig. 34.

The shrinkage in width of such planks has been referred to already (p. 68). If a floor be made with insufficiently dried planks, they leave spaces between them on drying, while if the planks are nailed on the joists of the floor with their inner sides exposed to the air, they tend to shell-out. In good flooring, planks are dovetailed into one another to render the floor airtight.

The centre of any log containing the pith, being frequently knotty in coniferous wood and in broadleaved wood often

deviating from the vertical direction, is usually defective, so that the best planks and other scantling are obtained by rejecting the central plank and cutting the log into two or four balks (Figs. 35 and 36), which can each be sawn up into suitable pieces. This obviously requires logs of somewhat large



Fig. 32. (After Boppé.)



Fig. 33. (After Boppé.)

diameter, but yields timber that is much superior in quality to that produced when smaller logs are merely sawn through in one direction. Duhamel showed that by thus cutting a log into four pieces, danger from cracks and warping is much diminished. In Fig. 34 it is seen that the shrinkage of the four planks into which the wood is thus divided is quite uniform, and chiefly at their outer ends.

In India, where boxwood is cut into round pieces for export, each piece is sawn down to the centre along a radius, and this prevents any other cracks, the large opening widening or narrowing according to the degree of moisture of the air. This is also the practice in Japan (Fig. 37).

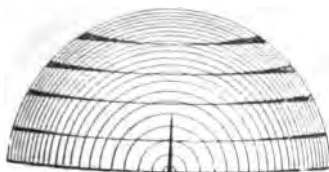

Fig. 34. (After Boppé.)

In younger trees (Fig. 37) the concentric zones are fairly uniform from the pith to the bark, while in older trees the larger zones are shown in the middle of the transverse section (Fig. 38). Hence the former usually crack in one place, down to the radius, while in older logs there are several internal cracks.

When, as in railway-sleepers, a fairly thick plank is cut

out of the centre of a tree, it can be prevented from cracking by driving in an S-shaped thin steel clamp, which holds the wood together.

The various methods of seasoning wood, injecting it with

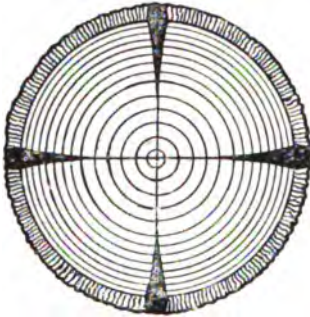

Fig. 35. (After Boppe.)

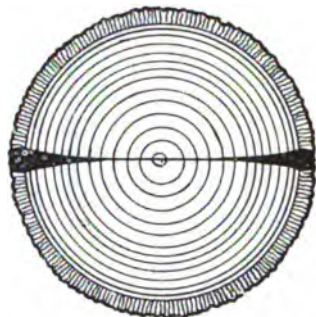

Fig. 36. (After Boppe.)

preservative materials and otherwise improving its quality, are dealt with in a subsequent chapter (p. 502).

Whilst in most of the industrial uses of wood rapid withdrawal of water is required, there are some in which wood should be rendered as watertight as possible. This is specially

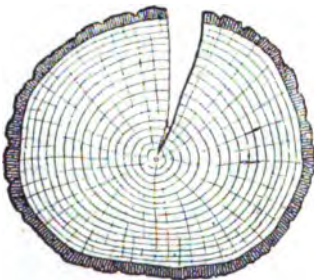

Fig. 37. (After Boppe.)

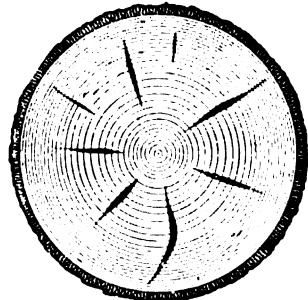

Fig. 38. (After Boppe.)

the case with staves for casks to contain liquids, that should part with as little of their contents as possible. The direction perpendicular to the medullary rays is that through which liquids pass least freely. Oak staves are split along the radius of the stem, and the medullary rays are parallel to their longer surfaces, so that they are very impervious to liquids contained in the casks. Beechwood is very permeable,

and therefore useless for casks, except those containing butter and other more or less solid substances. In split oak or chestnut palings, the fibres and vessels are not cut, and they are therefore much less permeable by water than sawn palings.—Tr.]

9. Effects of Heat on Wood.

(a) Change of Shape.

The coefficient of linear expansion of a rod is the increase in its length for 1° C. divided by its original length. Thus, if a rod one meter long, at 0° C., receives an increased temperature of 100° and thereby expands 1 mm. in length, its coefficient of expansion would be $\frac{1}{100000}$, or 0·0001. It should be noted that for wood, this expansion longitudinally is only a fraction of its radial expansion, and that the former is less than in metals or glass, which being homogeneous, expand equally in all directions.

| Material. | Co-efficient of Expansion. | | Ratio $\frac{R}{L}$. |
|--------------|----------------------------|------------------|-----------------------|
| | Radial. R | Longitudinal. L. | |
| Boxwood . | 0·0000614 | 0·00000237 | 25 : 1 |
| Silver-fir . | 0·0000584 | 0·00000371 | 16 : 1 |
| Oak . . | 0·0000544 | 0·00000492 | 11 : 1 |
| Spruce . . | 0·0000341 | 0·00000411 | 6 : 1 |
| Iron . . | | 0·00002850 | Iron Spruce 7 : 1 |
| Glass . . | | 0·00000860 | Iron Oak 6 : 1 |

[Where iron girders are used in buildings, in case of the house being burned, the expansion of the girders tends to knock down the walls ; this is not the case with wooden beams.—Tr.]

In order to determine exactly the effects of heat on wood, the wood and the air in which it is placed must be absolutely dry. If this is not the case, as in the wood of a living tree or of one recently felled, or in converted wood, heat always produces contraction. This is because the heating of the contained water not only counteracts the expansion due to heat, but produces even a reduction in volume.

Frozen wood, according to Mayr, is affected by heat quite

differently from unfrozen wood, and this proves that water does not exude from the cell-walls of frozen wood. On the contrary, owing to the retention of water by these walls, a reduction of temperature acts oppositely on frozen and unfrozen wood. When the temperature is reduced the latter absorbs water from the air and expands, while frozen wood contracts; if the temperature is reduced considerably below freezing-point, frozen wood cracks, as does a mass of ice under similar conditions. Hence, when the air-temperature is very low, frostracks occur in living trees, but they must not be explained by differences of temperature in the internal and external zones of wood in the tree, phenomena which Mayr states do not occur in nature.* Greenwood when heated above 0° C. follows the laws of evaporation of water, but when cooled below 0° , it follows the laws for reduced temperature in solids.

(b) *Movements of the Water in Wood.*

When wood is heated not only the temperature of the substance of the wood is raised, but also that of the air and water it contains. If freshly felled wood or wood saturated with water from lying in it is suddenly heated, much water exudes on to the exposed surfaces of the wood; if then the temperature be reduced the exudation of water ceases, but if the wood be submerged, it absorbs still more water. The water

* [*Internal heat of trees.*—A remarkable series of experiments, with a view to ascertaining the variations of temperature in trees, has been conducted by Herr F. Schleichert, of Jena, who publishes the results in the *Naturwissenschaftliche Wochenschrift*.

Herr Schleichert finds that the general temperature of the interior of trees is dependent upon the temperature of the surrounding air, but is influenced also by other causes, such as the ground temperature, the temperature of the water ascending in the wood, and the temperature of the branches, which are directly heated by the sun's rays.

The mode of experiment was the following: A hole was bored in the stem of a tree on the north side at a height of $1\frac{1}{2}$ metres (nearly 5 ft.) from the ground. In the hole was placed to a depth of 12 centimetres (nearly 5 in.) a thermometer, and sealed up with wax. A second thermometer similar to the first was fastened to a branch of the tree, so that the air circulated freely round it.

The temperatures registered by the two instruments were taken at varying intervals during the day and compared.

The readings of the thermometers for eight days in June, which are published, bring to light a curious phenomenon. While the external temperature showed the usual maxima in the afternoon, the maxima in the interior of the tree were recorded at midnight and the minima at midday. Tr.]

exudes owing to the expansion of the sap and air contained in the wood, the expansion of the woody substance scarcely intervenes. The heating and cooling of the included water and air also proceeds in living trees, where it is an important factor in the ascent and descent of water, as well as in the lateral passage of water into the medullary rays.

This movement of water proceeds also in converted wood, if it is insufficiently dried. The water is then driven outwards by the expanding air, along its natural paths towards the external surfaces of the wood, that therefore become wet. The practical effects of this is to favour dry-rot (*Merulius lacrimans*), on joists and planks.

(c) *Decomposition of Wood.*

If wood is heated up to 100° C. it first loses all its water and becomes absolutely dry; several observations have proved that the other properties of wood are thus somewhat altered. The production of absolutely dry wood is of importance in many experiments, which can be carried out only when the disturbing factor, water, is eliminated. If the wood is heated still further, gases are produced and ignite when in contact with a flame, until finally only ashes remain; the rest of the wood passes into the air in the form of water-vapour and carbon-dioxide, with a small amount of ammonia.

If air be excluded or admitted insufficiently during the heating of wood, the woody tissue is decomposed :

- From 150° to 280° into water-vapour, acetic acid, formic acid, methyl alcohol, with a brown residue.
- „ 280° to 360° into carbon-dioxide, air monoxide, marsh-gas, acetyl, ethyl, and a brown residue.
- „ 360° to 430° into marsh-gas and hydrogen, and a thick brown liquid of paraffin, benzol, carbolic acid, with charcoal as a residue.
- „ 430° to 1,500° wood yields the same products as before (360° to 430°), no new ones being formed.

As regards so-called **unflammable wood**, it is injected with several chemical compounds, chiefly salts of alum, and becomes difficult to kindle, but is still inflammable after being subjected to fire for some time.

10. *Conductivity of Wood.*

(a) *Heat.*

Wood is one of the worst conductors of heat and is therefore largely used for matches, and for handles of tools that are subjected to various temperatures. Wood conducts heat better longitudinally than transversely, in the ratio of 18 : 10 for softwoods and 13 : 10 for hardwoods. Heavy hardwoods conduct heat better than softwoods, and wet wood better than dry wood, as water is a better conductor of heat than wood.

(b) *Electricity.*

Wood is also a poor conductor of electricity and serves as an insulator; high specific weight and wetness reduce its resistance to the passage of electric currents. This is the reason why living trees are struck by lightning more frequently than dry trees; also isolated trees, on account of the large amount of water they contain, their high specific weight, and the spread of their crowns, than trees growing in dense crops. Also certain species such as oak, in preference, as is generally asserted, to beech. The latest investigations of Hartig, unfortunately interrupted by his too early death, tend to show that the immunity to lightning stroke assigned to beech is not warranted. Hartig states that beech is just as often struck as oak, but the external and internal action of lightning on beech and oak differ. The fact stated by Janescu, that oily trees (*e.g.*, beech, walnut, birch and lime) when compared with starchy trees (oak, poplars, ash, elm) are worse conductors and less frequently struck than the latter, should be noted. [Resinous conifers, such as Scots pine, are rich in oil during winter, but poor in oil in summer. Oil is a bad conductor of electricity.—Tr.]

(c) *Sound.*

Wood conducts sound well along its fibres, *i.e.*, longitudinally; the slightest noise at one end of a log can be

heard distinctly at the other end. Dry wood conducts sound better than wet wood. The conduction of sound is interrupted or the sound deadened by decay in the centre of the tree, so that the healthy or diseased condition of the wood of a felled tree may be thus tested.

(d) *Light.*

Wood only in very thin sections is permeable by light; then, like calc-spar, it exhibits double refraction. Wood is very permeable by Röntgen rays.

C. CHEMICAL PROPERTIES OF WOOD.

The ultimate analysis of woods varies within narrow limits; its organic substance when dry is composed of the following elements: Carbon, 50, hydrogen, 6, oxygen, 43·7, nitrogen, 0·3, half its volume being carbon.

The chief constituents of wood are cellulose ($C_6H_{10}O_5$) and lignin ($C_{26}H_{30}O_{72}$). Cellulose is therefore a carbohydrate resembling sugar in its composition. Lignin is the most highly carbonised constituent of the cell-wall. Lignin is also known as woody substance; as the lignifying substance of cellulose; with other materials in paper-manufacture, as the encrusting substance. Lignin is not a homogeneous substance, but according to Payen a mixture of four others with different reactions to alcohol and ether. Pure cellulose is dissolved entirely by concentrated sulphuric acid and converted into dextrin and fermentable sugar. Treated with ammoniacal oxide of copper, cellulose is dissolved completely, but can be precipitated again by the addition of acids, saline and sugar solutions and gums, as a white, structureless mass.* When cellulose is treated with HNO_3 nitro-cellulose is obtained, a highly explosive compound (gun-cotton, pyroxylin), very soluble in alcohol or ether, and when the solvents are evaporated the precipitate is collodium, colourless and without any structure.

ANALYSIS BY WEIGHT.

| | Cellulose. | Lignin. | Mean for Wood. |
|---|------------|---------|----------------|
| C | 44·44 | 52·65 | 49·2 |
| H | 6·17 | 5·25 | 6·1 |
| O | 49·39 | 42·10 | 44·7 |

* J. Bersch, "Die Verwertung des Holzes," 1893.

Cieslar* has shown that the amount of lignin in wood increases when a tree receives increased light and heat, which therefore affect all the technical properties of wood; these, therefore, depend chiefly on the relative volumes of cellulose and lignin in the wood. Unlignified tissues practically mean wood-formations that are not completed during late summer and are killed by early or winter frosts. It is not the absence of lignin in the cellulose walls that causes the susceptibility to frost, for neither cellulose nor lignin freeze, but the presence of plasma that is still constructive and has not passed over into its resting (winter) condition.

The presence of lignin in wood may be tested in various ways. Pure cellulose is coloured violet by chloro-iodide of zinc; lignified cell-walls are coloured cherry-red on the application of phloroglucin and hydrochloric acid; yellow by sulphate of anilin; and sky-blue under sunlight by a solution of phenol in hydrochloric acid.

By boiling wood in a solution of soda or caustic soda, or in a solution of calcium sulphate, lignin is removed from the cell-wall and pure cellulose is obtained.

Many fungi that are destructive to wood attack its lignin and leave the cellulose intact, whilst other fungi dissolve the cellulose, leaving a brittle, brown ligneous mass that may be pulverised by the fingers.

A chemical combination of the cell-wall with salts of alumina, such as was attempted in Haselmann's process for hardening wood, does not appear to be practicable; the alumina is merely attached to the wood and may be removed by rain, etc.

When wood is burned, its **ash-constituents** persist as a pale grey powder containing the mineral constituents of the wood. They are simple or double salts of potash, soda, magnesia, manganese, ferric-oxide, calcium-oxide, etc., combined with silicic, phosphoric, carbonic, acetic, pommic and citric acids. Although some of these constituents are essential for the life of plants, their effects on the quality of wood appear to be but slight; they penetrate it in all directions as an extremely fine mineral skeleton. Carbonate of potash is an economic product

* A. Cieslar, "Untersuchung über den Ligningehalt einiger Nadelhölzer." 1897.

from wood. The mineral matter in wood varies from 2 to 50 parts in a thousand; according to species; age of tree-parts (younger organs containing proportionally more ash than older ones); age of tree and nature of the soil in which the tree grew. Silicic acid is so abundant in bamboos and palms, especially near their outer rind, as to increase their hardness. [Silica in the form of a hydrate is found in the hollows of bamboo culms and termed *tabashir*, which is sold in Indian bazaars.—Tr.] Briar-wood (*Erica arborea*), that is used for pipes, is very rich in silica. Some tropical woods, such as ebony, cocus, etc., are very rich in mineral matter.

Water is the basis of the life of trees; after they are felled it is a worthless ballast in wood. Its great influence on the economic value of wood will be described hereafter; the section on specific weight may be consulted for an account of the distribution of water in a tree, and in its heartwood and sapwood.

Sugar, dextrin, albumen and tannin are decomposed easily, and form the chief nutriment of the fungi that destroy wood. The superior durability of winter-felled wood is explained by the fact, that during winter the above materials are in a fixed or resting condition, in which they are more resistant to decomposition. Wood that has remained for some time in water (floated or rafted) is also supposed to be more durable, because the above materials, being soluble in water, have been partly dissolved, and thus the fungi have lost part of their nutriment and their aggressiveness is reduced. This advantage is effective if followed by a subsequent complete drying of the wood to its air-dry condition, but practically this seldom happens, while the saturated wood requires prolonged desiccation. Hence floated wood is more susceptible to fungi than wood that has been transported by land.

[The materials above referred to serve also as food for insects, and bamboos that have been floated over long distances or soaked in tanks for several months are much more immune from insect-attacks than bamboos transported by land. The drying of floated wood after it has been landed is much more rapid also in hot countries than in Europe, so that floated wood is very durable under such conditions.—Tr.]

Sugar contained in the sap of certain species of maple, birch and palms is of economic value. In maples the conversion of starch into dextrin and sugar occurs only in winter with temperatures below freezing-point and so rapidly, that from January onwards, on days when it does not freeze, sap containing sugar exudes from wounds in the trees. The yield of sugar appears to depend on turgescence and pressure; sap does not exude by gravitation but is pressed out of the sap-wood. As soon as frost returns the sap ceases to exude; all maples yield fairly considerable quantities of sweet sap, which can be tapped without any apparent injury to the tree or the wood. When the buds open the annual exudation of sap ceases. Even European maples yield an agreeably scented syrup; if this were boiled, sugar could be made easily. This industry is largely developed in North America, and is referred to under the heading of the utilization of minor produce. The sap of maples contains five per cent. of sugar and more, that of birch, hornbeam and lime-trees, hardly two per cent. Fermented birch-sap is a drink.

Grains of sugar appearing on fresh wounds of the sugar-pine (*Pinus Lambertiana*) are used in medicine.

Starch is stored in the parenchymatous cells of living trees; in their external woody zones it is dissolved annually and used for new growth; according to Hartig, in old living wood (containing plasma) it accumulates until there is a seed-year, so that the periodicity of seed-years coincides with the maxima accumulations of starch. This statement is admissible only if it can be proved that in specially favourable warm years (1892, 1893, 1894), several successive seed-years can result from the accumulation of starch in the inner living zones of the same tree. Mayr believes that bright warm summers produce so much starch and other formative material as to suffice for the production of flower-buds, without drawing upon the resources of preceding years.

Starch increases the nutritive power of wood and together with mineral salts and albumen is stored chiefly in the finer branches and twigs, so that these tree-parts are specially nutritive for cattle and game. The older tree-parts are poor in nutriment, but in years of scarcity they may be mixed with

corn as wood-bread, and thus may partly replace other fodder. Such an experiment has been made with beechwood.

Tannin appears to play a varied part in wood, its most important rôle being that it precedes and includes the colouring-matter that gives its colour and durability to heartwood.

Among the **etheral oils** in wood, **turpentine** and **camphor** may be mentioned. Turpentine is contained partly in resin-ducts, partly in parenchymatous cells. If the resin-ducts are severed turpentine exudes; it is pressed out by the turgor of the sapwood. The cell-walls saturated with water are impermeable by turpentine. When wood is wounded and exposed, resin instead of water passes into the cell-walls (resinosis).

Camphor is found chiefly in Lauraceæ (*Camphora*); the species yielding it are given on p. 47. It is a highly refractive substance formed like tannin in enlarged parenchymatous cells.

Betulin occurs in the wood and bark of birches, and increases their combustibility.

D. MECHANICAL PROPERTIES OF WOOD.

This group of those properties of wood, which are based on its anatomical and physical conditions, is dealt with under a separate heading. Long technical experience is here more decisive than physical and anatomical science, which is not yet developed sufficiently to afford a clear explanation of the subject from a consideration of the separate physical and anatomical factors.

1. *Fineness of grain.*

The term "fine-grained" is not equivalent to "narrow-zoned," nor to "anatomically of simple structure." Wood that can be worked easily is fine-grained, whether or not it appears so to the eye. Oakwood as well as sprucewood may be fine-grained or coarse-grained. The woods of old Weymouth pines, of walnut, box, horse-chestnut and mahogany are specially fine-grained. One condition for fineness of grain is uniformity in the annual woody zones, both in width and in the ratios of the widths of spring and summer wood within the annual zones.

This uniformity of the tissues depends chiefly on the age

of a tree. At an advanced age the annual zones become gradually narrower, so that the annual increment may remain constant for a number of years. Mayr has shown that, as a tree becomes older and its volume of wood increases, it becomes less sensitive to variations in daily and even annual variations of atmospheric temperature and humidity. The large volume of wood then equalizes extremes of temperature, so that the cambium being equally nourished produces a steadier increment and consequently wood that is more finely grained than in young trees.

The method of growing a tree, and supplying it with light and heat is also important. Virgin forests yield wood that may be more knotty than wood from a dense artificial crop, but on clean boles exhibits the finest grain, the greatest uniformity of structure (Fig. 39). Excluding very old trees,



Fig. 39.—Wood from a virgin forest.

the explanation of this fact is due to the prolonged maintenance of the tree during youth in the diffused shade of the virgin forest; for decades the young plant has lived protected by older trees under uniform conditions of temperature, humidity and illumination, the forest equalising extremes. By the successive death of old neighbours, the tree obtains gradually a full supply of light and heat long after the passing of its youth, when meteorological extremes would have caused irregularity in its annual woody zones.

The gradual acquisition of an open position results in an increased increment, but not in abnormally wide and irregular annual zones. Wood from a Selection forest approaches this condition most nearly.

A tree grown under the Shelterwood compartment system, with a dense reserve of mother-trees (Fig. 40) possesses near its pith, wood, that has very narrow zones for the first 20 or 40 years; then, owing to full exposure to light, a number of

wide and irregular zones, but as the tree gets old the annual zones gradually become narrow and the wood resembles that from a virgin forest.

If, during the regeneration period, the tree serves as a mother-tree, wider zones follow, as in Fig. 42.

The **Clear-cutting system**, with artificial reproduction, secures from the first full light to the plant, also exposure to extremes of temperature and humidity. The wood is there-

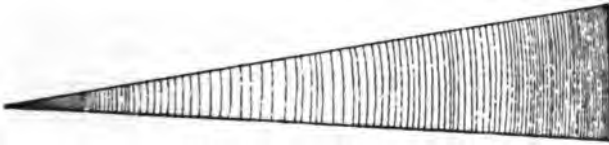

Fig. 40.—Wood grown under the Shelterwood Compartment system, just before a thinning.

fore broad-zoned from the first; zones of narrow summer-wood vary with others in which the hard summer-wood is broad, only in old age does the wood become uniform and narrow-zoned. The **clear-cutting system** produces the **coarsest grained wood**.

If a tree is set free when old (in Fig. 42 is a tree eighty years old) in the clear-cutting system, under the influence of the increased exposure to light and heat the annual zones

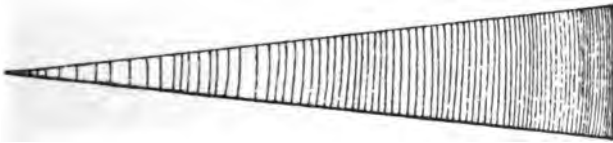

Fig. 41.—Wood grown under the clear-cutting system.

become wider, but gradually narrow again. Such wood is also coarse-grained (Fig. 42).

The inferiority of wood produced in the open is readily explained by the fact that a free position in young trees causes a larger wood-increment than in trees naturally regenerated.

It is indisputable that in old age it is not density of crop, but the open crop of a selection or virgin forest that produces the greatest volume of wood in a given time. Contrary to popular opinion, selection or virgin forest is not dense but open and

therefore produces the most underwood. Unfortunately the time required is longer than the usual rotations, and trees grown in crowded crops must be utilised early owing to low increment and disease (red-rot).

The influence of soil on the quality of wood is such that good soils produce woody zones that are broad and irregular, and consequently coarse-grained wood. The worst soil, or soil that is deficient in certain qualities, such as sand or peat, produce slowly grown crops, but wood that is finely grained.

In damp, cool climates, *i.e.*, maritime, northern or alpine climates, and on northern aspects, trees grow slowly in girth, and their wood is uniform in texture and finely grained. Norwegian, Swedish and North Russian wood is renowned for its fine grain, while the famous resonant spruce-

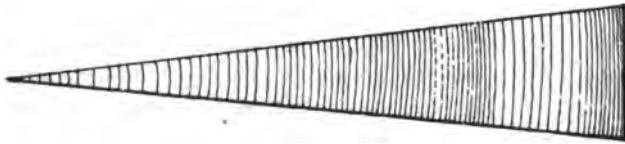

Fig. 42.—Wood of a tree that has stood in a free position both when young and old.

wood from mountains is the ideal of fineness of grain. Interference with the fineness of grain in wood, owing to knots, twisted fibre, etc., belong to the section on the defects of wood (p. 124).*

2. Fissibility.

The property of wood owing to which it may be split with wedges, etc., is termed **fissibility**, and depends chiefly on the **direction in which the force acts**. Fissibility is greatest when the splitting implement, *e.g.*, an axe, acts longitudinally and radially on a transverse section of the wood. Wood is less fissile when the axe strikes the tangential section along a radius, still less fissile when the wood is to be split along the annual zones, and this is easier on the transverse section than when the axe strikes on the radial section. Wood cannot be split if the force acts perpendicularly to the direction of its

* [Types of the wood of oak, larch, and spruce of various kinds of grain are given in the frontispiece, the last taken from Boppe's "Technologie Forestière."—Tr.]

fibres; it is indifferent whether this be radial or tangential. Penetration by an instrument is then possible only if the fibres are severed, while their severance is rendered more difficult owing to their compression by the instrument.

Fineness of grain is the next important item favouring fissibility, a straight uninterrupted course of the fibres renders a wood fissile; everything that favours or diminishes fineness of grain in woods increases or lessens their fissibility. Twisted fibre occurs sometimes in entire stems, and normally in the rootstock or at the junction of the stem with a branch; this diminishes the fissibility of the wood. Fissibility is annulled absolutely when the fibres alter in direction in consecutive annual rings, as in Guaiacum-wood.

High medullary rays, or numerous fine rays increase fissibility in the radial direction.

Moisture softens the cell-walls, so that contiguous cells are separated more easily, but they also become tougher. In hardwoods, the increased divisibility out-balances the toughness, so that they are split more easily when wet than when they are dry. In the Spessart freshly-felled oaks are split longitudinally to test their soundness. The opposite is the case with softwoods: their toughness when wet out-balances their divisibility; therefore they are more fissile when dry.

With woods that are equally moist, a higher temperature increases fissibility unless it also dries the wood. If the temperature is below freezing-point and the wet wood freezes, its fissibility is at once prejudiced; frozen wood breaks with a conchoidal fracture like a block of ice, as it resembles ice closely in its physical properties. This is another clear proof that when wood freezes, water is not exuded from the cell-wall, otherwise the sapwood of softwoods, especially of conifers, would become more fissile than before it was frozen. As water when frozen in the cell-walls reduces the fissibility of wood, the same result will follow when other substances replace water in the cell-wall.

All colouring-matters and resin therefore reduce fissibility. In extreme cases, when the resin hardens into rosin with which the wood becomes impregnated, fissibility disappears; such wood resembles frozen wood in this respect.

High **specific weight** is opposed to fissibility; it is more difficult to split heavy, hard woods, than the lighter woods. This applies also to wood from an individual tree, branchwood is less fissile than stemwood, even though the former be straight-grained, but rootwood, though lighter than stemwood, is less fissile, owing to irregularity in its fibres.

Soundness is a necessary condition for fissibility. Diseased wood is either soft or brittle, according to the nature of the disease; in either case it is less fissile than sound wood. Owing to the action of the attacking fungi, the wood at length becomes a homogeneous mass, which can no longer be split.

In judging the fissibility of the wood of **standing trees** the following favourable factors should be noted: Freedom from branches and knots; fine bark, with straight fissures. It is stupid and mischievous to cut out a piece of the wood and test its fissibility.

The following list shows how greatly fissibility depends on **species**.

| Very Fissile. | Fissile. | Fairly Fissile. | Difficult to Split. | Very difficult to Split. | Cannot be Split. |
|---|-----------------------------------|---|--|--|-------------------------|
| Bamboos. Canes, that can be split into threads. | Spruce. Silver-fir. Osiers. | Weymouth pine. Scots pine. Oak. Ash. Beech. Alder. Larch. Cembra pine. Yew. Hazel. Sweet chestnut. | Cherry-wood. Elms. Pear and apple- wood. Poplars. Tree-willows. Limes. Horse-chestnut. Maples. Birch. Mahogany. Teak. Plane. | Robinia. Cornus Mas. Black pine. Box. Ebony. Rosewood. | Guaiacum. Palm-wood. |

3. *Strength.*

The strength of a piece of wood varies with the direction of the force which tends to alter its shape, so that there are different kinds of strength in wood.

Tenacity is the resistance a wooden rod offers to a force tending to stretch it. The **coefficient of tenacity** is the force which can tear a rod one meter long and one square centimeter in

section, while the force that can stretch such a rod to double its length, if this were possible, within the limits of its elasticity, is termed the **modulus of tension**. [We may however say, with a greater regard to possibility, the modulus of tension is one million times the force, which would stretch the bar to a million times its length.—Tr.] These and other strength coefficients are given in kilograms per square centimeter, and as the atmospheric pressure on a square centimeter is very nearly a kilogram, the force is frequently represented in atmospheric pressures (at).

In the case of **resistance to crushing**, the force acts in the opposite direction to a tensile strain, and the coefficient and modulus are determined analogously. **Resistance to torsion** is that offered by the fibres of a rod, the axis of which is fixed, to a *couple* of forces tending to turn it on its axis. **Resistance to sheering** is that offered by wood to a force which tends to make sections of the wood slide on one another.

[None of the above strains (forces) or stresses (effects on the wood) are of much practical importance. In contrast with iron, fracture of wood by tension acts suddenly, there being little extensibility along its fibres. If a piece of wood be fastened at both its ends and then subject to a load in the middle, it may be bent and the fibres on the convex side are stretched, but the consideration of such a strain practically comes under the heading of transverse strength. Crushing strains come into play, when wood is used for vertical piles, or posts, mining props, wheel-spokes, etc. Over-weighted wooden pillars bend and break transversely.

Wheel-spokes are subject to crushing strains and the best woods for the purpose are **robinia** and **oak**; the former wood is now coming into use for the spokes of motor-cars, where the pressure on the outside wheels in going rapidly round curves is very great. In using peeled oak coppice-shoots for pit-props it is essential that the horizontal cut made at the base of the shoot in order to strip off the bark should sever none of the wood-fibres, as any such cut very greatly diminishes the strength of the prop.

Mathey (op. cit., p. 7) goes into detail on the question of the strength of pit-props, which were tested in 1891—1895 by

Emile Sardino, and the general results obtained by the latter for props 14 c. in diameter at the small end are as follows :

| | Breaking-weight in kilos. |
|--------------------------------|------------------------------|
| Oak | 5,220 |
| Maritime pine | 4,790 |
| Silver-fir or spruce | 4,750 |
| Larch | 4,310 |
| Scots or Black pine | 3,740 |

With a diameter of 18 c. the superiority of oak was further accentuated, but the larch came at the bottom of the list. It was presumably of bad quality.

The windlass is about the only case in which wood is required to resist torsion, and the dimensions of wooden windlasses are usually sufficient. Guaiacum-wood resists sheering strains best, as in pullies; beech, apple and pearwood also resist sheering well, hence the use of these woods in golf-clubs. Hornbeam-wood resists both crushing and sheering strains and is used for cogs and skittles. When subject to a crushing strain, according to Laslett, its fibres, instead of breaking off short, double up like threads.—Tr.]

The most important strength of wood is the resistance it offers to a force acting at right angles to its grain, and is termed **transverse strength**. As long as the change in the form of the piece of wood is only temporary and it recovers its original shape after the strain is withdrawn, the wood is said to be **perfectly elastic**. If, however, a change of form remains after the withdrawal of the strain, the limits of perfect elasticity have been exceeded. The **modulus of elasticity** of a piece of wood corresponds to its change of form until the limits of elasticity have been reached, while the **modulus of rupture** gives the force in kilograms, when breakage results, after the limits of elasticity have been exceeded.

Investigations regarding the strength of wood date from the early part of the nineteenth century; it was chiefly Duhamel du Monceau who attempted to discover a relation between the specific weight of wood, that is so easily determined, and its strength, the determination of which is much more difficult.

Duhamel considered that specific weight is a measure of the strength of wood, and he was followed in this way by other investigators. Hartig* and his pupils went too far in this direction, as they affirmed the identity of heavy = strong, and of light = weak, stating that heavy sprucewood is always stronger than light sprucewood; they forgot that the most costly and excellent sprucewood, resonant wood, is the lightest wood of this species. Omeis followed Hartig in basing strength on specific weight only, in the case of Scots pine; Eichhorn for oak; Bertog for silver-fir; Schneider for ash. The best works on the subject are given below.†

Tetmajer gives the following data in tons of 1000 kilos per square centimeter of wooden rods, half a meter long:—

| Species. | Modulus of Rupture. | Specific weight of air-dry wood. |
|-------------------|--------------------------------|----------------------------------|
| Silver-fir | 100·2 | 46 |
| Oak | 102·7 | 76 |
| Spruce | 110·9 | 47 |
| Larch | 114·4 | 60 |
| Scots pine | 118·8 | 52 |
| Beech | 168·5 | 72 |
| | Modulus of elasticity (lineal) | |
| Scots pine | 0·188 | 52 |
| Larch | 0·206 | 60 |
| Spruce | 0·210 | 47 |
| Oak | 0·217 | 76 |
| Silver-fir | 0·224 | 46 |
| Beech | 0·240 | 72 |

It cannot be affirmed from Tetmajer's results that the moduli of strength and elasticity are correspondent. Most

* R. Hartig, "Untersuchungen über die Entstehung und Eigenschaften des Eisenholzes." "Verschiedenheiten in der Qualität u. im anatomischen Bau der Fichtenholzes." Forstlich Nat. Zeitung, 1892, 1893, 1894.

† Nördlinger, "Die Elastizität der Hölzer." Zentrbl. f. d. ges. Forstwesen, 1887—89. Bausinger, "Elasticität u. Festigkeit verschiedener Nadelhölzer." Munich, 1883, 1887. Schwappach, "Untersuchungen über Raumgewicht u. Druckfestigkeit des Holzes," 1897, 1898. Bühler, "Untersuchungen über die Qualität des in lichten u. geschlossenen Stand erwachsenen Tannen u. Fichtenholzes." Landolt, "Prüfung der Festigkeit u. Elastizität der Bauhölzer." Schweiz Zeitschrift, 1886. Hadeck u. Yanka, "Untersuchungen über die Elastizität u. Festigkeit der österreich: Bauhölzer, I. Fichte Südtirols," 1900. Tetmajer, "Prüfung der schweizerischen Bauhölzer," 1883—1896. Fernow and Roth, in several pamphlets on the strength of American woods. "Reports on the strength of structural timber," W. K. Hatt, United States of America Forest Service, Circular 115, Oct. 24, 1907.

investigators have not calculated the limits of elasticity, but have stated that the two moduli correspond.

As regards specific weight, they affirm that for any species, heavier wood is stronger, so for two species of spruce, the heavier is stronger and more elastic. Schwappach goes more into detail on the connection between specific weight and transverse strength, stating that :

Transverse strength, depends on :—

(a). **Tree-parts.** The external wood is the strongest, also usually the heaviest. In the crown of a tree, sometimes the weight, sometimes the strength is greater. The so-called **hard and heavy side of coniferous trees** is **weaker** than the so-called **soft side**. According to Föppel* also, the wood of the upper side of branches is stronger and more elastic than that of their lower side, so that lighter wood is stronger than heavy wood.

(b). **Age.** Old wood is stronger, though lighter, than young wood ; in the Scots pine, specific weight diminishes after a tree is sixty years old, but strength increases.

(c). **Locality.** The strength diminishes as the tree is grown away from its optimum climate (*cf.* p. 56).

(d). **Soil.** The best soil produces the strongest wood ; it has been shown already that the best soil does not always produce the heaviest wood.

(e). **Wetness of the wood.** Variations of 1 per cent. in wetness give differences up to 8 per cent. in strength.

Schwappach hence decides that **specific weight alone is no determining cause of strength.**

Only after eliminating the results of age, locality and method of production, and after seasoning the wood, is its strength dependent upon its specific weight alone. Thus in order to avoid one mistake further investigations involving fresh sources of error must be undertaken. Tetmajer states that the proportion in which cellulose, lignin, gums, etc., are mixed in the cell-wall does not affect specific weight, nor does the mode of union of these materials with one another, nor that of adjacent cells (cohesion). Tetmajer alleges that the amount of deformation, which in tests of strength, occurs in displacement of

* R. Hartig, "Holzuntersuchungen Altes u. Neues." Berlin, 1901.

the molecules, is a very important factor, but specific weight gives no indication of this. With these results before him, Mayr concludes that to foretell the strength of wood by means of its specific weight is like a forecast of approaching weather, from no factor except the position of the barometric column. We must therefore try to produce the cleanest, straightest and most cylindrical stems in the least possible time, whether or no such timber is heavy or light.

The strength of a beam depends on the manner in which it is supported, and the point of action of a straining force; a beam supported at one end and laden at the other possesses only one quarter of the strength of the same beam, when supported at both ends and weighted in the middle. If after the weight has been applied and removed there is a change of form in the beam, the limits of elasticity have been exceeded. It has been assumed that this limit is half that of the breaking strain, that a beam which breaks with eight tons loses its elasticity with four tons. In engineering structures employing wood the limits of elasticity are never permitted to be approached, especially as Haupt and Thurston have determined that the limit of elasticity is much lower when the load is permanent.

Another very important item in the strength is the transverse shape of the beam, and the direction of the annual zones with respect to the supports. The transverse strength is greatest when the section is a rectangle with its sides in the ratio 10:7, the beam resting with its narrower side on the support. Such a beam exhibits the maximum strength (100) when the annual zones are approximately perpendicular to the supporting surface (Fig. 43 *a*).

If such a beam rests on its broader side, its strength is 60 (Fig. 43 *c*). A beam with a square section but of the same area as (*a*) has a strength of 75 if the annual zones are nearly perpendicular to the supporting surface (Fig. 43 *b*), 65 when the annual zones are parallel to the supporting surface. A rectangular beam with the pith in its centre and placed on its narrow side has a strength of 90 (Fig. 43 *d*) and if square of 70 (Fig. 34 *e*). (Another test gave $b = 84$, $c = 70$.)

The way in which a beam is cut out of a log also affects its

strength. If a piece of wood is subject to great pressure, as in wheel-spokes or ladder-rungs, it should be split or cloven from the log, as, by sawing or hewing, many fibres are cut, whilst by splitting, all the fibres remain in their natural length.

Evenness of grain in the annual rings and approximately vertical fibres denote strong wood. Any interruption of the straightness of grain, caused especially by enclosed branches, reduces the strength of the beam considerably.

Since the elasticity of a beam is ascribed correctly to the amount of lignin it contains, exposure to light and heat

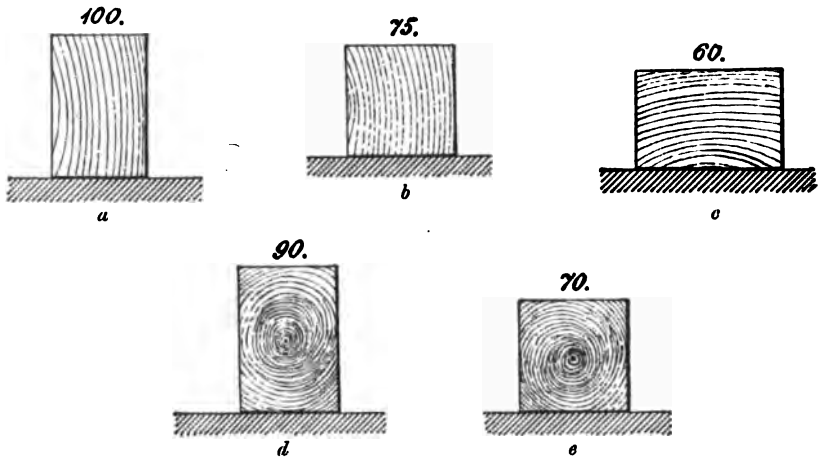

Fig. 43.—Ratios of the strength of different beams of the same section in area, but of different shapes.

during the life of a tree must be favourable to the strength of its wood, for Cieslar has shown that the cell-walls become more lignified the more light a tree receives. On the other hand, wood, especially that of suppressed poles, grown in a dense crop is tough, but less elastic and strong. Practical experience confirms this statement, for spruce poles grown in open woods belonging to peasants, called "white stems" on account of the lichens that cover them, are more durable and elastic than "red poles" taken from thinnings in a dense wood. The opinion of timber-merchants that mountain-wood is more elastic than valley-wood is also partly true.

Contents of resin has a slightly reducing influence on strength, for very resinous wood is brittle and weak.

The employment of wood in **high air-temperatures** is conducive to strength, because the wood becomes dry. Temperatures below zero weaken the strength of wood considerably; when wet wood is frozen it becomes brittle and approaches ice in its strength.

That **humidity** weakens wood has been already stated, and the experiments of Schwappach and Rudeloff confirm this.

To the **season of felling** an influence on the strength of wood has been assigned; wood felled in December is said to be the strongest. Anyone, however, who has undertaken to test this and who knows the numerous sources of error that arise in such investigations, can only warn practical men to beware of such a statement.

Every disease in wood reduces its strength considerably.

No list of woods ranged in the order of their elasticity can be drawn up without a suspicion of prejudice, especially with regard to the method adopted for testing them, and also because individual trees of the same species vary greatly in strength, even when taken from the same crop. Soil, climate, the method of rearing trees, etc., also cause great differences in strength. Sometimes oakwood, sometimes ashwood, is chosen as the strongest and most elastic material. Actual tests have placed conifers above broadleaved trees in strength. Scots pinewood that is so brittle when exposed to snow has been placed first among elastic woods. Tests have shown that beechwood possesses considerable strength, while in practice, beech, birch and alder are reckoned as woods with the least transverse strength, but with considerable resistance to crushing. There is no doubt that certain foreign woods are more elastic than our indigenous woods, *e.g.*, hickory (*Hicoria alba*), teak, sundri (*Heritiera*), lancewood (*Duguetia*) and bamboos.

4. *Toughness or Pliability.*

A wood is said to be tough or pliable when it can be bent beyond the limits of perfect elasticity and is then susceptible of permanent deformation without breaking. The greater the interval between its limits of elasticity and rupture the

tougher is the wood, and toughness has already been taken into account in the discussion regarding the strength of wood. In practice an unpliant wood is termed brittle. Pliability in wood from one species of tree or part of a tree depends chiefly on **specific weight**; **heavy wood is less pliable than light wood**. The branches are less pliable than the stem, and the stem than the roots; the finer rootlets are used as withes. The rhizomorphs of the honey-fungus (*Armillaria mellea*) are more pliable than the finest rootlets of trees. Soft broadleaved wood is generally more pliable than hardwoods, but on the other hand the wood of *Hicoria alba* is much more pliable than the lighter, brittle wood of *H. amara*.

Rapidity of growth favours pliability, and **coppice-shoots**, such as osier-willows and shoots of oak, birch, ash, elm and hazel are very pliable.

As lignin in woody tissues specially determines hardness and strength, so **cellulose** confers on wood toughness and pliability. The less the illumination under which the tree has been grown, the more pliable it is. The very pliable coppice-shoots are nourished chiefly by reserve material from the stools and roots and get very little nourishment from light. The produce of thinnings is tough and pliable, but not so hard and elastic as well-lignified stems grown under complete illumination. [Woods grown on northern aspects are more pliable than the harder and more lignified woods grown on southern and western slopes, and the same is true for woods grown on moist soil, as compared with dry calcareous soil, or peat, which produce brittle wood.—Tr.]

Moisture increases the pliability of all woods. Hence in freshly felled trees, the sapwood is tougher than the heartwood; hardwoods when wet are tougher than when they are dry, but the loosening of the walls of their tissues by the water preponderates over the resulting toughness (*cf.* p. 87).

Heat also increases pliability if precautions are taken to prevent evaporation; heat and moisture acting together render wood extremely pliable, so that steamed rods and planks can be bent just as if they were formed of homogeneous material,* as in

* W. Exner, "Das Biegen des Holzes." Zentralblatt f. d. ges. Forstwesen, 1876.

steaming wood for chairs, banisters, curved planks used in carriages, ships and barges, musical instruments, etc. **Frozen wood** is hard and brittle.

When **resin** (semi-liquid turpentine) replaces water in wood, pliability is diminished, wood charged with rosin or colophany (oxidised turpentine) becomes harder, the longer the rosin has been in its tissues.

The **colouring-matter** in heartwood diminishes the pliability of wood.

The following list shows that pliability depends greatly on **species**, but in practice there is much difference of opinion on this subject.

SPECIES ARRANGED ACCORDING TO THEIR PLIABILITY.

| Pfeil. | Other Investigators. |
|---|--|
| Hickory. Ash. Elm. Hornbeam. Larch. Scots pine and Spruce. Oak. | Birch. Ash. Willows. Poplars. Cork Elm. Hickory. Species of Pirue. Coppice-shoots of various broadleaved trees. Suppressed Spruce. Acer dasycarpum } very brittle. Robinia |

5. *Durability.*

Durability is a measure of the time during which wood remains sound. In using and storing wood it appears that the durability of any species of wood varies remarkably. For instance, beechwood, when made into furniture that remains inside our houses, may last for centuries, but the same wood, when exposed to moisture from the soil, rots in from three to five years, while under water it can be kept sound for decades. As a rule we understand by the term durability a measure of the duration of wood that is used more or less in contact with the ground, as for posts or railway-sleepers.

The various forms of decay in wood are, as follows :

Greyness.—Wood that is not exposed to ground-moisture but to atmospheric influences and precipitations, variations of

temperature, insolation, etc., turns grey. The pale tints of freshly utilised wood, as in fences, become darker when its tannin is oxidised, and though this may increase its durability temporarily, the wood becomes gradually grey owing to the slow decomposition of its external layers. The lignin is dissolved first, leaving a substance that is richer in cellulose. The exposed cells are gnawed by various species of wasps in order to obtain wood-pulp for their nests.

Softwoods turn grey earlier than hardwoods, and spring-wood is attacked before summer-wood, hard knots and resinous parts of the wood offering most resistance. Local climate affects this decomposition greatly, for in maritime and mountain climates wood (*e.g.*, shingles on roofs and walls of buildings) becomes grey much sooner than in dry continental countries. Thus, in North America, Weymouth pine shingles last for about five years near the Atlantic coast, but for ten years and more in the Prairies. Planed planks resist greyness longer than planks that are merely sawn.

Humification, or eremacausis, affects wood when it is exposed constantly to atmospheric humidity and obtains insufficient supplies of oxygen. Wood buried in the ground, or in mines, shafts, ship-cabins, cellars, inside hollow trees, etc., is exposed chiefly to this form of decay, which, besides being due to chemical decomposition, is also assisted by fungi; the final product is damp, powdery, brown mould. In such places, according to Mayr, fungi appear whenever the relative humidity of the air attains 70 per cent.; when the air is less moist and fungi are absent the wood decomposes more slowly.

Rottenness is the decomposition of wood by the agency of fungi, when the wood being supplied fully with atmospheric oxygen is exposed also from time to time to humidity. All wood in contact with the ground is in this condition, *e.g.*, floors, posts, or railway-sleepers. The eventual product is a rotten, moist, pale or dark brown substance, with a fracture partly fibrous and partly crumbling, and is scented like humus or fungi. Wherever the variations of moisture are greatest, as just above, at, or just below, the surface of the ground, rotting is most rapid and continuous. Stakes,

poles and posts in the ground break eventually at their point of contact with it.

The surface of wood exposed to flowing water becomes **slimy**, owing to the action of bacteria, especially *Leptothrix*, but wood in this condition is very durable.

Mechanical attrition by natural agencies occurs in rapid watercourses, such as mountain-torrents carrying sand and gravel, the continual impacts of which on wood wear away its surface. A similar action takes place near the sea-shore, when the wind blows grains of sand against the wood, as near sand-dunes. Planks and beams that are exposed to the sand resist it best at their hard knots, which eventually protrude beyond the rest of the wood in polished conical projections.

Wood is converted into peat, or becomes carbonised, after lying for long periods of time in wet peat. It retains its structure, but is converted gradually into soft peat or eventually into lignite, but sometimes may be utilised as bog-oak, etc., hardening considerably after it has been removed from the bog and has been dried. Wood from forests that have been submerged by the sea resembles bog-wood. In Japan whole forests have been destroyed by volcanic eruptions and buried in ashes or lava. This wood is at first of a silver-grey colour (Indai-wood of the Japanese), but later becomes brown and loses its structure, forming a homogeneous mass like jet (Umoregi).

It is obvious that in many modes of utilisation of wood a piece of wood may be exposed to two or even three kinds of decay. Thus, bridge-posts are subject to grey decay above water-level and to attrition below it, while a gate-post becomes grey above ground, rotten near the surface of the ground, and humified at its lower end.

Usually a wood is held to be more durable the longer it resists rottenness and humification; this is **natural durability**, as opposed to **artificial durability**, due to impregnation with antiseptic substances.

The natural durability of the wood of any species of tree depends in the first place on its position in the tree; **heart-wood** is always more durable than sapwood, even heartwood

without distinct colour, as in spruce, silver-fir, or birch; for heartwood contains no easily decomposable albuminous constituents, and is always drier than sapwood.

The presence of colouring-matter in heartwood, however, increases durability greatly; woods with coloured heartwood are always more durable than woods with heartwood and sapwood of a uniform colour. Mayr also states that the more intense the colour of the heartwood the more durable it is. The imperfect heartwood, or internal sapwood, of oaks, that occurs occasionally in annular zones in the midst of perfect heartwood, characterised by the absence of thylosis and tannin and the presence of starch and so faintly coloured that it resembles sapwood, is no more durable than is normal sapwood (*cf.* p. 142).

In the following tabular form, woods are grouped according to the colours of their heartwood:—

COLOURS OF HEARTWOOD.

| Black, Brown, Red. | Grey, Light Brown, Bright Red, Yellow, Yellowish Green. | Light Yellow, Light Reddish Grey, Light Brown. |
|---|--|--|
| Ebony. [Mahogany. Padauk. Jarrah. Karri. Cedrela. Yew. Maury tropical woods.—Tr.] Rosewood. Catalpa. Mulberry. Pencil-cedar. Swamp-cypress. Sequoia sempervirens. Larch. Douglas fir. (All very durable.) | Magnolia. [Teak.—Tr.] Tulip-tree. Robinia. Oak. [Sweet chestnut.—Tr.] Pines, including Weymouth pine. Chamæcyparis obtusa. " pisifora. Giant thuya. Hemlock spruce. Torreya. [Sallow, red and fairly hard, and durable.—Tr.] Elm. (All durable.) | Beech. Birch. Horse-chestnut. Ash. Maple. Lime. Spruce. Silver-fir. Hornbeam. [Holly, white and fairly durable.—Tr.] Alder (red heartwood). Lawson's cypress. Cupressus sempervirens. (All, but holly and the two last, not durable; the two cypresses are very durable.) |

The exceptions in this list to Mayr's law about the correspondence of high colour and durability are the two cypresses, holly and alder. The heartwood of all cypresses contains ethereal oil and is very durable; in alder-wood, though the heartwood is of a high colour, this is due to an oxidised

product from a colourless chromogen. [Deodar-wood is also pale yellowish-brown but extremely durable.—Tr.]

The colouring-matter in heartwood is derived from tannin ; as the water disappears from the tissues and oxygen is admitted, it is formed by oxidation in the border zone separating sapwood from heartwood. This requires complete illumination of the tree's foliage ; the colour is deepest in the heartwood of branches, it is paler in the stem-wood and palest in the roots. The colour of the heartwood is also deeper in the wood of trees that have grown in full sunlight than in those grown in a crowded crop or under the shade of other trees ; therefore the wood of trees exposed to full light is more durable than that of trees grown in restricted light. The influence of thinnings and of setting trees free from their neighbours and retaining standards over underwood on the increased colour and durability of their wood is therefore evident.

The deepest colours and the greatest durability occur in the heartwood of certain tropical trees ; in cooler climatic zones the colours are less deep and the woods less durable. In the coolest climate, indeed, perishable sprucewood and very durable larchwood are produced, but as a general rule it may be predicated for broadleaved trees within their native habitat, that **great heat implies durability.**

Turpentine becomes oxidised into rosin, which possesses extraordinary durability : the more gradual is this process, the greater the quantity of liquid and volatile oil that is converted into rosin ; such a transformation is secured by keeping coniferous wood as long as possible in the form of logs or balks. **The effects of rosin on the durability of wood** are not, however, sufficient for it to replace other factors, *e.g.*, colouring-matter. Weymouth pine contains more turpentine than any European conifer except maritime pine, yet its wood is not nearly so durable as that of larch, which contains little turpentine, but much colouring-matter. The greater durability of sprucewood than the wood of silver-fir is, however, due to its being the more resinous of the two.

Wet wood is always less durable than dry wood, for wet wood in the form of logs or balks requires two or three years

to become air-dry, and during this interval there is always danger of infection by fungi, which do not attack dry wood. When wood has been floated or rafted, part of its soluble contents, albumen, sugar, gums, etc., have been removed, but it is so saturated with water that the danger of infection by fungi is increased. The nature of the soil in contact with which the wood is used, *e.g.*, sand, loam, or swampy ground, affects its durability. Also the locality, *e.g.*, a shaded or sunny slope, a damp valley, a cool, windswept upland. [In all these cases it should be noted that in order to cause wood to decay three factors are necessary, heat, water and oxygen. The exclusion of one of these factors suffices to preserve the wood. In very wet soil oxygen is absent and wood lasts long. The wood of mummy-cases is practically imperishable in Egypt, where water is the absent factor. At Silchester, in Berkshire, three silver-fir casks were dug from a Roman well that had been filled with earth at the time of the Saxon invasion, presumably about 1,400 years ago; this wood, naturally very perishable, is still in excellent condition in the Reading Museum, as the clay that filled the well had excluded oxygen.—Tr.]

The question whether, in order to produce durable wood, **fellings** should be made in **winter** or **summer** is as old as the hills, and is really insoluble, as it is impossible to exclude all disturbing factors and experiment with one only. In any case the difference in durability of the wood cut in summer or winter is confined to the sapwood. [In the Forest of Dean the boles of oak-trees are stripped of bark in the spring and remain with their foliage transpiring moisture, and their exposed wood evaporating it all the summer and autumn; this renders the wood when felled in winter very dry, and must increase its durability.—Tr.]

All articles made of wood for human use are liable to **wear-and-tear**, especially floors and street-paving. **Hardness** and **high specific weight** are the best qualities to ensure durability in such cases. As atmospheric influences also tend to destroy street-pavement, hard, deep-coloured heartwood of any tree is the most suitable material, *e.g.*, oak, larch, pitch-pine, etc. For this reason Australian hardwoods, such as Karri (*Eucalyptus*

versicolor) and Jarrah (*E. marginata*), and Indian iron-wood, *Xylocopa dolabriformis* (Pyngado), are used in London.

Woods wear away most rapidly when their radial or tangential sections are above; as, however, these sections exhibit the beautiful silver-grain of the wood, they are used for *parquets*, while in street-paving only the transverse sections are laid uppermost.

The animals that reduce the durability of wood in buildings and furniture are chiefly insects, which construct passages in wood for laying their eggs and for the development of their young broods. Their presence may be detected by the occurrence of little holes in the wood and the exudation of boring-powder. Among the worst enemies of wood are little beetles and their larvæ, such as *Anobium tessellatum* and *A. pertinax* (the death-watch); *Tomicus lineatus* (also in living trees); *Dermestes*, chiefly in broadleaved wood; *Limexylon navale*, in oak-wood in dockyards. Species of *Tetropium* and *Sirex* bore into larch and other conifers. In the tropics, and even in Southern Europe, white ants (*Termites*) are extremely destructive to wood, sparing only very few species.

[Bamboos are very subject to be wormeaten, especially the yearling culms, which are very soft and sappy. Only 3 to 5-year-old culms, which are thoroughly lignified, should be used as rafters, and these only after several months' soaking in a tank, or after being floated long distances in rafts on a river. The natives of India believe that bamboos felled during bright moonlight nights become wormeaten much more readily than those felled during the dark half of the month when the moon does not shine at night. An experiment was made by the translator at Dehra Dun in 1886 to determine this, and 100 bamboos were cut during the bright moonlight and 100 cut during the dark part of the month, and the former were much more wormeaten than the latter. It is probable that certain insects, the larvæ of which attack bamboos, fly only during the bright moonlight nights, when they lay eggs in the bamboos.]

Further investigations on this subject were made in Madras in 1898 and subsequent years, and these are described by E. P. Stebbing in the *Indian Forester*, November, 1906. The insects in question are said to be *Dinoderus pilifrons* and *D. minutus*. The experiments were not conducted scientifically, and Stebbing suggests further experiments to decide this question. E. R. Woakes, in a paper read before the American Institute of Mining Engineers and printed in the *Tropical Agriculturalist* for October, 1899, states that in the Republic of Columbia, in South America, "not only bamboos, but all timbers, are felled during the waning moon."

Whenever poles containing only sapwood, or bamboos, are used for rafters, evidently they should be dried thoroughly; when exposed to smoke, as they are in the roofs of Indian huts, this prevents further danger from insects.

The wholesale destruction of most woods in hot countries by **termites**, or white ants, is well known, and the number of woody species in India which resist their attacks is very limited. Even deodar wood, in spite of the oil with which it is saturated, is sometimes attacked by them, and the sapwood of every wood is eaten away very rapidly. The heartwood of sal (*Shorea robusta*), teak, tûn (*Cedrela Toona*), ebony, sissu (*Dalbergia Sissoo*) and some other hard woods resist their attacks, but in the case of building-timber it is always best to saturate it with *gurjun*-oil, extracted from *Dipterocarpus*



Fig. 43A.—The Teredo. (After Boppe).

turbinatus. Engineers in India should be careful to erect only solid masonry-walls, and not leave crevices in them up which the white ants may ascend to the roof of a building; also they may mix arsenic with their mortar with advantage.

It has often been suggested that softer woods if injected with creosote, sulphate of iron or zinc, or corrosive sublimate (bichloride of mercury), would be found to resist the attacks of white ants, but no serious attempts have as yet been made in India to utilise injected wood. Termites occur everywhere in India, up to altitudes of about 4,000 feet above sea-level.

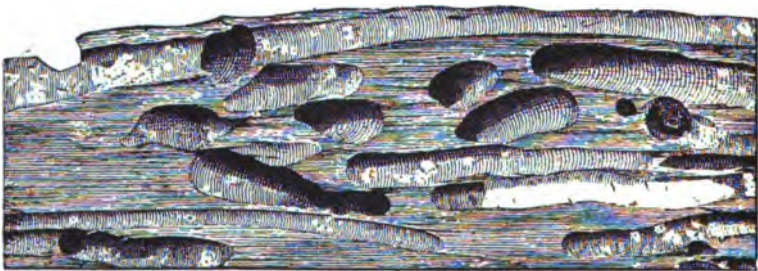

Fig. 44.—Borings of the Teredo. (After Boppe).

In order to preserve museum wood-specimens from insects, it is best to dip them in a solution of one part of corrosive sublimate to twenty parts of water.

Ethereal oils in woods, especially in those that are strongly scented, protect them from insect-attacks, though the presence of resin is not always a protection.

Wood immersed in fresh-water is very durable, even beechwood lasting for centuries. In the year 1858, twelve oak piles of the Roman bridge near Aargan came to the surface, and the wood was hard enough to be made into toys.

Wood used in sea-water at shipping ports and stores of wood kept under water at these places, are subject to the attacks of certain animals. Some

small crustaceans, *Limnoria terebrans*, Leach, and *Chelura terebrans*,* Philippi, bore into and gnaw the surface of all woods in sea-water. The mollusk, *Teredo naralis*,† L. (Figs. 33 and 34), and other species of *Teredo*, are however the most destructive pests of south European seaports. Teredos attacked wood in the Eocene period (London Clay).

Teredos live only in sea-water and bore not only the sapwood, but also the heartwood of all kinds of timber, except the Jarrah ‡ (*Eucalyptus marginata*). Ships, the bottom of which are not covered with copper, suffer greatly from teredos. Wooden piles used in harbours, etc., may be protected by being creosoted, but this is serviceable only when the wood is thoroughly saturated with creosote; as coniferous wood imbibes creosote better than oakwood, when creosoted it is better than oakwood for use in dams and other harbour-works. Attempts have been made to protect piles in sea-water by studding them with broad-headed nails, but the little teredos force their way into the wood between the heads of the nails. In the years 1827 and 1859, when the rainfall was very slight and the Dutch canals near the sea coast became very salt, it was found that all the piles supporting the dams along the Dutch coast were bored by teredos. A Commission was appointed in Holland, in 1859, to enquire into the causes and possible remedies of this damage, and from its report, written by v. Baumbauer and quoted in Ratzeburg's *Forstinsectenkunde* (by Judeich and Nitsche, 1889), the above remarks have been taken. It is also stated by Nanquette,§ that when timber is stored in sea-ports for ship-building and harbour-works, it should be kept either in banks of mud, or in tanks in which sufficient fresh-water is mixed with sea-water, so as to render it less saline than is necessary for the life of the teredos.—Tr.]

Numerous fungi, chiefly of Basidiomycetes, destroy wood. This is principally because wood that has been already attacked by fungi, in the forest, is brought to the market in a moist condition, or because air-dry wood is used in moist places. The number of species of destructive fungi that attack converted wood is much greater than those described in books. Should one be obliged to live in a humid climate or in damp houses not only the most destructive of house-fungi, dry-rot (*Merulius lacrimans*) appears, but also numerous species of *Polyporus*, *Trametes* and *Coprinus* appear, which gradually destroy all the woodwork in a house. Most of these fungi attack first the sapwood of converted timber and then the heartwood; some (*Trametes*) live in the heartwood only. Some fungi cause white rot, others red rot, the wood in both cases becoming eventually a soft, crumbling, structureless mass. R. Hartig has described the fungi destructive to wood

* Vide Ratzeburg's "Forstinsectenkunde," by Judeich and Nitsche, 1889, p. 337 ff.

† Vide "Encyclopædia Brit." 1888, vol. xxiii. p. 184.

‡ "Laslett," *op. cit.* p. 5.

§ "Exploitation des Bois," 1863.

in his classical works referred to below.* Regarding "dry rot" Göppert and Hartig have published treatises.†

[The International Association for Testing Materials, December, 1898, formulated two questions regarding dry rot:—

1. Can infection of wood by *Merulius lacrimans* be recognised before it is used?

2. What are the best methods of preserving the wood?

The former question has not yet been answered. For the second thorough drying and painting the wood with antiseptics suffices. Creosote is the best antiseptic, but is inflammable. *Vide* Henry, Rev. des E et F, page 65, 1901, and September 1, 1902. In order to test the comparative durability of certain woods Hartig placed heartwood beams 10 C. in diameter, of the following species in the ground. The years given in the statement below denote the period in which the wood was completely rotten.

| 5 Years. | 10 Years. | 14 Years. |
|---|---|---|
| Norway maple. Beech. Lime. Birch. Poplars. Horse-chestnut. Rowan. | Silver-fir. Spruce. Common maple. | Oaks. Elms. Sycamore. Plane. Weymouth pine. (Larch, robinia, and Scots pine (130 years old) were then quite intact.) |

In the damp, warm air of mines, some experiments made at Commentry gave the following results for pit-props, the species being arranged in their order of durability‡:—

- | | | |
|-------------------|-------------|---------------|
| 1. Oaks. | 6. Robinia. | 11. Cherry. |
| 2. Scots pine. | 7. Willow. | 12. Birch. |
| 3. Alder. | 8. Maples. | 13. Hornbeam. |
| 4. Ash. | 9. Elm. | 14. Beech. |
| 5. Maritime pine. | 10. Aspen. | 15. Poplar. |

* R. Hartig, "Die Zersetzungserscheinungen des Holzes der Nadelholzbalime u. der Eiche." Berlin, 1878. "Lehrbuch der Baumkrankheiten," 3 Aufl. Berlin, 1899. See also, "Schlich's Manual of Forestry," vol. iii. "Forest Protection," by W. R. Fisher, 2nd ed., 1906.

† Göppert, "Der Hansschwamm." Breslau, 1885. R. Hartig, "Der Hansschwamm." Berlin, 1885.

‡ These data are given by Mathey, *op. cit.*

As fungi do not occur below one or two feet from the surface of the ground, and bacteria that assist greatly in destroying wood in contact with the soil are found only in its superficial layers and not in peat, deep immersion in the soil, or in peat, preserves wood, as has been stated already.—Tr.]

6. *Heating-power and Combustibility of Wood.**

There are various methods for determining the heating-power of wood. As burning wood takes oxygen from the air and gives out carbon-dioxide and water-vapour, the mass of oxygen requisite to burn a given mass of wood can be measured: the more oxygen is needed for the combustion of the wood, the more carbon the wood contains and consequently the greater is its heating-power. The amount of oxygen may be determined by burning the wood in a closed retort with a metallic oxide (red lead). This chemical method does not give the utilizable heating-power of the wood but only the percentage of carbon it contains; the variations in the mass of carbon in wood when measured by weight are small, though if measured in volume, the results exhibit a steady relation between the heating-power and specific weight of wood. The average volumes of carbon, hydrogen, oxygen and nitrogen in wood and other combustibles are given below:—

| | | C. | H. | O. | N. |
|------------|-----|----|-----|------|-----|
| Wood | ... | 50 | 6 | 48·7 | 1·3 |
| Peat | ... | 59 | 6 | 34·5 | 0·5 |
| Lignite | ... | 68 | 5 | 26·6 | 0·4 |
| Coal | ... | 80 | 5 | 14·0 | 1·0 |
| Anthracite | ... | 95 | 2·5 | 2·0 | 0·5 |

In physical methods for determining heating-power, the wood is burned with free admission of unlimited oxygen; the mass of ice that is melted, or the quantity of water that is converted into steam, by burning equal volumes of different kinds of wood, is then ascertained. Also the rise in temperature of a certain volume of water by the burning of the wood may be measured.

* Fritz, "Die Heizmaterialien u. deren Ausnutzung." 1877. Fuchschmid, "Brennwert verschaedener Holzarten." 1890.

In the last method the amount of heat necessary to raise a unit of water 1° C. is termed a calorie. The heating-power of air-dry wood is given as equivalent to 3,620 calories, charcoal at 8,080 calories. Hence one kilogram of wood or charcoal will raise the temperature of 3,620 or 8,080 litres of water by 1° C.

The latest results by Bersch * are as follows :—

| | Heat-units. |
|---|-------------|
| Charcoal | 7,000 |
| Half-charred (red) ditto | 3,980 |
| Absolutely dry wood | 3,600 |
| Wood containing 20 per cent. of water ... | 2,800 |
| Limewood „ „ „ | 2,700 |
| Maple „ „ „ | 3,600 |
| Poplar „ „ „ | 3,500 |
| Beech „ „ „ | 3,500 |
| Spruce „ „ „ | 3,250 |
| Ash „ „ „ | 3,200 |
| Hornbeam „ „ „ | 3,100 |
| Oak „ „ „ | 2,700 |

The heating-effect reckoned in calories, depending on weight, shows that there is little difference in the heating-power of the different woods. But as in commerce wood is dealt with by volume and not by weight, only statements giving the heating-effect according to the volume of wood consumed, that is termed the **specific-heat effect**, are of practical importance.

The following tabular statement gives the specific-heat effects of wood as compared with that of pure carbon (100) :—

SPECIFIC-HEAT EFFECTS.

| Species of Wood. | Specific air-dry Weight. | Specific-heat effect. |
|---------------------------|--------------------------|-----------------------|
| Hornbeam | 80 | 28 |
| Oak | 76 | 26 |
| Ash and beech | 74 and 72 | 24 |
| Maple | 70 | 23 |
| Birch | 60 | 23 |
| Scots pine | 52 | 20 |
| Silver-fir and spruce ... | 47 and 46 | 19 |

* Bersch, "Die Verwertung des Holzes auf chemischen Weg." Wien, 1893.

SPECIFIC-HEAT EFFECTS—*continued.*

| Species of Wood. | Specific air-dry Weight. | Specific-heat effect. |
|------------------|--------------------------|-----------------------|
| Lime | 52 | 18 |
| Poplar | 45 | 14 |
| Peat... .. | | 35 |
| Lignite | | 77 |
| Charcoal | | 96 |
| Carbon | | 100 |

The third or **economic method** for determining heating-power resembles that in which wood is burned in the ordinary manner.

Equal volumes of different woods are burned in a stove or furnace, the heat of which is shown by means of a thermometer, or by a steam-engine the steam from which is measured by a manometer. This method shows that in order to burn wood in our ordinary stoves, so much air is required to keep up the burning, that half the heating-effect is lost by the draught up the chimney.

The scale given above shows that **specific weight** is the chief factor in heating-power, so that the heaviest wood in a tree, or of different species of trees, gives the greatest heat. Only in the case of woods of nearly the same specific weights do other factors intervene. The measures detailed on page 58 to produce heavy wood also ensure good heating-power, as **specific weight and heating-power correspond.**

As **lignin** is richer in carbon than cellulose, every factor that increases the lignin in wood also increases its heating-power (*cf.* p. 79).

The **water** contained in wood, as in sapwood, may attain 50 per cent. of the weight of the wood; then 45 per cent. of the heating-power is used to drive off the water as steam and only a small percentage remains for heating the stove.

As regards **float**ed and **raft**ed wood the same considerations apply that have been already described (p. 102). They are especially liable to be attacked by fungi, chiefly species of *Corticium*. A special investigation of the fungi that attack floated wood is desirable.

Nothing reduces the heating-power of wood more than the

growth of fungi, which destroy the cell-contents and the walls of the woody tissues. Decaying wood has little heating-power, while rotten wood merely glows without any flame.

Ethereal oils rich in carbon, such as turpentine, increase the heating-power of wood. In the case of pieces of wood that have nearly equal specific weights, their possible contents in resin is decisive as to their greater or less heating-power. The excellent book by Hempel and Wilhelm* gives the following heating-powers for conifers, that of beech being 100, and confirms this statement for spruce and silver-fir :—

| Species. | Contents in Grains of Resin per kilogramme of Wood (Mayr) † | Specific Weight. | Heating-Power. |
|-------------------|---|------------------|----------------|
| Austrian pine ... | — | 67 | 86 |
| Larch ... | 32 | 60 | 82 |
| Scots pine ... | 42·38 | 52 | 77 |
| Spruce ... | 16·01 | 47 | 76 |
| Silver-fir ... | 8·34 | 46 | 67 |
| Weymouth pine ... | 48·79 | 40 | 50 |

Abnormal contents of resin, as at wounds and in the stump-wood of pines, increases the heating-power. Such wood is used for torches. [Stump-wood of the longleaved pine, in the Himalayas, also used for torches, is sometimes resinous enough to be translucent.—Tr.]

Betulin increases the heating-power of the wood and bark of the birch. When birch is cut into small pieces it gives out heat rapidly, but the heat is not durable. Split birchwood is much used by bakers.

In utilizing the heat from wood there is much difference in the various species. Woods which crackle and emit sparks when burning, and most soft woods, rapidly develop an intense heat of short duration. Such are larch, spruce, silver-fir, peeled coppice oak, sweet-chestnut [also young pinewood and broadleaved softwoods; these woods are used in bakers' ovens and for pottery and glass-making.—Tr.] Woods which burn slowly and quietly with glowing embers produce eventu-

* G. Hempel u. R. Wilhelm, "Die Bäume u. Sträucher des Waldes." Wien, 1900.

† "Das Harz der Nadelhölzer." Berlin, 1894.

ally the greatest heat, and are favourite woods for heating houses. Such are the woods of beech and hornbeam, olive-wood, also that of evergreen oak. Finally, woods rich in resin, such as torchwood and older pinewood of all species, burn with long flames, but do not consume their carbon completely, and give out much smoke and soot. Such wood is excellent for steam-engines.

Silver-fir twigs and needles are so rich in turpentine that they will burn when freshly cut. Larchwood is a bad combustible. Julius Cæsar calls it "*lignum igni impenetrabile.*"

7. *Aptitude of Woods for being Worked.*

a. By Implements.

The reaction of wood to cutting implements, such as the chisel, axe and plane, depend on the direction in which the force is used, and cutting is most difficult perpendicular to its fibres, while cutting becomes easier the nearer the direction of the force is to their direction, because their splitting assists cutting. Hence with the axe it is easiest to cut obliquely. In the case of softwood the fibres bend before the axe, and heavy axes are required, which have more momentum and penetration than light axes. For hardwoods lighter axes are usual, as the fibres do not bend before the axe.

The knife hardly deserves mention as a forest tool, but, when used with the hand, its action unites that of the axe and saw more than that of any other tool; it affords, therefore, a suitable test for classifying the degrees of hardness of woods approximately.

Nördlinger, from average results obtained with different tools, gives the following classification of woods according to their hardness:—

Hard as bone: Barberry, box, privet, lilac.

Very hard: Common dogwood (*Cornus sanguinea*, L), yellow dogwood (*C. Mas*, L.), whitehorn, blackthorn.

Hard: Robinia, field-maple, sycamore, hornbeam, wild cherry, service-tree, buckthorn, elder, yew, pedunculate oak, mahogany.

Fairly hard: Ash, holly, mulberry, mountain - pine,

plane, quince, Turkey-oak, elm, beech, sessile oak, sweet chestnut.

Soft: Spruce, silver-fir, horse-chestnut, black alder, white alder, birch, hazel, juniper, larch, black pine, Scots pine, bird-cherry, sallow.

Very soft: Paulownia, Weymouth-pine, poplars, aspen, most willows, lime.

[Great attention is paid in France to the cultivation of oak, and Mathey's remarks on the different qualities of oakwood as grown as standards over coppice or in high forest are very appropriate here. The French distinguish *bois-maigre* from *bois-gras*. The former contains a large percentage of summer-wood in the annual zones, and is hard and horny, the wood, chiefly of pedunculate oak grown as standards, is dense, hard, and elastic, though subject to warp and crack. Such wood is particularly suitable for constructing buildings, ships or barges. Sawn oakwood of this quality when once seasoned is unrivalled for durability and beauty.

The softer *bois-gras* has less summer-wood, so that the percentage of porous spring-wood is often equal or superior to that of the harder summer-wood. Such wood splits and breaks easily. Sessile oaks grown on rocky ground in dense high forest yield soft wood. Such wood is not strong, but is easy to work and yields excellent wood when split or sawn, especially when the silver-grain is exposed, it is suitable chiefly for indoor usage.

Mathey remarks that calcareous soils, which produce soft oak timber, usually yield the best beech, in which whiteness and fineness of grain are the chief factors of good quality. Ash yields its best and most elastic timber on moist quaternary alluvium, and its most brittle timber on dry oolitic soils. That produced at the junction between the oolitic and lias clay, where there are numerous springs, is of intermediate quality. The best ashwood is produced in Britain.

In France, in the case of coniferous wood, altitudes below 1,600 feet yield soft, rapidly grown wood, with annual zones of 15—20 mm. Above this altitude the annual zones gradually diminish to 3—6 mm., and the wood is hard, elastic and well lignified, with a large percentage of summer-wood. Near the

limits of arborescent vegetation the wood has annual zones less than 3 mm.; it is light and soft, but extremely regular in growth, and yields timber that is best for carving or for musical instruments.—Tr.]

It stands to reason that **hardness** is an obstacle to cutting, and as hardness has already been shown to depend on specific weight, the scale of specific weights (p. 64) affords a scale of hardness.

Moisture in wood facilitates the work of cutting **hardwoods**, but in **softwoods** it renders it more difficult (*cf.* p. 48).

Toughness heightens the labour, but **softness** assists it. The soft, unelastic wood of Weymouth-pine is easy and smooth to work; in this it surpasses all the other *Abietineae*. Only species of *Chamaecyparis* have similar soft and unelastic wood, and therefore are esteemed highly by joiners and cabinet-makers abroad.

Regularity in the structure of the annual zones, straightness of bole and vertical direction of the fibres are favourable conditions for the easy working of wood by cutting implements. All knots, wavy or twisted fibres, or burrs increase the labour of cutting and planing, often more than does the extent of surface of the wood, for the chisel cuts irregularly into such wood, and the plane has constantly to be turned round while planing unevenly grained wood.

The resistance wood offers to a **saw** differs considerably from that offered to cutting implements. The edges of the teeth are **set** in two parallel lines, each tooth with one or two cutting edges according to the nature of the saw. The teeth first scratch the fibres slightly, the second stroke penetrating more deeply and tearing from its basis the wood left between the two scratches made by the first stroke. Sawing is easiest across the fibres of the wood, when the saw is applied first to a radial section; it is more difficult when a tangential section is attacked, but most difficult of all in the direction of the fibres, as when planks are sawn out of a log. The teeth must then cut, more or less, through the whole length of each fibre that it meets, instead of merely across the fibres (as with a cross-cut saw), and must also tear adjacent fibres apart. For such work, large teeth with a wide set are necessary.

In broadleaved wood the softer and longer the fibres and the looser the texture of the wood, the greater the difficulty of sawing; the section then becomes rough and much sawdust is produced, indicating difficulty in the work. Sawing is easier for dense short-fibred wood, and smooth cuts with little sawdust result. It is therefore easier to saw hard broadleaved wood than soft broadleaved wood. Coniferous wood is the most easily sawn, on account of its simple anatomical structure and fine medullary rays.

Moisture diminishes the hardness of wood, but increases the pliability of its fibres. In the case of hardwoods this increase of pliability is not great, and for most conifers does not appear to counterbalance the advantage of the softness of the moist fibres. Hence, pine, larch and spruce woods are more easily sawn green than dry; but in the case of certain soft-fibred, loosely textured woods, the pliability of the fibres counterbalances the advantage of moisture, as for instance in poplar, aspen, birch, willow, etc., the timber of which is generally easier to saw dry than green.

If we take the resistance to the saw across the fibres offered by beechwood as 1, Gayer's own experiments in the case of freshly felled wood give the following results:—

| | Resistance to saw. |
|--|--------------------|
| Scots pine, silver-fir, spruce | = 0·50—0·60 |
| Maple, larch, alder | = 0·75—0·90 |
| Beech | = 1·00 |
| Oak | = 1·03 |
| Sallow, aspen and birch | = 1·30—1·40 |
| Lime, willow and poplar | = 1·80 |

With augurs and other tools used for boring wood, which both split and cut, the work is easiest when commenced on a tangential section of the wood and therefore the boring is radial. Boring from a tangential section is more difficult, and from a transverse section most difficult. Screws act like augurs.

Nails are driven into wood most easily from the transverse section, but then hold badly. It is difficult to drive nails into wood that is coarse-grained, but as they then hold well and the wood has no tendency to split, such wood, *e.g.*, elm-wood, is often preferred for packing-cases or boxes for tin-plates, etc.

b. Aptitude of Wood for being Ground into Pulp.

When wood is to be ground into pulp for paper-making, etc., if its transverse section is placed against the rotating stone, the resulting triturated wood is like meal; if the longitudinal surface be turned to the stone, the ground material is too coarse for paper-making. A suitable length of fibres for paper is produced when the pith of the wood is at an angle of 45 to 50 degrees to the rotating stone. Softwoods are easier to grind than hardwoods, they yield more pliable fibres that are more easily felted than the fibres of hardwoods. The wood of poplars, lime-trees, spruce and silver-fir are specially suitable for wood-pulp. Resinous, brittle pinewood is less suitable. Heavy hardwoods are useless for this purpose. Any want of uniformity in the direction of the fibres, or in hardness or colour, reduces the value of the wood. Wet wood yields long fibres; unsound wood is useless.

c. Aptitude of Wood for being Polished.

Moderately heavy and moderately hard woods are the best for polishing; it is more difficult to make a smooth surface on very hard and soft woods. The radial and tangential sections are the easiest to polish. Woods with large medullary rays are polished less easily than those with fine rays. Large vessels evenly distributed that absorb much polish imply wood that can be well polished, especially when the wood has a natural lustre. Mahogany, rosewood, satinwood, and the woods of ash, walnut, olive, pear, box, almond, pistachio and maple, polish well; oak, mulberry and cherry and most other broadleaved woods are less suitable, while conifers (except yew and rootstock of *Callitris quadrivalvis**) that have no vessels, can be polished only with difficulty and unsatisfactorily.

d. Wood-bleaching

In wood-bleaching † the tannin, resin, etc. are removed from wood by boiling it in a solution of potash or soda, and it is then

* Mathey, who states that this N. African wood is very beautiful.

† Mellmann, "Lehrbuch des Beizens, Bleichens, Polizierens u. Lackierens der Hölzer." Berlin, 1899.

bleached by calcium-chloride or by hydrogen-peroxide. Species of wood that are poor in tannin and resin, such as soft broad-leaved woods, are best for the purpose. It is more difficult to bleach the wood of conifers and oaks. Holly, hornbeam, and horse-chestnut are naturally the whitest of European woods.

e. Wood-staining.

All softwoods are more easily stained than are heartwoods, as the dye penetrates more deeply into their tissues. Woods with numerous small vessels are more suitable for staining than those with a few large vessels, while coniferous woods having no vessels are not so suitable. Woods with fine medullary rays are much preferred to those with large rays. Lime, pear, birch and maple are most suitable; then ash, oak, hornbeam and beech; worst of all, conifers.

f. Pyrography.

Pyrography, or poker-work, is the art of burning designs into wood with a red-hot platinum stylus, the design having been previously drawn with a lead-pencil on the wood and its lines then followed with the stylus. Evengrained wood of Cembran pine, beech, lime, maple, and pale oakwood are used.

g. Suitability of Wood for Charcoal-making.

Soft broadleaved and coniferous woods are charred more easily than hard and heavy woods. Branches are more difficult to char than stem-wood and the latter than root-wood; water in wood is an obstacle to charring. Unsound wood and wood cut into small pieces is charred easily. The loss of volume in charring heavy woods is about 45 per cent. and for light woods about 30 per cent.; in all woods there is a loss of weight, in conversion to charcoal, of 75-80 per cent., only 20 to 25 per cent. of the weight of the wood remaining as charcoal. Charcoal from hard, heavy woods has always a greater heating-power than that of soft woods, so that a scale of the best woods for charcoal-making is prepared easily.

h. Aptitude of Wood for Impregnation.

Wood is impregnated in order to increase its durability. Woods resist superficial impregnation by liquids, as they do

stains, when only boiling under ordinary atmospheric pressure is employed. If the liquid is pressed into the wood by pneumatic or hydrostatic pressure the sapwood of all woods absorb it easily and thoroughly, especially when the antiseptic liquid is pressed in through the transverse section or a hole bored in the wood, and follows the course of the fibres (Hydrostatic method.) The presence of vessels facilitates the absorption of the liquid. The heartwood, on account of its dryness, and in hardwoods because the vessels are often filled with thyloses, is less absorptive; if also the heartwood is naturally coloured it will not absorb antiseptic liquids (oak, larch, and Scots pine partly). The abnormal reddish colour in beech heartwood also prevents impregnation. The more freshly cut the wood, the more absorptive it is, but dry wood, especially of conifers, takes a longer time for the liquid to pass through the walls of the tracheids. [It is, however, the practice in Ireland to season Scots pine railway-sleepers for twelve months before creosoting them; the sleepers then last for eighteen to nineteen years, instead of for only nine years if they are creosoted immediately on arrival at the workshop. If unseasoned wood be creosoted, the external layers enclose wet heartwood. Even after being eighteen or nineteen years on the permanent way, the sleepers creosoted after seasoning are removed solely because, owing to abrasion, they become too thin ($3\frac{1}{2}$ inches); they are still serviceable for many years as fencing-posts.—Tr.]

8. *Dimensions of Trees.*

MAXIMUM HEIGHT-GROWTH.

| I. 115 to 150 feet. | II. 100 to 130 feet. | III. 65 to 80 feet. (Rarely to 100 feet.) | IV. 15 to 50 feet. (Chiefly Shrubs.) |
|---|--|--|---|
| Sequoias. Douglas fir. Deodar. Spruces. Silver-firs. Weymouth pine. Giant thuya. Lawson's cypress. Corsican pine. | Beech. Oaks. Poplars. Elms. Limes. Ash. Sweet-chestnut. Sycamore. Norway-maple. Walnut. | Horse-chestnut. Hornbeam. Birch. Aspen. Sp. of Pirus and Prunus. Tree-Willows. Robinia. Cembran pine. Cupressus macrocarpa. Cryptomeria japonica. | Mountain pine (var. uncinata) 55 feet. Common maple. Holly. Box. Laburnum. Whitethorn. Common juniper. Euonymus. |

HEIGHT-GROWTH—*continued.*

| I. 115 to 150 feet. | II. 100 to 180 feet. | III. 65 to 80 feet. (Rarely to 100 feet.) | IV. 15 to 50 feet. (Chiefly Shrubs.) |
|--|---|---|---|
| Libocedrus decurrens. Tsuga Mertensiana. (Some of these may exceed 150 feet in length.) | Tulip-tree. Austrian pine. Taxodium distichum. Pinus rigida. „ divaricata. (Banksiana.) | Yew. Pencil-cedar. Hickory. Catalpa. | Hazel. Viburnum. Cornus. Sambucus. Syringa. Blackthorn. Mountain pine (Pumilio). |

[This list differs from that given by Mayr, so as to include the economic trees and shrubs that are grown in the British Isles. Under favourable conditions certain trees may pass into a higher height-class.—Tr.]

The development of a tree in height depends on several factors; for instance, soil, climate and exposure to wind, method of production as well as species. The current height-increment attains its maximum in the pole-stage, then sinks again till maturity is reached, becoming nil in trees with eventually flat or round crowns, such as Scots pine, silver-fir, or cedar, or in trees such as ash and horse-chestnut, where the terminal shoot blossoms. Generally the height-growth is maintained longest when trees are in their optimum climate, on the most suitable soil, and grown in dense but not in the densest crops. It has often been asserted that density of growth favours height in trees, and certainly this is true in the younger stages of growth, just as removal of side-branches in fruit-tree culture favours the leading shoot of a tree. In a group of trees of the same age, the border trees are shortest, and those in the centre tallest.

Diameter-growth at first falls behind height-growth, especially in dense crops, attains its maximum somewhat later and ends with the death of a tree, for every tree forms an annual ring as long as it is alive. Only in very suppressed individual trees, a cessation of diameter-growth is alleged for the lower part of the stem; this has not yet been proved. Diameter-growth is favoured by the admission of heat and light and the consequently increased nutriment available.

9. Shape of Trees.

Every tree has three parts, the bole, roots, and crown. In youth, the roots and crown preponderate over the bole, the formation of which begins at the 15th or 20th year. By silvicultural means a forester can regulate the proportion between the bole, crown and roots of a tree. Open growth favours crown and roots at the expense of the bole; density of growth increases the bole at the expense of the crown and roots.

On good soil, the bole and crown become relatively large, the former in a less degree than the latter. Other conditions being equal, crops of trees produce more volume per acre on good soils, which favour stem-timber, though more numerous but smaller trees grow on an acre of poor soil. Usually in close, mature woods, only 10 to 20 per cent. of the volume is lop-and-top (under three inches in diameter). Individual species vary in the proportion of bole and crown in accordance with the following statement.

| I. | II. | III. |
|--|---|---|
| <p style="text-align: center;">Spruces. Larches. Douglas fir. Silver-fir.</p> <p>The stem runs up to the topmost bud of the tree and height growth, except in silver-fir, continues as long as the tree lives. The branches are small.</p> | <p style="text-align: center;">Pines. Tsugas. Cypresses.</p> <p>Length of stem depends on climate and locality. In open growth or in old age, the stem divides into several large boughs.</p> | <p>Broadleaved trees resemble pines in their growth, but stem preponderates in the following :</p> <p style="text-align: center;">Quercus palustris. Poplars. Tulip-tree. Alder. Birch. Ash. Sessile oak. Aspen.</p> <p>Also in beech and other broadleaved trees, when grown in dense crops.</p> |

The following statement is compiled from results given by Pfeil and M. Hartig, with which those given by Pressler and Burckhart have been compared. In the case of dense crops grown in high forest to an advanced age in good localities,

the percentages of bole, branch-wood and root-wood of different species are as follows:—

| Species. | Percentages. | | | Remarks. |
|----------------|--------------|-----------|--------|--|
| | Bole. | Branches. | Roots. | |
| Larch | 77—82 | 6—8 | 12—15 | [The figures given by Mayr for branches and roots are assumed to be correct, but those for the boles have been altered to correspond with them, which they do not, in Mayr's statement.—Tr.] |
| Weymouth pine | 57—86 | 5—23 | 9—20 | |
| Spruce... .. | 65—77 | 8—10 | 15—25 | |
| Scots pine ... | 65—77 | 8—15 | 15—20 | |
| Silver-fir ... | 60—77 | 8—10 | 15—30 | |
| Aspen | 80—90 | 5—10 | 5—10 | |
| Birch | 78—90 | 5—10 | 5—12 | |
| Alder | 75—80 | 8—10 | 12—15 | |
| Maples... .. | 65—75 | 10—15 | 15—20 | |
| Lime | 60—68 | 20—25 | 12—15 | |
| Beech | 55—70 | 10—20 | 20—25 | |
| Ash | 55—70 | 15—20 | 15—25 | |
| Hornbeam ... | 60—65 | 10—20 | 15—20 | |
| Oak | 50—65 | 10—20 | 15—20 | |

Standards over coppice show different percentages of bole, as they are much more branchy than high forest trees, especially when old. Lauprecht gives the following:—

| Species. | Percentage in Boles of Different Ages. | | |
|--------------|--|---------------|-----------------|
| | 50—60 Years. | 60—100 Years. | Over 100 Years. |
| Oak | 58 | 42 | 18—25 |
| Beech | 59—60 | 51 | 28—40 |
| Aspen | 40 | 40 | 25—29 |
| Birch | 35—40 | 35—44 | 34—40 |

As regards **cyllindricity of stem**, the cleaner the stem is from branches the more cylindrical it is. **Density of crop produces cylindrical boles**; open growth, conical boles. It has been asserted that the upper part of the stem is nourished better than its lower part. Metzger and Schwarz consider the better nourishment of the top of the bole as the necessary consequence of the gradual construction of the tree according to the laws of equilibrium.

A measure of cyllindricity is the **form-factor**, or the ratio

of the volume of the bole to that of a cylinder of equal height and diameter (at chest-height). Neumeister* gives the following form-factors, that of the ideal cylinder being 100:—

| Species. | Height in Meters. | Form-factor. |
|----------------------|-------------------|--------------|
| Spruce | 20 | 53 |
| " | 30 | 50 |
| " | 40 | 48 |
| Silver-fir | 20 | 54 |
| " | 30 | 50 |
| " | 40 | 44 |
| Scots pine | 20 | 47 |
| " | 30 | 48 |
| Weymouth pine | 30 | 45 |
| Beech | 20 | 49 |
| " | 30 | 49 |
| Cembra pine | 20 | 49 |
| Larch | 30 | 48 |

Straightness of Bole.—This occurs when the axis of the tree runs in a straight line. If the axis of a tree is bent in a single plane, or a branch and part of a stem have their axes in one plane, valuable curved timber, or knees, may be formed, as in oak timber for ship- or barge-building. If the tree bends so that its axis is in two or more planes, it is of little value. Conifers are usually straight; spruce, silver-fir and Douglas fir the straightest, then larch and pines. Among broadleaved trees, the cherry, poplars, alder and sessile oak are straightest, but beech grows straight in a dense wood, and a mixture of beech with oak, sycamore, ash, etc., will straighten the boles of these species in a remarkable manner.

Percentage of Heartwood.—In all trees, heartwood is formed after a certain age only, [two or three years for sweet-chestnut, so that mere coppice-shoots of this species have a large percentage of heartwood, and are very durable when used for fencing. Mulberry, robinia, laburnum and larch also produce heartwood in 3—10 years. Mathey states that in oak, when grown as standards over coppice, the

* "Forst u. Jagd Kalender," 1902.

transformation of sapwood into heartwood is somewhat as follows :—

| Age in Years. | Number of Zones. | | Thickness of Sapwood. | |
|---------------|------------------|------------|-----------------------|---------|
| | Sapwood. | Heartwood. | mm. | inches. |
| 14 | 14 | 0 | — | — |
| 17 | 11 | 6 | — | — |
| 20 | 11 | 9 | — | — |
| 27 | 10 | 17 | 22 | 0·8 |
| 50 | 10 | 40 | 23 | 0·9 |
| 65 | 12 | 53 | 32 | 1·2 |
| 80 | 13 | 67 | 31 | 1·2 |
| 95 | 14 | 81 | 31 | 1·2 |
| 130 | 14 | 116 | 21 | 0·8 |
| Older. | — | — | 21 | 0·8 |

Thus the conversion of sapwood into heartwood proceeds irregularly, and not according to the annual zones. At first the percentage of sapwood is enormous; later on the difference between the volume of new sapwood formed and that of the old sapwood transformed into heartwood steadily diminishes, until between 90 to 100 years equal volumes of heartwood and sapwood are formed annually.

Oaks with rapid growth and with smooth bark have comparatively more sapwood than slower growing trees with rough bark, and those grown on north and east slopes have more sapwood than those grown on south and west slopes. Pedunculate oaks usually have more sapwood (2—8 C.) than sessile oaks (1—5 C.).

In the case of oaks grown in high forest the conversion of sapwood into heartwood begins later, and is the earlier and the more active, the more light is given to the poles. Suppressed oaks often have no heartwood when 25 years old, while old high forest trees have more zones of sapwood (18—25) than old standards over coppice. Oaks coming from the last thinnings have little sapwood.

Stunted oaks grown on impermeable London clay at Oxshott, in Surrey, have little sapwood and produce very hard wood, suitable for gate-posts.—[Tr.]

Mayr gives the following data :—

| Breadth of Sapwood in Centimeters. | Species. |
|------------------------------------|--|
| Up to 3 | Yew, larch, oak. |
| 3—5 | Scots pine, Weymouth pine, spruce, silver-fir. |
| 5—10 | Maples, elms, ash, walnut. |
| Over 10 | Other broadleaved trees. |

As already stated, sweet-chestnut, laburnum, robinia and mulberry may be added to the first class of trees with narrow sapwood.

Freedom from branches, or cleanness of bole, is one of the most important properties of economic timber. All superincumbent boughs and foliage shade the lower and earlier formed branches and causes their death sooner or later, according to their greater or less susceptibility to shade. This natural clearance of the lower branches and foliage is effective in trees in an open position only partially and up to a certain height. Whenever not only the crown of the individual tree, but also the branches of neighbouring trees unite in giving shade, as is the case in a **dense crop**, the lower branches of shaded stems must die rapidly, so that, by a **proper density of crop**, a forester can readily obtain boles that are clean up to a desirable height. Whenever, by a thinning, a dense crop receives more light the death of lateral branches ceases.

It is therefore evident that the early crowding of a crop is desirable, and all factors that retard this, such as wide planting, are prejudicial to the quality of the produce. Attempts to remedy this by pruning are in the first place costly and the resulting produce is saleable only near large towns, whilst it is dangerous to the health of the trees. Pruning is useful as long as only dead branches are removed, but when living branches, especially over 2—3 inches in diameter, are pruned away, either callus growth covers the wound and affects the quality of the wood injuriously, or fungi and insects attack the wounds, while desiccation by the sun and moisture from the air increase the damage greatly. In broadleaved woods epicormic shoots that require fresh pruning may spring from the edges of the wounds.

10. *Yield of the Chief Species.*

Regarding the yield per acre in solid cubic feet of the principal species of North European trees, the following statement has been compiled from data given by v. Baur, v. Lovey, Kunzi, Schuberg, Schwappach and Weise. Quarter-girth volumes are $\frac{1}{4}$ ths of those given, or approximately one quarter less* :—

| Species. | 80 Years. | | | | 100 Years. | | | | 120 Years. | | | |
|----------------|-----------|-------|-------|-------|------------|--------|-------|-------|------------|--------|--------|-------|
| | I. | II. | III. | IV. | I. | II. | III. | IV. | I. | II. | III. | IV. |
| Spruce... | 11,760 | 9,030 | 6,720 | 4,760 | 14,000 | 11,200 | 8,680 | 5,300 | 15,680 | 12,880 | 9,940 | 7,280 |
| Silver-fir | 10,150 | 7,490 | 5,740 | 4,060 | 14,000 | 11,200 | 8,680 | 5,300 | 16,660 | 13,720 | 10,710 | 7,700 |
| Beech ... | 7,280 | 5,600 | 4,200 | 3,290 | 8,260 | 5,300 | 4,830 | — | 8,890 | 6,790 | 5,150 | — |
| Scots pine ... | 6,860 | 5,600 | 4,480 | 5,060 | 8,540 | 7,140 | 5,810 | 4,270 | 10,080 | 8,540 | 6,860 | — |

These figures are for pure crops ; for mixed crops measurements are not available, and averages taken from the above figures will not give true results, as a soil that is of one quality for any species may be of different quality for another species, owing to their different requirements in soil, climate, number of trees, etc. As regards the produce of thinnings, figures are available for pure crops, but they are rapidly losing their value, as new methods of thinning are coming into vogue.

E. DEFECTS IN WOOD.

1. *Defective Structure.*(a) *Abnormal Tissues.*

Abnormal parenchyma (callus) covering wounds, with intermediate tissues eventually passing into ordinary wood, may be termed **occluding tissue**. Whenever the bark of a tree is crushed or removed by any injury—such as beating it to shake down fruit (chestnuts, etc.); cutting in it names or figures; abrasure by cart-wheels, falling trees, climbing-irons

* For a detailed account of the yield of the different species of European trees, cf. Schlich's "Manual of Forestry," vol. iii., "Forest Management," 3rd ed., 1908.

(Fig. 45) (to obtain cones, birds-nests, or to prune the tree); or by exposure to the sun (sun-blister), hail, lightning, etc.—the injured cambium and wood is killed, while from the surrounding healthy cambium and the parenchyma of the wood and cortex, an occluding callus is formed, the abnormal fibre-direction of which causes the wood to deteriorate.

Pith-flecks are small occluding tissues that have closed old wounds in wood. Such pith-flecks are common in the wood of birch, alder and species of *Prunus* and *Pirus*: as they have a

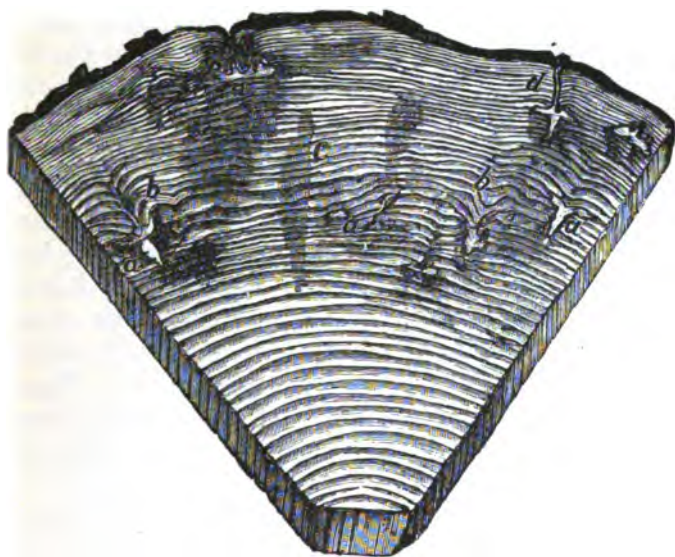

Fig. 45.—Injuries in Scots pinewood caused by climbing-irons.

pathological origin, and may be absent, they should not be used in the identification of these woods. [Stone, op. cit., states that they are due to short peripheral galleries made by larvæ, which are afterwards filled by parenchyma.—Tr.]

Resin-galls (Fig. 46) are flattish hollows within an annual zone of coniferous wood filled with rosin and vary from an insignificant size to the length of one's hand. When large and numerous they have a prejudicial effect on wood and may be so numerous as to render the wood unsuitable for planks, laths, etc.

The cause of resin-galls is explained by Mayr* as an

* H. Mayr, "Das Harz der Nadelhölzer." 1894.

outpouring of resin into the cambium zone in early spring after only a few spring cells of wood had been formed, the mass of resin was isolated by occluding tissue. Tschirch suggested that this is due to a wound, but if so, why, always at a definite season of the year and near the crown of the tree



Fig. 46. — Longitudinal section through a resin-gall in spruce-wood. Occluding tissue in little semi-circular groups of cells protruding into the hollow filled with resin. The external zones are convex.

as well as low down the stem? The wound may, however, be caused by an insect. The prevalent opinion that resin-galls are due to a conversion of the cell-walls into resin has been proved by Mayr to be wrong. Resin-galls occur in coniferous woods that have resin-ducts, spruces, pines, larches and Douglas-fir; as they are pathological, nothing can be decided about the identity of woods by their absence, but if present they distinctly prove that the wood is not that of silver-firs, tsugas or cypresses. The wood of the latter trees, however, sometimes has rudimentary resin-ducts, especially on wood occluding wounds caused by hail or frost. In wood with resin-ducts there may be

abnormal numbers of them in certain decades and in others only a few.

Gall-parenchyma, especially in broadleaved trees is produced by the stimulation of insects and their larvæ. Species of *Lachnus*, a kind of aphid, form a gall on forest plants in which all stages of occluding tissue, from parenchyma to wood-tissue, occur.

Abnormal cell-formations resembling occluding tissue are caused by late frost in both broadleaved and coniferous wood. Damage done by late frost to the cambium is often accompanied, in lengthening shoots, by a bending of the shoot

either spiral or like a bow, and this is visible externally. Damage to shoots in their second or third year is not externally visible. If a frost comes in June, the injured brown wood is joined to the same year's spring-zone of wood by a callus and is followed by subsequent frost-cankers. To an observer without a magnifying glass this might appear to be a double annual ring*. Mayr has noticed such frost-rings since 1890 and in Fig. 12 *a, b* and Fig. 22, drawn from nature, purposely has represented some apparent double rings, but their origin has not been yet explained.

A true double ring occurs only when there are two spring-zones and two summer-zones in an annual zone, in the order, early-wood, late-wood, early-wood, late-wood. This is very rare in forests, but is frequent in towns, where the hot weather and an insufficient water-supply to the roots often cause defoliation at the beginning of August and the growth terminates with late-wood. Then leaves reappear and sometimes flowers; spring-wood is formed and passes into summer-wood at the end of September or in October, at the second leaf-fall

Hence the formation of spring-wood without a second summer-wood is no double ring, but a reduplication of spring-wood only, when shortly after early spring the tree loses its foliage by frosts, insects, fire, etc., and produces fresh leaves.

If there is no loss of foliage, but a second crop of leaves appear, especially in oaks when lammas-shoots are produced, or late shoots in September in vigorous young plants, or 2—4 series of shoots owing to lopping hedges and shrubs, no irregularity is visible in the wood.

If the anatomical structure of stem-wood is considered *normal*, the wood on the lower side of boughs with very thick cell-walls is *abnormal*, and so is the root-wood with its very thin-walled cells. The wood of suppressed stems with narrow annual zones is also abnormal and so is the wood of trees with very large zones grown in rich garden-soil. Wood with very thick, folded cell-walls, as on the lower side of boughs, on the eastern side of the root-stock, or on the lower side of

* R. Hartig, "Doppelringe als Folge von Spätfrost." Forst Nat. Zeitung, 1895.

obliquely inclined stems was in 1896 termed **red-wood** by Mer. Schwarz earlier than this had termed extremely hard wood "Druckholz," **tension-wood**. The name "red-wood" is unsatisfactory, as this abnormality is not due to colouring matter but to the great accumulation of lignin. Abnormally thick cell-walls are red for the same reason that ice is blue.

[H. J. Elwes in a paper read before the Surveyors' Institution in 1904,* drew attention to a form of oakwood known as "Brown Oak," which is extremely valuable and is used for the internal decoration of houses and for heavy furniture. The sapwood of these oaks is normal in colour, but the dark heartwood occurs throughout the stem, and branches whenever the latter are sufficiently thick to contain heartwood. A group of young oaks were felled in Essex, not more than 12 to 18 inches in diameter, all perfectly sound and the heartwood of a rich brown colour. Woodmen in Essex consider that trees, which retain their leaves longest in winter, have "red wood," the local name for brown oak. Some of the most valuable brown oaks grew in Rockingham Park, in Northamptonshire, and the junction of oolitic rock bearing iron-stone bands, with lias clay, appears to be favourable for this variety. Often brown oak is due to internal decay in the bole of a tree, but sometimes it is quite sound. Owing to the great beauty and value of brown oak, it is advisable that experiments should be made to determine, whether this quality is hereditary, and what conditions of soil and locality favour it. Apparently it is not known on the Continent.

The stump-wood of *Erica arborea*, called briar-wood from the French *bruyère*, forms large masses of wood that is heavy and with contorted fibres but even-grained, of a rich reddish brown colour and easily turned and carved. It is the best of wood for pipes.—Tr.]

(b) *Abnormal Direction of Fibres.*

Every wound disturbs the course of the fibres round the occluding tissues; they are curved until several years after

* Cf. Chapter on oak in the "Trees of Great Britain and Ireland," by Elwes and Henry, 1907.

the occurrence of the wound and then resume their former direction.

Stems are very rare in which the fibres run in the same plane as the pith, so that their course is straight. A spiral torsion of the fibres, that is more or less pronounced, is the rule. Twisted wood, or rather *torse wood*, for twisting implies an external force acting on the wood, may be left-inclined, or right-inclined, *i.e.*, its direction may follow the apparent diurnal motion of the sun, or the reverse. This is without economic interest, for wood the fibres of which encircle the stem within thirty feet is useless for sawing or cleaving whether the fibres bend to the right or left; it may, however, still be used for posts, and Mathey says, for railway-sleepers.

As some wood is perfectly vertical, the theory set up by Braun and Göppert, that torsion is the result of the lengthening of the fibres as the tree becomes older, must be abandoned. The fact, that, in *torse wood* the transverse division of the mother cambium cells is usually in one direction only, *e.g.* to the right, whilst when straight-grained wood is formed, these divisions are alternately to the right and left (Hartig), is the effect only of an unknown cause.

Pines are more subject to torsion than spruces or silver-firs, Scots pine fibres always turning to the right in such cases (Mathey). Neumeister states that all horse-chestnuts (but no birches) have *torse fibre*. Torsion is common also in sweet-chestnut wood. There are certain localities, *e.g.* stony soil and sunny aspects, where *torse wood* is very common and there the price of timber is remarkably low.* Straight-grained wood is recognisable on standing trees by the vertical lines of the bark-cracks and as felled and peeled trees become dry the direction of the fibres is shown by the fine longitudinal cracks in the wood (Fig. 57, *a* and *b*).

Wavy texture forms what is known economically as **curl-wood**. It diminishes the utility of wood less than torsion.

* [Such a locality is cited by Fernandez, *op. cit.*, at Ranikhet, in the Himalayas, where he says that all the *Pinus longifolia* trees have *torse fibre*. Mathey cites Marchiennes and St. Amand, as forests where it is hereditary with oaks. Gayser states that there is a Scots pine wood near Trier, where 84 per cent. of the trees are *torse*.—Tr.]

A slight waviness of fibre is very common and affects the quality of the wood but slightly. The shorter and more curved the bends of the fibres, the more the utility of the wood for cleaving is impaired. Its value for planks is increased by the beauty of its structure, which may form highly ornamental wood, as when sawn into planks alternate layers of fibres run in different directions and reflect light differently. The



Fig. 47.—Ash-wood with wavy fibres. Curl-wood.

ripples may be in the tangential section of the wood, as in Fig. 47, or in the radial section, when the wood is termed commercially "hazel," as "hazel-spruce" or hazel-oak. On the upper side of a junction of a branch with the stem, or near the roots, the wood is always wavy, this being more marked in broadleaved trees. [The ripples of fibres are normal in satin-wood (*Xanthoxylum* from the West Indies and *Chloroxylon Swietenia* from Ceylon),

so that the wood on longitudinal sections has always alternate bands of brighter or duller lustre, according to the direction in which the fibres are cut. The medullary rays also undulate. This beautiful wood is extensively used for the backs of brushes.—Tr.]

Mottled wood results from the shoots from dormant buds, which remain alive for years at the level of the outer bark ;

in trees placed in a free position after being in a dense crop, or affected by wounds, disease, or pollarding, they may develop into (epicormic) branches. In such mottled wood the main stem need not exhibit any bushy external growth from the dormant buds, and its condition may be recognisable only by reason of the irregularity of the bark cracks, or by the scales of bark being small. Such wood is very inferior for planks and cloven ware, but its beautiful structure renders its sale-price very high.

Mottled wood may occur in **all species of trees**, even

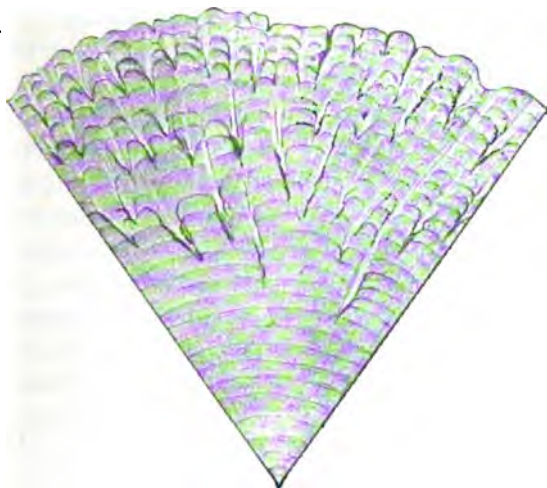

Fig. 48.—Transverse section of birch mottled wood with numerous dormant shoots. This is commercially termed Swedish "lily-wood."

conifers (Figs. 48 and 49); it may be due to alternations of colour (p. 146).

Bird's-eye maple is one of the most valuable forms of mottled wood; it occurs in all species of maple, and is specially beautiful and common in that of the sugar-maple (*Acer saccharinum*) (Fig. 49). Bird's-eye oak-wood from pollard trees is often extremely beautiful and valuable.

If the dormant shoots bifurcate and grow individually in thickness in concentric layers, large knotty swellings are formed, often of considerable size; they are termed **Burrs**. In small pieces such mottled wood, *e.g.*, in walnut, birch and alder, is valuable and in common use for small articles,

brackets, etc. Large burrs are generally unsound internally, and are then less valuable than the smaller ones; they often bear epicormic twigs.

[Mathey states that burrs from *Corylus colurna*, the tree-hazel of the Levant and Himalayas, are much used by cabinet-makers, and so were excrescences on the rootstock



Fig. 49.—Bird's-eye maple. From the sugar-maple. The bird's eyes are shown as transverse sections of the dormant shoots. The lower part of the plate is a radial section, shown lengthwise.

of *Callitris quadrivalvis*, in Algiers. These latter burrs are produced by grazing and fires, and were highly prized for their beauty by cabinet-makers, but as they have become extremely rare and it is desired to preserve the tree, they are no longer obtainable; probably the origin of the Levant hazel burrs is due to similar bad usage. Sometimes, as in beech, the dormant buds are separated from the pith by the woody growth, but grow in the living cortex, and form little round excrescences, projecting from the bark, being termed **sphaeroblasts**. They are quite useless.

The reason for the formation of burrs on trees is said by Mayr to be unknown. Evidently in many cases they are due to injuries when the trees were young, so that dormant buds low down the stem grew at the expense of the latter, and not being able to develop into ordinary branches owing to repeated injuries, or to their position deprived of sufficient light low down on the stem, they produced masses of contorted tissue.

A fungus (*Dothiora sphaeroides*) growing on ash saplings, both sædlings and coppice-shoots, sometimes attacks their

buds and destroys their leading shoots and branches, but lives on at the points of attack, forming globular swellings in the wood that are quite sound, until the sporophores of the fungus break out and convert the swelling into a canker. These knobbed saplings form valuable walking-sticks and umbrella-handles. Similar knobs appear on oak and sweet-chestnut saplings and are very common in oak coppices on the Bagshot sands in Surrey.—Tr.]

Damage by fungi, as in witches' broom, cause abnormal swellings in wood, which usually are unsound and detract greatly from its value. Mistleto also (Fig. 50) causes an abnormal swelling, and eventually wood full of holes on the trees which it attacks, preferably apple-trees, poplars, lime, silver-fir and white-thorn. These cankers, etc., are described fully in Vol. IV. of this Manual on Forest Protection.

Swellings are produced artificially by pruning saplings of dogwood, whitethorn, ash and oak, etc., in order to form walking-sticks and umbrella-handles; mottled wood also

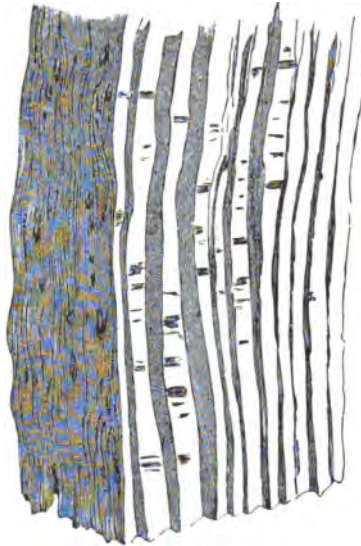

Fig. 50.—Silver-fir wood injured by mistleto. The haustoria of the latter resemble medullary rays, in the tangential and radial sections of the wood.

by lopping ash-trees. More experience is required as to the possibility of producing healthy burrs artificially.

Knottiness of Wood.—The branching of a tree begins by the budding of the pith of its leading shoot. Every subaerial or subterranean branch (except adventitious shoots) is connected by its pith with that of the leading shoot. In conifers the branches are more or less in verticils, so that the distance between two adjacent verticils gives the year's height-growth, and the number of verticils gives the age of the tree down

to a certain distance near the ground; the age of the base of the tree, where the verticils are obliterated by the bark, can easily be estimated. The true base of the year's shoot, where the pith divides, is in young stems higher and in old stems lower (on account of the obliquely ascending branches) than the apparent external position of the verticils: *cf.* Fig. 51, where *M* is the pith; after the wood has thickened up to 4, the external position of the verticil is above the true base of the leading shoot. In most broadleaved trees, except

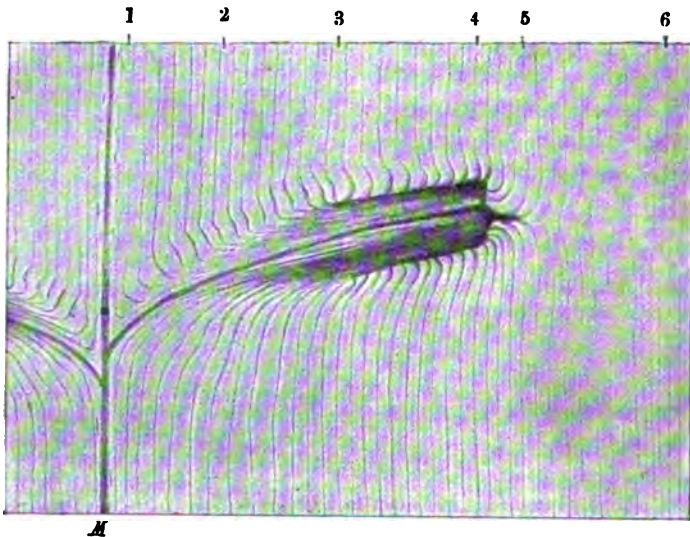

Fig. 51.—Longitudinal section through a coniferous stem and branch. *M*, pith. The darker the branch-wood the more rotten it is.

in cherry, the branches of which are sub-verticillate like those of a silver-fir, the ramification is irregular and usually the age can be determined only by counting the annual rings.

The annual zones of wood that thicken the stem and branch are firmly connected until the branch dies, as those at the base of the branch bend and unite at one end with the vertical zones of the stem, and at the other end with the obliquely ascending or horizontal zones of the branch (Figs. 51—53). The thicker the branch becomes, the more the stem-fibres are curved and the greater the disturbance

in the normal course of the stem-fibres at the junction of the branch with the stem. The properties of wood that depend on straightness of fibres are thus impaired.

When the branch dies its base is still nourished for several years and a callus is formed around it, as is the case with any foreign body in the stem, such as a nail. The longer

the interval before the dead branch falls from the tree, the longer is the base of the dead branch surrounded by occluding tissue. The swelling of the wood (between 3 and 4, Fig. 51), causes a circular depression of the bark round the dead branch, which remains moist for a long time and hastens its decomposition. At length the branch breaks off and falls, owing to its weight acting as by a lever on its rotten base. If this lever is shortened, *e.g.*, by men break-

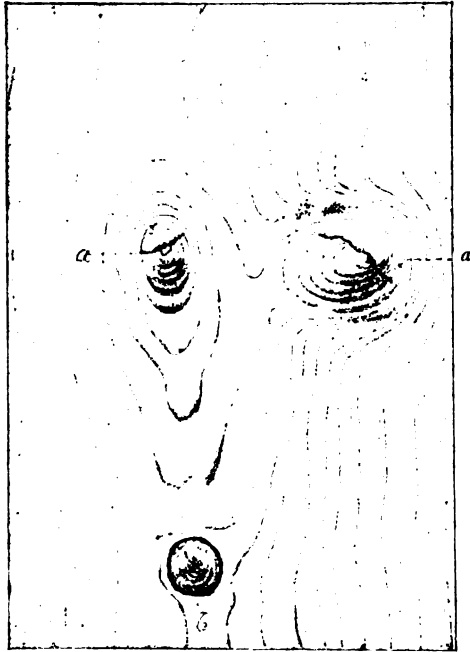

Fig. 52. — Tangential section through a verticil of a conifer. The knots, *a a*, firmly connected with the wood, showing the beauty of such wood; *b*, a small intermediate knot that will fall out when the plank is dry.

ing off dead branches for firewood, a stump or snag remains, all of which becomes occluded gradually, to the deterioration of the timber. The earlier this breakage of branches begins in a crop of trees, the more knotty and inferior is the timber it produces.

If a plank be taken from the region 1—3 (Fig. 51) of the stem it includes the hard enclosed wood of the branch, which, being specifically heavier than that of the stem, is liable to warp and crack (Fig. 52 *a*). If the saw cuts between 3 and 4 (Fig. 51),

the planks contains the dead knot, which has no fibrous connection with the stem-wood; the heavier, well-nourished stem-wood then contracts, and the knot becomes loose and falls from the plank (Figs. 52 *b* and 53). It is obvious that such conditions reduce greatly the value of the planks.

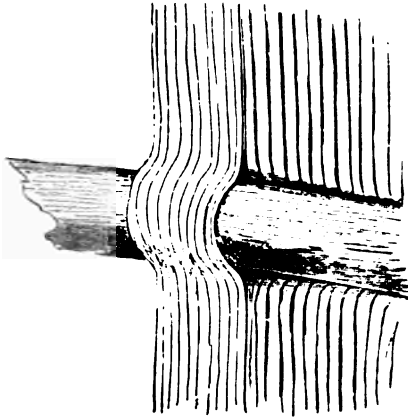

Fig. 53.— Dead branch enclosed in coniferous wood, causing a loose knot.

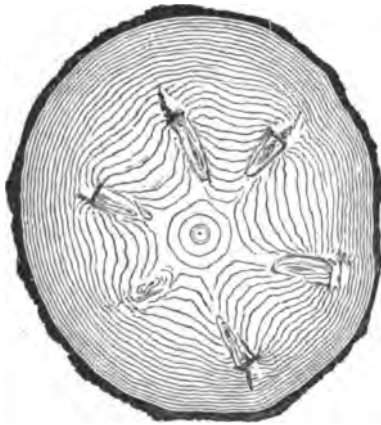

Fig. 54.— Transverse section of a stem, the branches of which have been pruned early. The external wood is faultless.

Knots that are firmly connected with the wood, dark red in colour and translucent in sunlight, render the wood valuable for certain purposes (wainscotting), especially in larch, Cembran and Scots pine.

If the branches are removed when young, only the central part of the mature stem is knotty; the resulting knottiness is so much less, the denser the crop when young and the smaller the knots.

This is the reason why the outer even-fibred wood of old trees is excellent for sawing and cleaving (Fig. 54). The evil of too early thinnings, owing to the consequent maintenance of branches which form large knots in the wood is also obvious.

Double or multiple heartwood—This occurs when a tree has two or more leading shoots, which grow up together and eventually form one stem (Fig. 56), or when by multiple-planting, or excess of natural regeneration, two or more plants

coalesce eventually into a single stem (Fig. 55). As a rule one of the stems grows slowly and eventually dies. One of the double leaders should be removed in cleaning the young plantation, but if previously it has been overlooked it should be removed in the thinnings. If not removed before it is about four inches in diameter, then, in the case of conifers, owing to slow occlusion decay will certainly affect the wood and will infect the remaining stems also. If no leaders are removed, their united bole becomes a breeding-place for insects. Even if one of the leaders is removed the remaining stem will, when mature, be swollen at the base and probably unsound. It is therefore best to remove the plant entirely, in the case of conifers.



Fig. 55.—Lower part of an old stem. Its swollen base denotes either double heart-wood or red-rot.



Fig. 56.—Union of three leaders into one stem, while two other branches have also coalesced with the main stem.

In young plants, double leaders often result from injuries to their original leading shoots by game, and less frequently from those by insects or fungi; also to the destruction of the terminal bud by birds, hail, wind or late frost. As plants are specially liable to these dangers in

clear-cuttings with subsequent planting or sowing, merchants prefer wood from naturally regenerated crops.

(c) *Defects in Sound Wood.*

Heart-shake occurs when radial cracks extend from the pith outwards; they are visible on the transverse section soon after the tree is felled. In conifers the heartwood of which contains only sufficient water to saturate the cell-walls, heart-shake is

seen as soon as the tree is felled, for the heat caused by friction of the saw dries the wood so as to cause a fine crack through the pith, which exposure to the air soon opens more widely. (Fig. 57 *a*). Where there are several such cracks, the defect is termed star-shake, and simple heart-shake, when there is only one; in the latter case, by sawing parallel to the crack, excellent planks may be produced.

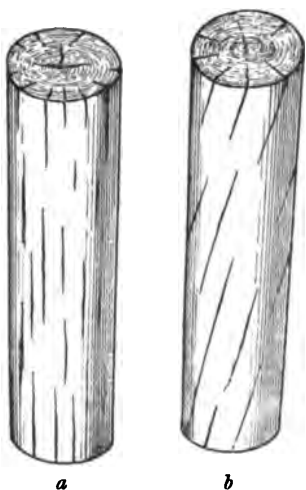

Fig. 57.—(*a*) Straight-fibred stem with air-cracks on its surface and heart-shake on its transverse section. (*b*) Torse-fibred stem, ditto, also with wind-shake on its transverse section.

Air-cracks are due also to shrinkage; they appear parallel to the course of the fibres on the surface of stems that have been stripped of their bark (Fig. 57, *a* and *b*); if the wood is rapidly dried, these cracks may penetrate deeply into the stem and reduce

the value of the wood for planks, etc. The methods of combating this defect are discussed in Part V., B.

Wind-shake occurs usually in trees that have been given an open position late in life, such as mother trees destined for natural regeneration. When trees suddenly isolated are blown about by the wind, which the harder tissues of trees that have always stood in the open can resist better, and the fibres of the wood separate along an annual ring forming arc-like shakes (Fig. 57 *b*), it is chiefly the base of the stem, up to a height of 3 to 6 feet, that is exposed to these cracks, owing to the long

lever of the bole between it and the crown of the tree. They occur chiefly on the eastern side of the stem, are less frequent on its western side, but hardly ever appear on its northern or southern sides, as storms rarely come from these directions. In very exposed localities, besides the tangential cracks, there may be a radial crack running through the pith (Fig. 57 *b*).

Wind-shakes are more frequent when the centre of an affected stem has very narrow-grained wood. Trees in selection forests, which have stood long in the shade as poles with very narrow zones of wood, begin abruptly to produce broad zones when the shade is removed, so that at the margin of the narrow and broad zones the circumferential cohesion of the fibres is weak, and the resistance to bending strains differs in the two kinds of wood.

Cup-shakes in the heartwood of trees resemble wind-shakes in appearance, but originate in a different way, being due to injuries received when the tree was young. A portion of the bark of the stem or root-stock of a sapling or pole may be abraded by deer or squirrels (larch) by resin-tapping, contact with wheels or with falling trees, etc., or owing to the death of part of the cambium and bark by forest fire; this produces an occlusion, which, if the injury is slight, gives rise merely to abnormal direction of the fibres, but if a larger part of the wood is exposed, to decay of the subjacent wood. The decayed wood is not then connected with the overlying occluding tissue (Fig. 58).

Even ants starting a nest at the base of a tree affected by root-rot may, by gnawing the soft spring-wood of conifers, produce cup-shake, as in silver-fir attacked by *Fomes annosus* (cf. Vol. IV.).

Neither wind-shake nor cup-shake extend further than over a certain part of the circumference of an annual zone; if the damage should extend all round the zone,

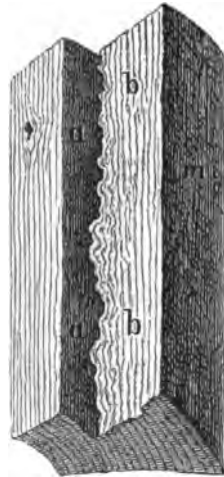

Fig. 58.—(a a) Surface peeled by deer. (b b) Wood occluding the wound and subsequent layers.

it is termed **ring-shake**, and will be described in the next section.

Frost-crack is a radial crack occurring on a standing tree at very low temperatures. This form of damage is commoner on sweet-chestnut, oaks, walnut, ash, lime, poplars, elms and maples than on conifers. Of the latter, the silver-fir suffers most and Scots pine and spruce less. It is very rare with beech and aspen.

[Turkey-oak suffers more from frost-crack than does sessile oak and the latter more than pedunculate oak, while Mathey states that *Quercus tardissima* suffers less than ordinary pedunculate oak. Fuller details about frost-crack are given in Vol. IV. —Tr.]



Fig. 59.—Frost-crack and frost-rib. The other cracks on the transverse section are due to desiccation.

R. Hartig explains the cause of frost-cracks, as follows: during frost, water leaves the cell-walls the more abundantly the lower is the temperature, until owing to the consequent drying of the wood, the latter cracks. According to Mayr, this explanation is wrong. All physical and mechanical phenomena in frozen wood, as well as Mayr's own experiments, show that water remains in the tissue walls of frozen wood. The cracking of the stem at very low temperatures (about -25°C . or -13°F .)

is due to contraction by loss of heat and this results naturally in a radial crack, for the outer layers become coldest and contract the most. When the weather becomes warmer, the crack closes, in the next growing-season the wound is occluded, but the crack opens again the next cold winter and the repetition of this cracking and occluding produces the projecting **frost-rib** (Fig. 59). Generally such stems are useless except for cleaving.

[Frost-cracks are quite common in Windsor Forest, both in oaks and sweet-chestnut trees, though the lowest temperature recorded in the open at Cooper's Hill, close to the forest and

at about the same altitude, is 10.1° F. in February, 1895. Hess gives -18° C., or 0° F., as a sufficiently low temperature for frost-crack, and it is evident that frost-crack occurs in the British Isles at temperatures considerably above -13° F. —Tr.]

Damage by lightning is fully discussed in Vol. IV., and here only some points brought forward by Mayr will be given. R. Hartig has proved that lightning strikes trees more frequently than is usually believed often causing numerous little wounds in the cambium, that are eventually occluded but become externally visible as the tree gets thicker. Conifers usually die when struck; broadleaved trees may occlude the wounds. Usually oaks, spruce, poplars, larch and pines are considered as most in danger, while beech is said to be immune. Hartig, however, has shown that young beeches are struck by lightning but that their wounds are occluded.

Usually wood struck by lightning is so completely *shaky* although only one external crack may be visible, yet so many small cracks have branched from the principal one through the wood, that when it is sawn into planks or scantling they eventually fall to pieces.

The holes made in trees by woodpeckers may be noted here (*cf.* Vol. IV.).

(d) *Diseased Wood-fibres.**

Internal disease in wood, *e.g.*, rottenness in stem, roots or branches, is discernible externally by scientific observation only. Stem-rot is merely a continuation of disease that originated in the roots or branches, or is caused by wounds, or by diseases that are visible externally, such as cankers. The earliest visible signs of disease are discolourations. As long as abnormally coloured wood is still hard it is quite utilisable, provided that by rapidly drying and using it only in dry places (interior of houses, etc.) the growth of the mycelia of the fungi and consequently the spread of decay are arrested.

* Hartig, "Lehrbüch der Baumkrankheiten," Berlin, 1901, 3rd ed.

2. Defects in the Physical Properties of Wood.

(a) Discolouration.

Any abnormal discolouration of the sapwood or heartwood usually denotes disease and the commencement of decay in wood. Many fungi may be determined specifically by the nature of these coloured stripes or specks in wood. Some abnormal colours, however, do not denote any fungoid attack, as when pale zones resembling sapwood appear in the heartwood of oaks, in the pale heartwood of suppressed stems, in cold climates or in the rootstock of several species of trees.

[In oaks the pale heartwood forming a zone 1 to 1½ inches wide in the midst of the normal heartwood and termed *mondring*, or *lunure*, on the Continent, may here be called **internal sapwood** to distinguish it from wind-shake and cup-shake, when the defect is confined to a part only of an annual zone. It is termed **ring-shake**, when the central heartwood is loose. Internal sapwood forms the subject of an important paper by Emile Mer,* from which most of the following paragraphs are taken.

Severe winter-frost may kill the cambium of a tree, in which case the tree dies. In other instances, it is found that the sapwood just inside the cambium is killed, but that the cambium is not killed, and continues to produce wood externally. In such specimens the central zones of wood have no connection with the external zones, a dark ring usually separating the dead and living wood. There is no external evidence of this **frost ring-shake**, but when the tree is felled the internal core of the wood separates at once from the external wood. Specimens of frozen wood are in the Oxford Forestry Museum and in that of the Forest of Dean, where not only the main stem of an oak, but also its branches, are in this condition, the internal wood being quite loose from the external wood in which it rests like a metallic casting in its mould. In this case no decay is discernible in either the external or internal layers of the wood.

It may, however, happen, as in the cases described by Mer,

* Boppe et Mer, "La lunure." Rev. des Eaux et Forêts. 1897.

that the sapwood immediately inside the cambium is not killed by the frost, but its vitality is so impaired that it cannot form thyloses, nor is its contained starch converted fully into tannin, as in ordinary oak heartwood. Such wood is therefore **internal sapwood**, differentiated from normal heartwood by its light colour and by the presence in it of starch; its vessels also are without thyloses, so that it absorbs antiseptics which normal oak heartwood will not absorb. Hence if a solution of sulphate of copper be poured on the transverse section of the wood and the wood dried, the internal sapwood has a bluish tint, while the normal heartwood retains its natural colour. Henry, Professor of Natural History at Nancy, showed that both external and internal sapwood contains only up to 2 per cent. of tannin, while heartwood contains 6 to 7 per cent., the quantity diminishing as true sapwood is approached.

Mer examined numerous specimens of oakwood at Nancy and found that the most recent ring-shake in them dated from 1879, a severe frost-year, after which

for several years narrow annual zones of normal heartwood were produced, followed by zones of heartwood of ordinary width. The zones for several years anterior to 1879 were of ordinary width, but were not converted into heartwood, and formed the belt of internal sapwood. Mer found many cases of internal sapwood dating from frost-years earlier than 1879, such as the severe winters of 1829, 1794 and 1789; those of 1879 were quite sound, but those of 1829 were red, showing a commencement of decay, and those of 1794 and 1789 were brown and decayed, emitting a fetid odour not found in wood suffering from red-rot and said by Mathey to be caused by a decomposing ferment produced by *Amylobacter*. Fig. 60 shows internal sapwood, (a) sound and (b) unsound, though it is not

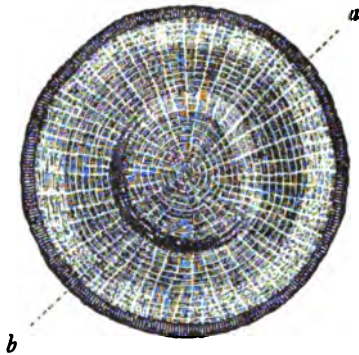

Fig. 60.—Internal sapwood.
a Pale. b Red. (After Boppe.)

usual to find both sound and unsound internal sapwood in the same zones.

Nanquette states that it is difficult to detect by mere inspections sound internal sapwood in oaken staves, as when the wood is long exposed to the sun and air its tint becomes indistinguishable from that of normal heartwood; it may, however, be detected readily by pouring water on the wood. Internal sapwood is as perishable as ordinary sapwood and soon decays in beams, and in planks gets wormeaten. Mathey says that much *parquet* flooring near Lyons containing internal sapwood has been attacked by *Lyctus caniculatus*.

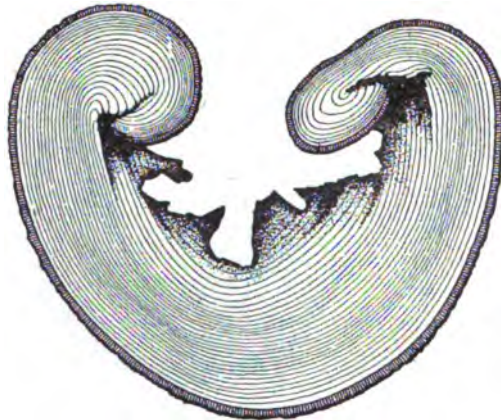

Fig. 61.—Beechwood injured by fire. (After Boppe.)

Wood containing internal sapwood when used for staves renders them brittle, so that casks thus made are not strong and give a mouldy taste to wine.

This defect occurs in all kinds of oak-wood, according to Mathey; it is

commonest in the wood of sessile oak, being rarer in that of pedunculate oak, while *Quercus tardissima* (*chêne de Juin*), which may be named the June oak, appears to be exempt from internal sapwood.

Burned Wood.—The cambium of standing trees may be killed by fire or by the sun, the latter causing *sun-blister*, or *bark-scorching*, which is described in Vol. IV. Fig. 61 shows a section of beechwood injured by fire. Beech and ash are specially liable to this form of injury owing to fires made by wood-cutters, but also frequently Scots-pine trees are rendered unsound at their bases by ordinary forest fires. Such wood is useless except as firewood.—Tr.]

Wood with **red or brown streaks** is not uncommon in spruce

or silver-fir, but somewhat rarer in the Scots pine. These streaks occur in two forms. Red streaks appearing simultaneously from the external surface towards the pith, through the whole length of a log, are caused if a barked log with superficial air-cracks is floated or rafted, or placed in a wet place. It is especially the air-cracks from which the red streaks start, that induce the growth of fungi the nature of which has not yet been determined. The longer the influence of the unfavourable environment continues, the deeper goes the mischief, which first affects the sapwood. Such wood is more or less unserviceable as timber, according to the extent of the decay to which it is subject: Hartig and Sepp have written on the red streaks in the wood of spruce and silver-fir from the Bavarian Forest, but the above remarks are founded chiefly on Mayr's observations.

A second form of red streakiness starts from a centre of decay, either in the stump or roots, or from the occluded snags of dead branches. It extends both up and down the stem.

Blue-streaks appear in the sapwood of logs of the Scots pine when they have been exposed for some time to damp, and a fungus, *Ceratostoma pilifera*, has gained admission to the wood owing to injuries to the bark. The commencement of this disease affects only the colour but not the hardness of the wood, though Schwappach and Rudeloff have shown that its elasticity is thus impaired.

Black-streaks in the sapwood of spruce and silver-fir, so that even the whole of a cross-section of the sapwood may become completely black, occur in logs which have remained lying for some time unbarked. When spruce logs are felled and stripped of bark in summer, drops of turpentine exude from numerous horizontal resin-ducts, and, between these drops, the wood in a few days becomes grey and gradually blackens, so that it appears to be spotted. The fungus that causes this penetrates the borings of *Tomicus lineatus*, from which also black streaks enter in the wood.

Dark-blue streaks are the first symptoms of the destruction of wood by two most dangerous fungi, *Fomes annosus* and honey-fungus (*Armillaria mellea*), both of which cause

root-rot in conifers. Usually they are found only at the lower end of logs.

Violet-coloured streaks and bands penetrate the heart-wood of many species of walnut, *e.g.*, *Juglans regia* and *J. Sieboldii*, instead of its being of the usually uniform brown colour. These are not signs of decay but raise the value of the wood, for the mottling of the wood may be due to alternations of colour as well as to ripples in its structure. The woods of deciduous species of *Diospyros*, that grow in warm temperate countries, have alternately dark and light grey bands of wood. [Similarly, alternations of black, brown or grey colour occur in the heartwood of numerous species of Indian ebony-trees, the most striking of which are *D. Kurzii* and *D. quaesita*, the latter yielding Calamander wood.—Tr.]

A **bluish-green tint** is assumed by the wood of all broad-leaved and coniferous trees that are attacked by the fungus, *Peziza aeruginosa*, this is chiefly the case with logs and branches lying on the ground in moss or dead leaves.

White streaks occur in the woods of oaks and other species when attacked by *Stereum hirsutum* and other fungi, and they are then said to be **white-piped**.

The white spots on a brown ground known as **partridge-wood**, though Mayr says that the German word for this is *Rehbunt* (fawn-coloured) and not *Rebhuhn* (partridge), is due to *Thelephora Perdix*, the true name of which is said by Massie to be *Stereum frustulosum*. Wood attacked by *Trametes Pini* is spotted with white, and if by *Fomes annosus* (*Trametes radiciperda*), with black spots on a white ground.

The red or greyish-brown coloured heartwood of beech, termed also **false heartwood of beech**, has been investigated by Mayr. He states that there are two kinds of this abnormally coloured heartwood:

Colouring-matter round the pith, which has possibly a similar origin to the colouring-matter in the heartwood of other species and has similar properties, namely, that of increasing its durability. When it appears in irregular patches on a cross-section of the wood it is prejudicial, as these patches can neither be stained nor impregnated.

[E. Hermann* states that the red heartwood of beech is caused by the obstruction of the cells of the medullary rays and part of the fibres of ordinary heartwood by thyloses and gum, which completely fill the vessels. Crystals of oxalate of lime also occur. The gum is formed from starch by metastasis. Red beechwood is harder and heavier than normal beechwood. It is quite impermeable by water and antiseptics. When occurring in patches it is not a commencement of decay but a defensive coating cutting off injured parts from sound wood. Mycelia from rotting wood cannot infect it. Certainly it may be used for railway-sleepers, being more durable than beechwood injected with zinc-chloride. Although creosote will not inject red beech heartwood, the latter is of itself highly durable and when the softer wood around it is injected it is perfectly safe from fungoid attacks. Mathey states that its price in France, owing to the prejudice against it, is about 2*d.* a cubic foot less than ordinary beechwood.

This red heartwood must not, however, be confounded with unsound beech heartwood and it is probably owing to the possibility of confusion arising between them that timber-merchants object to purchase it.—Tr.]

2. True decay in beechwood is caused by a brown or greyish-brown colouring-matter. According to common opinion, decay in heartwood originates when decomposing matter from broken boughs, snags or holes in the upper part of a tree descends the stem. But irrespective of the facts:—that decaying heartwood surrounds the pith; that in the central zones of heartwood there is scarcely any movement of water, which in trees does not follow gravitation, and that the injured vessels of branches become filled with thyloses, which are so many obstacles to the passage of colouring-matter that does not proceed from cell to cell;—no reliable proofs are forthcoming to connect decay from broken boughs with decaying heartwood.

Mayr states that injuries by mice or voles to young saplings cause decay in the heartwood. If the gnawed sapling is not girdled by such an injury, the exposed wood

* Kernbildung der Rotbuche, "Zeitschrift f. Forst u. Jagdwesen." October, 1902. Mayr says that railway-sleepers should not be made of red beechwood.

becomes occluded, but only after incipient decay of its surface; this decay proceeds slowly round the wound in all directions, so that when the tree is ripe for felling, from 5 to 20 per cent. of the cross-section at its base and about 10 feet of its length are affected. This unsound heartwood is liable to further decay and cannot be impregnated by antiseptics.

It is usually difficult to diagnose the health of a standing tree. The presence on its stem of bracket-like sporophores of *Polypori* and other fungi is a certain proof of unsoundness; all other symptoms are deceptive, such as: projecting occluded lumps in the stem; swellings in the stem especially near its base (Fig. 55); partly occluded snags with central depressions; presence of ants or mice among the roots. There is no difficulty in ascertaining whether or not a felled tree is sound; the axe can be used to cut into projections on the stem, while an inspection of the sawn surface of its base is usually sufficient; specially valuable boles may be split in two, as is done in the Spessart.

b. Abnormal Scents.

Any abnormal scent in wood, that may, however, be detected for only a few species, *e.g.*, oakwood, denotes decay. When decay has gone very far the wood has a mouldy scent like that of fungi.

c. Diminished Hardness and Sp. Weight.

If stem-wood is considered normal as regards sp. weight and hardness, branch-wood, especially the horny heavy branches of conifers is abnormally hard and heavy; root-wood is abnormally light; narrow-zoned coniferous wood is heavy, and narrow-zoned broadleaved wood, especially of oak, is light.

d. Defects in the Economic Properties of Wood.

In order to avoid repetition, it is sufficient here to refer to **defective shape** only. Besides a bent or conical shape in stems, that have been discussed already, **excentric growth** deserves mention. The woody layers are excentric when the pith on a cross-section is not the centre of the more or less circular annual zones of wood around it. All plant-part

deviating from a vertical direction are excentric, *e.g.*, all branches and roots; the pith is above the largest layers of wood in coniferous branches (*hyponasty*) and below it in most broadleaved branches (*de Bary*)* and in roots (*epinasty*). Similarly all stems that, owing to wind or snow, are oblique have excentric growth, *i.e.*, the pith is nearer their upper surface. Von Sachs and Hartig refer excentricity to pressure or gravitation; westerly winds exert pressure on a stem, and this causes the formation of wide zones of wood on its eastern side. The thicker bark on the upper surface of oblique stems and on the southern and western sides of border trees influences the formation of the wood, for the thicker the bark the less wood is formed.

Wood is fluted when its annual rings are crenate, that is wavy, as in the wood of hornbeam, Fig. 18, and of yew. Fluting may occur also in other species, and especially in beech, underneath a large bough where the thickening of the stem is less, while it is very vigorous on the two parallel sides of the depression that is thus formed.

There are two principal and several intermediate kinds of crooked stems. A stem may be spiral or curved (*sabre-shaped*): the former defect occurs chiefly in the common, or Scots, pine,† the latter in larch.

Spiral stems are the less valuable—the shorter the distance between the windings of the spiral; many entire stems are a part only of a spiral. This defect in the common pine is said by Mayr to be due to several causes, of which insufficient atmospheric moisture is the chief. The tree is worst-shapen in the driest part of its habitat, the south-west of Germany; in the moister and optimum climate of the species, West and East Prussia, Poland, Courland and Livonia, it has a perfectly straight stem; so also outside its optimum climate, in its most northerly habitat, in the moist climates of Norway, Sweden, Finland and Russia. Even in less favourable parts of Germany it is found that straightness of stem improves as

* [Mayr says that *all* branch-wood resembles that of conifers in excentricity.—Tr.]

† [As *Pinus sylvestris* grows all over Europe at different altitudes, and is indigenous in England and Ireland as well as in Scotland, the term Scots pine for it is a misnomer and its best name is "Common pine."—Tr.]

the temperature becomes less and the air moister, as in the Fichtel Mountains, between Saxony and Bohemia. Other causes of crookedness, but which are less important than dry air, are: injuries to saplings by game; loss of terminal bud or leading shoot by snow, wind, insects, etc.; rank growth on formerly manured agricultural land; shallow soil (rocky, or with a pan, etc.).

[Very straight lofty Irish pines grow in the moist climate of Doneraile, County Cork; also near Lake Thirlmere, the wettest place in Britain, with a thirty years' average rainfall of 84 inches. In fact the common pine grows well everywhere in the moist climate of the British Isles, provided the soil is a deep sandy loam, or even deep sand with sufficient moisture below, as at Woburn. Compact clay or calcareous soils, or sand or gravel that is too shallow for its roots, will not produce fine pines; the best and straightest stems occur in mixture with beech, or on suitable soils in the cool moist climate of Scotland, where the frequent curvature of young Scots pines is due chiefly to shallow notching of badly rooted nursery transplants.—Tr.]

Curved stems are due chiefly to prevalent south-west winds, especially on sandy soils, by which a larch stem is blown from its youth out of the vertical direction, while its strong upward growth contending with the wind-pressure gives the tree a curved, sabre-like shape from its base to its crown. This curved shape may be due also to injuries or to a bending towards the light, if it be slightly overshadowed by another tree. In the larch a bend in one direction is not counterbalanced, as in most other trees, by a subsequent bend in the opposite direction, but continues in one direction only, to the great deterioration of its timber. In Germany, unless a thinning is made before or immediately after a crop of larch has closed in, not more than 20 per cent. of the trees will grow up straight. Isolated larches are nearly always curved in Germany.

[Larch in Britain appears to grow straighter with its roots among boulders or in fissured rocks, even near the sea, as at Weston-Super-Mare, on mountain limestone. It is also straight and its heartwood red and sound on the oolitic

rock of the Cotswold Hills; on shallow soils in situations that are exposed to the south-west wind it is curved, as in Germany.—Tr.]

Curvature of stem occurs also in young broadleaved trees,

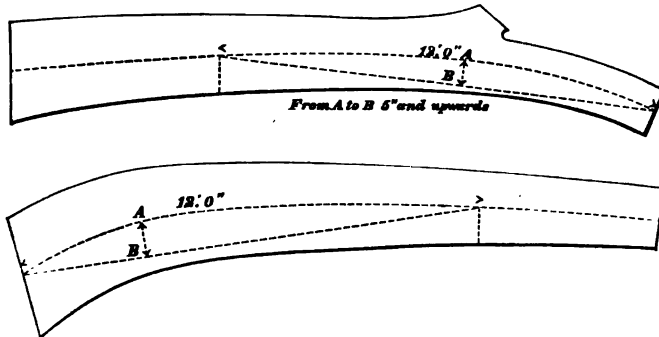

FIG. 62.—Oak compass-timber. A B is termed the *sagitta* or *camber*. (Laslett.)

and these should be removed in the early thinnings, even though, as is often the case, they are the most vigorous components of the crop. Poplars and willows in windswept plains all bend towards the north-east, but are straight and not curved.

On steep slopes all species of trees have a curved base, the convex side of which is turned towards the valley; this may be due to the sliding downwards of the snow in winter and its consequent pressure on saplings and poles. The

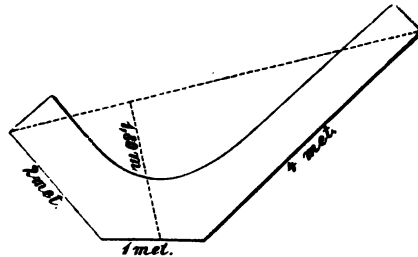

FIG. 63.—Knee-piece.

upper part of the stem is usually straight, and is vertical in conifers, but frequently oblique in broadleaved trees, oak, birch, etc., that grow out towards the light. The curved base of such trees may be useful for special purposes, but otherwise reduces the value of the timber.

[There was before the construction of iron ships a great demand for suitably curved or *compass* oak timber for the

Navy, and Fig. 62 shows the usual dimensions of such pieces, which were specially valuable. Even now curved pieces are used largely in the construction of barges, and in the Forest of Mormal near Le Quesnoy, in the north-west of France, these curved pieces of oak are still sawn up by pit-saws in the forest and not in sawmills. **Knee pieces**, used in barge-making, are formed where a bough, or root, parts from its parent stem; they may be of oak, pine, or spruce (Fig. 63).—Tr.]

Forking of the stem is normal in isolated broadleaved trees at a short distance from the ground. In trees grown in dense crops it is abnormal when the fork is lower down the stem than about 30 feet, as valuable long logs should be over that length. Irrespective of bad silvicultural treatment, soil and climate, in a word, the locality, may cause a tree to fork. It is certain that trees fork most on good soil, though the reason for this is unknown. If we consider individual species, it is found that, in oak and beech, forking is repeated at regular intervals along a tree. Every crop of broadleaved trees affords examples of this, and ash is also specially liable to fork, owing to loss of its terminal bud.

Beech trees usually swell at a fork, in the angle of which water collects, and this causes incipient decomposition of the wood below it, that is termed *Wassertöpfe* in German (water-cup).

Silviculture teaches us to remove forked trees in thinnings, but the necessary preservation of the density of the crop often prevents this from being done too radically. [It is not, therefore, always advisable, owing to danger of windfall or of admitting sunlight to the soil, to cut out all forked trees in thinnings. This is especially the case in crops of silver-fir, where there may be many cankered trees that require prior attention. Mr. Ingold, inspector of forests at Gérardmer, remarks on the difference between V and U-forked trees. When double leaders are united in a V, there is much bark between the two stems, for their union is being constantly raised as they grow in thickness, while in U-shaped stems the two leaders are independent. The V trees are, therefore, very liable to be split by the wind or snow, while the U trees are much more resistant. The former only are, therefore, removed in thinnings.]

In the case of broadleaved trees united at their base to form two or more stems, except in early thinnings, it is best to leave all the stems rather than to cut one, as each stem has a lop-sided



Fig. 64.—Four oaks each ten feet in girth. Forest of S. Gobain near Laon.

crown and when isolated is very liable to windfall, while together they have a united crown and frequently form a splendid clump of trees, as in Fig. 64.—Tr.]

As regards branches of broadleaved trees, that in young poles

rub against the main stem and against one another when the wind blows and eventually become naturally grafted together or to the main stem, so that the poles would grow into worthless trees, they should be carefully pruned or removed in early thinnings.

On broadleaved stems in high forest, **epicormic branches** (water-sprouts) are produced, when the stems are set free from a dense crop; this cannot be prevented entirely by careful thinnings. As this premature development of epicormic branches is usually due to the want of vigour in their crowns, such stems should also be cut in thinnings in preference to those clean-barked poles, which eventually produce the finest trees. In standards over coppice, the production of epicormic branches is normal after each cutting of the underwood and then they should be pruned carefully.

Sapling-shake (Heisterknick) is a defective bend in the stem of oaks at a height of about 6 feet from the ground. It is so named, because it depends on the planting of saplings of 6 feet, their usual height, in oak woodlands.

e. Defects in the Chemical Properties of Wood.

The investigation of chemical defects in wood has been so meagre, that only a few remarks on this subject can be offered. Cieslar proved that the relative mass of lignin, as compared with that of cellulose, in wood, depends on the amount of heat and light to which the tree has been exposed. Suppressed poles are, therefore, defectively constructed, for they contain too great a percentage of cellulose; it is reasonable to assume that thus those economic properties which depend on the sp. weight of wood will be prejudiced. By lignification, *science* means the storing of lignin on the cellulose walls of woody tissues, but *in practice*, the word denotes the resting-phase of vegetation at the end of a growing-season, the hardening of yearling shoots and of the last annual woody zone, that are then said to be lignified. Susceptibility to early frost of insufficiently lignified tissues does

not depend on a scarcity of lignin on the cell-walls, but on the presence in their interior of plasma, that has not been converted in the cambium and other parenchyma into frost-hardy resting-plasma. The further a plant-part is from the latter condition, the more danger it incurs from autumnal and winter frosts. [The tissues of delicate green-house or hot-house plants, *Eucalypti*, *Pinus palustris*, etc., in which growth continues in their native habitat till interrupted by excessive draught, have no resting-plasma ready for the approach of our winters; they are, therefore, killed by the first moderate frost. —Tr.] Hence hardiness against winter-frost, in plants that withstand it normally, depends chiefly on the preceding weather and treatment they have experienced. The prevalent opinion, that after the cells have parted with their contents, and even in dry heartwood, lignification of the cell-wall may still proceed, is in itself highly improbable, owing to the absence of plasma, and has never been proved to be true.

Abnormal formation of gum, **gummosis**, occurs in the wood and bark of species of *Prunus*, as well as in those of certain tropical trees belonging to various natural orders (*Acacia Senegal* said by Gamble to yield true gum-arabic, *Bauhinia retusa*, etc.). It is due to metastasis, or chemical transformation into gum of parts of the tissues.

Resinosis, or conversion of the cell-walls into resin in coniferous wood, has been disproved by Mayr* (c. f. resin-galls, p. 125). He has also shown that pathological conditions in a tree may cause resin to form. The outflow of resin in logs is not due to metastasis, but is a mechanical process, the resin being pressed out of the resin-ducts by the drying and shrinking wood. In wounded living trees, the flow of resin is a physiological process caused by turgor of the tissues.

All abnormal tints in wood, whether they result from ferments caused by fungi, or without their action, are due essentially to metastasis, but little is known regarding their origin.

* H. Mayr, "Das Harz der Nadelbäume." 1894.

CHAPTER II.

FELLING AND CONVERSION OF TIMBER.

THE second chapter of this book deals with the methods of felling trees and converting them into logs and scantling, which are then handed over to the consumer.

The foremost rule in conversion of timber is also common to all industrial undertakings, and is as follows:—Consider carefully the uses which may be made of the raw material, and then act as far as possible without diminishing the productivity of the forest, and in accordance with the current demands of the market.

Since the produce of every forest comes under the influence of a special market, the wares required by which are multifarious, while local requirements, customs, and usages are also influential, there must be many modes of conversion suitable for different localities. In the following sections, therefore, the results of experience are considered, their utility gauged, and a decision formed as to the basis of a rational system of Forest Utilization.

SECTION I.—MANUAL LABOUR.

1. *General Remarks.*

The productiveness of every industry depends on the number of available labourers, and on their skill and mode of organization. Hence, the conditions essential for profitable forest utilization are plenty of good woodcutters, and good arrangements for furthering their labour.

The worth of a woodcutter does not depend only on the value of the material which he can convert in a given time, but also on his following the rules of Silviculture and Forest Protection.

In all forest management based on the highest possible pecuniary return, which may be termed **Economic Forestry**, it

is in Germany a general rule to entrust the fellings to woodcutters under the pay and control of the forest-owner, and only exceptionally to employees of wood-merchants. The latter method was formerly more frequent, and is still followed largely in France and Britain, and occasionally in Germany.

Speaking quite generally, whenever the sale of the wood will barely cover the cost of its conversion, timber-exploitation may be left to the purchaser of standing trees, either by the sale in block of all standing trees on a certain area, or by single marked trees. In high mountain-districts there are localities difficult of access, where frequently the conversion and transport of timber would cost more than its value, if done by other agency than that of the timber-merchant, such as State agency, or that of a private forest-owner. In such cases it is better to sell trees to a merchant. Where timber has to be given away to right-holders, in cases where only inferior material is in question and there is no fear of the right-holders defrauding the forest-owner by taking too much produce, it is also better to allow them to fell and convert the trees. In forests belonging to poor communes, or villages, it may be more economical for the villagers to work-out the timber for themselves.

In all these cases restrictions for the benefit of the forest must be imposed on the woodcutters, just as if they were directly under the control of the forest-owner.

It is evident that only by the employment of woodcutters engaged and paid by himself can the forest-owner maintain a satisfactory and permanent labour-force, and this he should always endeavour to secure. Such an object, however, is not always attainable, and though to secure this is occasionally easy, it is sometimes very difficult. This depends on local circumstances, and especially on the superfluity or want of labourers, the duration of work in the forests, and the conditions of employment offered to the labourers by the forest-owner.

The supply of forest labour fluctuates with the season of the year. Owing to increased production of wealth, to modern laws regulating industry and to the rapidly improving means of transport, the conditions of labour have altered considerably

during the last thirty years, and forestry has not remained unaffected. The woodman, who formerly remained attached to his hamlet, has freed himself from his fetters: he leaves field and forest, and proceeds to the centres of industry and manufacture where he hopes to get a better price for his labour, to lead a pleasanter life than in his lonely forest village, and to acquire property more rapidly. A few years ago, owing to this migration of the villagers, the scarcity of labour in certain forest districts had become calamitous. The crisis, however, did not last long, and at present, many woodmen have returned to their former pursuits.

The duration of work in the forest depends on the local extent of the forest area and the degree of intensity of forest management. Whenever in an extensive forest district there is always full employment throughout the year, the inhabitants are closely attached to the forest. In such districts there is hardly any other industry but forestry; and, even if other employment could be found for the men, outside or within the district, yet, provided they can earn the usual wages prevailing in the locality, forest work is preferred to any other industry by the greater part of the population, who have, as it were, grown-up in mind and spirit with the forest. Where, on the contrary, in districts chiefly industrial or agricultural the work in the few existing forests can be done in a few weeks' time, forest work is only an auxiliary to the usual modes of occupation, the labourers have for it little taste or skill and can be induced to work only in a perfunctory manner.

The Remuneration and other Conditions which the woodmen receive from the forest-owner should under all circumstances be a fair equivalent for the amount of labour required, and suffice for the support of a labourer and his family. It is, therefore, clear that the more a forest-owner can identify his own interests with those of his woodmen, the more remunerative will be the management of his forest.

2. Demands on the Woodcutter.

People are apt to think that the demands made on a woodcutter may be satisfied by any labourer who can use the axe and saw. This is indeed true in certain cases, but usually a certain

amount of skill, foresight, power of reflection and experience is required, attainable only after prolonged labour in the forests, which all workmen are not equally capable of acquiring, and is not found in an equal degree in all forest countries or districts. All industrial operations are more or less dependent on the skill of the workmen employed, and the demands which forestry make on labour form no exception to the rule.

It is necessary to distinguish woodcutters of different grades of utility, and to distribute the work among them according to their capability. Whilst for work in high forest, clear-cuttings, coppices or thinnings, the ordinary labour force may suffice, natural regeneration-fellings and cutting of uneven-aged crops and mixed woods demand much more skilful hands. There is a great difference between working forests for fuel, and working them for valuable timber or where a careful and detailed mode of converting the timber is required.

Besides the demands made on skilled labour by special conditions of forest management, which vary with the locality, there are others of a general nature that must be made on every woodcutter, or gang of woodcutters, as regards order, capacity for labour, and control. A consideration of these points leads to a statement of the conditions of agreement between the labourer and the forest-owner, which should be explained thoroughly to every woodcutter before he engages to work in a forest. Although these conditions vary for different forests, or localities, in order to provide for important local requirements, there are others which prevail throughout a whole province or country. Such general conditions are, therefore, decided usually for extensive forest tracts, leaving the specially local conditions to be added where necessary, penalties for breach of agreement being included.

The following are the usual clauses in an agreement with a woodcutter :—

I. GENERAL CONDITIONS.

A. OBLIGATIONS OF THE WOODCUTTER.

- (a) Regarding his conduct during the engagement.
- (b) Regarding felling.
- (c) Regarding conversion of timber.
- (d) Regarding removal of timber.

B. OBLIGATIONS OF THE WOOD-STACKER, AND OF THE FOREMAN.

C. OBLIGATIONS OF MEN EMPLOYED IN CARRYING AND FLOATING
TIMBER.

D. OBLIGATIONS OF THE CONTRACTOR.

II. SPECIAL CONDITIONS.

III. PENALTIES.

A. OBLIGATIONS OF THE WOODCUTTER.

(a) **Conduct of Woodcutter.**—As regards the conduct of the woodcutter, the following are the chief points:—

- i. No one is allowed to do other than the special work allotted to him.
- ii. Every woodcutter must be at work punctually at the appointed hour, and should work steadily and without intermission until the work is completed, except during the off-time agreed upon.
- iii. Any woodcutter absent without permission from work will be warned on the first occasion, and on the second will be considered to have vacated his work of his own accord.
- iv. No work is to be done before sunrise or after sunset.
- v. Every woodcutter is to provide his own tools in good condition and he should also have a two-foot rule. Wood for mending tools and for constructing huts for the workmen is provided by the forest-guards. When the work is completed, all wood used for huts, timber, sledge-roads, etc., should, as far as possible, be converted into firewood.
- vi. Every woodcutter should be as careful as possible in carrying out silvicultural rules, and obey the special instructions of the manager and guards in this respect. He is also held responsible to report any infractions, which have come to his knowledge, of such rules by any other workmen.

- vii. The woodcutter is not allowed, either by himself or his family, to remove any wood from the felling-area. At the completion of the felling and conversion of the produce, all broken pieces, chips, and other wastage, will be divided among the workmen.
- viii. Each foreman is responsible for the security of the wood worked by his own gang.
- ix. Fires should not be made by less than six workmen, whenever a larger number is present on a felling-area. Great care must be taken of the fire and it should be extinguished, or carefully guarded, every evening.

Rules under headings (b) to (d) as regards felling, conversion, and removal of the timber will be given in the sections dealing with these subjects, and also with B. and C. Special conditions, II., depend on local circumstances.

III. PENALTIES.

The third part of the conditions of agreement gives the penalties for infraction of any of the above stipulations.

Such penalties may be pecuniary, such as deductions from wages, temporary suspension from work, or dismissal, and, whenever the woodcutter obtains certain privileges from the forest-owner, such as land for cultivation, wood, litter, etc., temporary or permanent deprivation of such privileges.

Certain offences by woodcutters and other forest labourers are punishable under the forest law.

The penalties should be those usual in the district, and within the means of the working population.

Deductions from wages and deprivation of privileges are the most suitable penalties for the poorer workmen. Whenever experience shows that penalties are unavailing, it is better not to include them in the conditions of agreement, for in such a case it is better to have no law than one that cannot be carried out. There are at present many districts where this is the case, and where penalties cannot be enforced owing either to the poverty of the people or to the scarcity of labour.

3. *Wages.*

(a) **General Remarks.**—The remuneration to the woodcutter for his labour consists chiefly in a regularly contracted payment, but partly in undertaking to contribute to his support or that of his family in cases of accident, sickness, undeserved want, etc., and occasionally in special rewards paid to skilled labourers for difficult and unusual work.

One of the best means for retaining the services of the better part of the labourers for forest work is to allow them certain forest privileges gratis, or at reduced rates, such as small areas of land for cultivation during good behaviour. Friendly societies for saving money for old-age pensions or allowances during sickness, or for injuries, to which the forest owner contributes in proportion to the regular contributions by the labourer, may be mentioned here.

Among all these items the wages are naturally the most important; these may be either **contract-wages** by the piece, and proportional to the amount of work done, or merely **daily wages**.

Woodmen are employed usually on **piece-work**, which is the cheapest and fairest method; daily wages are exceptional, and are given only when the trouble taken by the workman is out of all proportion to the reasonable amount of work done, or, as in forest plantations, where if the work be paid by the number of plants, the latter will be planted carelessly, without proper attention to their roots

A piece of work done, or **work-unit**, may be measured in various ways, either by its weight, volume, or roughly-stacked volume; or by the chief determining measure of the work, as for instance, the length and mid-diameter of a log, the yard of ditching, the hundred planting-holes of definite size, the single railway-sleeper, etc. Weight is not much used in forestry as a unit of work, but the common unit for timber is the cubic foot, or load of 40 cubic feet for hardwood and of 50 cubic feet for softwood, both corresponding roughly to a ton. Stacked firewood is measured by the cord (6 feet \times 6 feet \times 6 feet) of 216 stacked cubic feet, and faggots by the hundred.

Timber may be measured by its dimensions, and the diameter of different pieces may be used as a unit. Such a measurement of his work is more easily appreciated and calculated by the woodcutter than when the cubic foot is the unit for measurement, and it is also a fairer measure of the work done than the latter. It has not yet been decided whether it is more profitable, or not, for the forest-owner to measure the work for payment by the diameter of the piece, or by the cubic foot, but experiments made in Saxony are in favour of the former system, which is much the commoner of the two. Wherever logs are sold by their length and the diameter of the smaller end, these latter should also be taken as the units of work.

Whatever unit of work may be chosen, the **pay-unit** must now be calculated, and naturally this varies more or less with the time and locality, and depends chiefly on :—the supply of labour ; the extent and variability of the demands for labour in a district for manufactures, agriculture, public works, traffic, etc. ; the actual cost of the necessaries of life ; the value of money measured in commodities ; the economic condition of the people ; the inclination of workmen for forest work, etc. Different measures may be taken to rectify the greater or less variability of the circumstances which affect wages. Either a permanent table of average wages is compiled, the wages being increased or diminished when necessary, or new tables of wages may be prepared annually, according to the price of labour. In the latter case a written agreement to hold good for a year between the forest-owner and the workman must be made, and signed by both parties.

Besides the fact that it really furthers economy to secure fair wages to the workman, it is also clearly in the interest of the forest-owner, as contented workmen will avoid waste in felling and converting timber, and damage to young growth. Care for the welfare of the forest depends more or less directly on the woodcutter's work, and the latter will always turn the rate of pay to his own advantage. The amount of care he takes of the forest will be always the less, the lower his wages are driven by the competition of other workmen. In forest

management, as in all great productive industries, the determination at any time of fair rates of wages is of the greatest importance, and the question then arises, how should this be done?

(b) **Determination of Rates of Wages.**—It is clear that the woodman must obtain as high wages in the forest as he could get by a similar expenditure of labour in any other rough industry. The forest-owner has to compete for his labour-supply with other industrial enterprises; he may usually compete with them successfully when he remembers that the industrious woodcutter should receive wages for the hard and frequently dangerous forest work in ordinary fellings, somewhat above those actually in force for other works in the district. This addition to the ordinary local wage depends on the favourable or unfavourable aspect of the circumstances affecting wages that have been already described; it may be sometimes 10 per cent., 20 per cent., or even 30 per cent. above the usual daily wages of labourers. The amount of the daily wage once settled, the next step will be to fix the pay for each unit of work in accordance with it.

It is easy to ascertain from the results of the previous year's felling, what amount of work an industrious workman can do in a day, *i.e.*, how many cubic feet of converted timber he can prepare in summer in ten hours, and in six or seven hours in winter, and in this way, given the rate of daily wage, the rate per unit of work can be fixed.

There are, however, several classes of wood produced in each forest, and a distinction must be made between conversion of firewood and that of timber of different varieties. As regards firewood, it should be noted that split billets are frequently the predominating class. As regards classified timber, it cannot be predicted which class will predominate; that depends on the mode of conversion and the size of the trees, etc. Thus, in some districts, middle-sized butts for saw-mills—in others, averaged-sized logs—will be the material on which the woodcutter bestows most of his labour, and for which the rate should be fixed. Firewood and timber are produced by all forests, so that there are two standards of rates of pay, of which one is for a cord of split firewood, and

the other for a unit of that class of converted timber which the forest yields most abundantly.

(c) **Scale of Wages.**—The standard rates, therefore, consist in those paid for cordwood and for one kind of converted timber: but on every felling-area there are several—often many—classes of timber and firewood, the preparation of which does not exact the same amount of labour, or the sale-values of which are highly dissimilar; there must therefore be several grades in the rates of pay for piece-work. These different piece-work prices are always multiples, or parts, of the two standard rates of pay, and in their case the amount paid, besides being, as far as possible, proportional to the work done, should also be proportional to the sale-value of the converted material.

As regards the former of these factors (the expenditure of labour on any work) round billets are prepared more easily than split-wood, and should be paid for at a lower rate; whilst the preparation of 100 bean-sticks should cost less than that of 100 hop-poles.

The amount of labour involved in the work is, however, made subsidiary to the sale-value of the outturn, and the maxim of making the labour-charge for preparation of more valuable material higher than for what is less valuable is of the highest importance. Thus, the preparation of the better classes of logs or scantlings is remunerated more highly than that of the lower classes, even when the amount of labour expended is the same in both cases; this is especially true for long pieces of valuable timber, provided the diameter at the small end is up to standard; a higher payment would be made for the entire piece than if it had been cut in two, although in the latter case more labour would have been expended.

There are forest districts where, in the interest of the forest owner, the wages of woodcutters are allowed to rise and fall with the sale-prices of the outturn; as in parts of the Schwarzwald, and especially in the forests of the Prince of Fürstenberg. The best plan is, therefore, to pay relatively the highest rates for those pieces, the sale of which is most profitable to the owner, and to pay the wages corresponding to the labour

involved only for less saleable pieces, the number of which the owner wishes to keep as low as possible. Thus, payment for wood from the stump and roots of the trees is kept very low, to prevent material fit for straight, split, or round cordwood being thus used, and especially to keep down as much as possible the amount of root- and stump-wood.

(d) **Area where the Same Wages Prevail.**—Once the scale for labour-payments has been decided, it may be applicable to a forest district, range, or working-circle, but sometimes only to a particular felling-area. Thus, where the locality is unfavourable, as, for instance, on steep, lofty slopes; in fellings where special care has to be taken of the material, or of the regeneration or tending of the forest; in very remote felling-areas, where the woodmen have far to go to reach their work; where the trees to be felled are far apart, so that there are difficulties in collecting and sorting the outturn; and in several other cases,—greater demands are made on the labourers than where opposite conditions prevail.

The preparation of forest accounts is much simplified when the same rates of payment are made in all the felling-areas of the same forest range. In level, uniformly-stocked forests, and especially where only one species of tree is grown, such simplicity is often admissible; but in the case of irregular woods and unlike conditions, the forest-owner will find it to his profit to have different rates of payment for different localities.

Thus, we have various rates of payment for piece-work that rise and fall with the local daily wage. In allotting these rates according to the different kinds of produce, too much detail should not be attempted, so that the accounts may not become too complicated. An exception to this maxim arises only in the case of forests yielding highly valuable timber.

(e) **Wages for Barking Trees, Stacking Firewood, etc.**—When the rates of payment for felling and converting the timber have been settled, it is usual to enter in the agreement the rates for barking the trees, also for collecting the timber and stacking the firewood. The latter work usually involves only one rate, but in the case of collecting the timber in temporary forest depots, the greatest differences of rates,

compared with the average rates for pieces of the same size, may prevail.

In level land, it is necessary to convey the converted wood only to the nearest road, or timber-depot, and the amount of labour involved is practically the same in all cases for pieces of similar dimensions; but in mountain-districts there are, as a rule, great differences in this labour, and it is usual to fix different rates for each felling-area at different altitudes. [In Britain it is a common practice to pay for felling and barking oak trees by the ton of bark that results—120 cub. ft. of timber usually yielding a ton of bark.—Tr.]

(f) **Daily Wages.**—There are cases where either the work done cannot be measured, or special demands are made on the ability, experience and care of the workmen that must be considered in fixing wages, for in these cases it is quite exceptional that the work is at all proportional to the energy expended on it. If a special agreement cannot be made, daily pay should be given. Thus in cleanings or early thinnings, in pruning trees, the work done cannot be measured. For constructing the various means of water-transport; making or repairing roads, slides, bridges; building substantial huts for workmen; setting-up fences, and so on, the skill of a carpenter or engineer is required, although it is frequently only a woodcutter who does the work, and then he should be paid in proportion to his skill. Only experience can guide the forest-manager in settling a fair wage for such work.

All the above conditions regarding wages form the terms of a written agreement between the woodcutters and the forest managers as a rule; an agreement should be for an indefinite time, with a stipulated period for notice by either party of its termination. It is wrong to make the agreement only for a year, as there may be difficulties about renewing it. It is also wrong to delay a fresh agreement until the workmen give notice of dissatisfaction with the current rates of pay; this may dissolve the friendly ties between the workmen and their employer.

The woodcutters' agreement, therefore, provides for its renewal and for notice of terminating it, also for the rates of

pay, and manner of payment. It should be signed by all the workmen and by the forest-manager.

4. *Organisation of the Labour-Gang.*

(a) **General Account.**—It is evident that the efficiency, as regards quality and quantity of outturn, of the whole force of labourers employed in a forest, leaving out of consideration their special aptitude for the work, depends greatly on the supervision the foresters and forest-guards can exercise over them. The influence and the possibility of its leading also to useful results depends on the relations of the woodcutters to one another, and on their attachment to the forest and its interests. All this varies considerably from place to place, and in certain cases it is hardly possible for the forest-manager to exert the desired influence, whilst in others he can do so quite easily. In order, however, to do what is possible in this respect and supervise the hundreds of woodcutters who may be employed in any forest-range, as well as to distribute them suitably among the different felling-areas and pay them proportionally to their labour, a certain organisation of the whole force of labour must be instituted, subdividing them into gangs and parties, and appointing from amongst themselves certain influential persons as foremen and heads of parties. Usually the gangs are composed of all men coming from the same village (or district), and their leader is termed a foreman. A party consists of the number of men, not less than two or three, required for complete felling and conversion of a certain lot of trees. The party chooses its own leader, works together and divides the payment for the work done into equal parts among its members.

Considerable importance should be attached to the choice of the foreman, as he is the intermediary between the workmen and the forest officials and is more or less responsible during the absence of the latter for the conduct of the woodcutters. On account of the indispensable nature of his services it is advisable to attach him as much as possible to the forest and to keep him constantly employed; he should also have special privileges. He usually settles the accounts with the men,

and obtains a small percentage of the total payment for doing so.

The connection of the woodcutters with one another varies in different places, depending partly on the possibility of carrying out the organisation already described, and partly on local laws regarding workman and employer. It is often very difficult to enforce penalties against the woodcutter for non-fulfilment of the contract, or agreement, made between him and the forest-owner, although it may be advisable if possible to secure such an agreement. Whether an agreement is made with all woodcutters or with some of them only, or with the foreman on behalf of the other men, depends on the particular class of labourers to be dealt with. Woodcutters may be classified as follows :—

(b) **Non-Associated Woodcutters.**—Where forest blocks are found scattered amongst agricultural lands, forestry is only an accessory means of employment for the people, and no regular gang of woodcutters exists. The men engaged for forest-work are a motley crew following all callings and without any connection with one another. The attachment binding the woodcutter to the forest is in such cases generally of the slightest kind, and even if a legal act of agreement be made between him and the forest-owner, it will be only of a temporary nature, depending on his own interest and liking for the work. In this class there is no association between the different woodcutters, each man works independently of the others, or they may work in pairs in the case of sawyers. Very often such a gang of woodcutters is composed of quite different individuals at the close of a felling to those who commenced work on the same area. In such cases, if the forest-manager wishes to secure attention to the most necessary protective rules, he must make a **separate agreement with every labourer.**

(c) **Associated Labour.**—In extensive forest districts in plains and mountains the conditions of labour differ greatly from the above. The chief means of livelihood of the inhabitants are then obtained from the forest and the work it affords; the people consider it an honour for a man to be employed in the forest, and forest work is preferred to all others which

may offer. A few of the people possess all the best qualities of these woodcutters, and are most attached to the forest and most trustworthy in working, and have much influence over the other men. In such cases it is sufficient for the forest owner to make agreements with the more influential woodcutters when they are sufficiently numerous to form a regular enrolled gang constantly employed in the forest, and have a common insurance fund to which the forest-owner contributes. Such a labour-gang is strengthened from time to time, as necessity arises, by engaging other men temporarily.

(d) **Contractors' Men.**—Sometimes the legal act of agreement is made by the forest-owner with a contractor, who undertakes to supply all the men required for any definite piece of work in the forest. Contractors are frequently active, influential and fairly wealthy men who have considerable tact in managing woodcutters. This assistance simplifies matters for the forest-owner, as the contractor has all the worry and trouble of managing and supplying the labour-gang, and of paying them in detail for the work done. In extensive forest districts, insufficiently supplied with experienced foresters or forest-guards, or where the woodcutters are very experienced and trustworthy and the work can be largely left to them without much supervision on the part of the forest staff, it is often better to entrust the conversion of the timber to an experienced contractor who thoroughly knows the capacity of individual workers, and can give full security to the forest-owner for good work. This system has, however, its shady side, as contractors sometimes defraud their men.

The contractor is often obliged to bring his men from a distance (as in the case of Italians employed in Germany); he then requires pecuniary advances and concessions, which are not necessary under ordinary circumstances. Timber-work is largely done by contractors in the Black Forest, Alps, Hungary, Galicia, and in many extensive forest districts of the North German Plain. In the Alps the contractors are frequently mayors of villages. Although, strictly speaking, the contractor is responsible for the conduct of his men, the forest-manager does not abstain from direct supervision over them, and it is evident that the contractor must

be bound legally by conditions covering all the interests of the forest owner.

In the case of **extensive damage to forests** by wind, insects, snow, etc., when there is an extraordinary amount of material to be converted, it is generally necessary to entrust the work to contractors. Often in such cases the workmen are brought from a distance, as Italians in South Germany, etc., and it is necessary to make arrangements which the ordinary course of forest-work does not require.

In the years 1891—93, damage by the nun-moth in S. Bavaria rendered recourse to contractors necessary. About 10,000,000 tons (9,963,000 c.m.) of dead wood had to be felled and converted as speedily as possible. A band of about 3,000 men had to be imported and organised. Twenty-five barracks with heating-apparatus and beds had to be built, each for 50—60 workmen, and provision made for feeding them, with medical attendance, hospitals, and a police force. Telephones were installed, and the number of forest-guards increased considerably. It was necessary to set up a temporary office, with clerks and accountants. All this was done with such skill and financial success as to bring great credit on the Bavarian Forest Department. After this work had been completed, forest management returned to its ordinary channels.

(e) **Work done by Forest Settlers.**—Hitherto it has been presupposed that for ordinary fellings the necessary labour-gang could be secured within easy distance of the forest, but there are forest districts where the population is so scattered and scanty that the needful force of labour cannot be obtained in the neighbourhood; the manager is then obliged to engage labourers from a distance and settle them in a regular colony within his forest. It is evident that only in the last extremity of scarcity of local labour would a forest-manager resort to such an expensive measure as the above.

Such colonies of forest-labourers are found at Herrenwies in the Black Forest, and in other parts of Germany, also in certain districts in Hungary. The settlers must be supplied with houses, food, medical attendance, schools and churches, plots of land to be cultivated and meadow-land for each

head of a family, also litter and firewood; even their widows and orphans must be maintained.

[Imported labourers from Chota Nagpur are largely employed in the Assam tea-gardens under conditions similar to the above, but the Indian Forest Department has hitherto been able to dispense with the necessity for resorting to such a class of labour.—Tr.]

5. *The Forest Labour-question.*

As already stated, the position of labourers has altered greatly in the last forty years, and instead of the former contented, industrious woodcutter, forest management has to deal with a fluctuating proletariat. The forester is called upon to improve this state of things, not only on the grounds of national economy, but also from a special forest economic point of view; although he cannot control all the factors in the question, he can to some extent assist in organising a physically and morally strong force of woodcutters. Some notes showing how he should proceed to gain this object are given below.

Wages should be high enough to remunerate fairly the hard forest work and the increasing dearness of living. The supposed gain to the forest-owner by low wages is often converted into a loss, ten times as great, by bad workmanship, while moreover damage is done to the forest. The maxim of the lowest possible wage is much more objectionable in forest work than in any other industry.

It has long been admitted by experienced foresters that it is highly advantageous to fix remuneration for work done, at rates proportional to the sale-value of the outturn. Let the roughest kinds of work be well paid, but fix rates at least double the ordinary ones for valuable produce. The amount the woodcutter thus gains will secure from him an intelligent and profitable conversion of the felled trees, will excite his attention and care, increase his utility and enable him at the same time to increase his own earnings. Small rewards also should be offered to woodcutters for new tools, and other improvements.

The system of giving the work to contractors should be abandoned, whenever it is known or suspected that the contractor is making more money that is absolutely necessary out of the workmen; in such cases direct dealing with the latter should be substituted, or other means taken to protect the men from imposition.

In order to induce good woodcutters to become attached to the forest, as far as possible, **permanent work** should be provided for them; certain works should be kept in abeyance, so that as soon as the harvest or other agricultural business is over work may be found for the strong young woodcutters. Naturally, in such cases, the best and most trustworthy men will be most favoured. Attempts also should be made to lighten the men's work, by constructing woodcutters' huts in remote felling-areas and introducing labour-saving appliances.

Another effective incentive is to offer the men **forest privileges** at low rates. Such privileges are highly valued by country people, and they think nothing of the labour involved to themselves in taking advantage of them.

Within the limits allowed by Forest Protection many a privilege of little value may be bestowed, which is paid for tenfold by the services of good woodcutters. Such are:—assigning small allotments of forest lands for cultivation at a low rent, during the good behaviour of the woodcutter; or of building-timber, at cheap rates, for the construction of new woodcutters' houses, or repairs of old ones.

Appointments, when vacancies arise, of useful woodcutters who have served long in the forest, as forest-guards, fire-watchers, road-guards, foremen, etc., can be given but rarely, but may be mentioned with the other means of attracting good men to the forest. The frequently indifferent pay of forest-guards, and in Germany, the preference given to old soldiers for these posts, often render this impracticable.

In many forest districts **friendly societies** are established to which every woodcutter is obliged to contribute a certain percentage of his wages, and the forest-owner also contributes proportionally. From these deposits allowances are made in cases of sickness or accident, and usually also to old wood-

cutters' widows and orphans. If these societies are to be real incentives to a steady labour-force, they must dispose of sufficient capital and offer real and sufficient help in times of need. Several of these funds are very substantial concerns ; as at Clausthal in Hanover, in the Sihlwald belonging to the town of Zurich and other localities. There is now a general Imperial Fund for the whole of Germany to provide insurance against accident, and pensions in old age for workmen of all classes ; from this fund the best results may be expected. In Bavaria, by a State decree of the 26th December, 1898, this now includes allowances to forest workmen in cases of sickness.

SECTION II.—WOODCUTTERS' IMPLEMENTS.

Although custom, experience, and skill may to a certain extent supply the want of good implements, it cannot be denied that, in every industry, not only more but better work can be done with good tools than with bad ones. This must necessarily be the case in forestry, and the more so, the less skilful and experienced are the woodcutters who are employed. The supply of good implements is, therefore, an important object for the forest-manager which he must always keep in view.

Woodcutters' implements are classified according as they are used for hewing, sawing, splitting or grubbing-up the wood.

1. *Hewing Implements.*

Hewing implements include **felling-axes**, **trimming-axes** and the **billhook**. The two former are heavier than the last, and are used with both hands on large timber, whilst the billhook is used with one hand only, for cutting saplings and brushwood. The two kinds of axes differ, in that the former is sharpened symmetrically on both sides of its edge, and is used for converting wood in the rough ; the trimming-axe is used for shaping the wood, it has an unsymmetrical edge, flat on one side and sloping on the other.

Axe-heads of both kinds are made out of oblong pieces of iron which are beaten thin at the ends, and then bent to form an eye

for the handle. In order to give the axe a sharp edge, a wedge-shaped piece of steel is placed between the thin iron ends, and they are then welded together, or in the trimming-axe a steel plate is welded to the side which remains flat.

The **falling-axe** is the handiest of all woodcutters' tools, and in cases of necessity, however improperly, it may be used as a substitute for almost any other tool. It consists of the **axe-head** and **handle**, the latter made of a tough split piece of ash, hornbeam, beech, robinia, hickory or whitebeam; the hole in the **axe-head** into which the handle fits is termed the **eye**, and usually widens-out on the side opposite that where the handle is inserted, to allow of a wedge being driven in to hold the handle firmly in its place. The part of the axe away from its edge, including the eye, is termed the **back**, and may be curved or flat, and in the latter case is of steel. The cutting part is termed the **blade**, which may also be either straight or curved.

The characteristics of a good axe are: that the edge shall be sharp and the steel of which it is composed possess the proper degree of tempering, so that when used, on the one hand, it may retain its cutting-edge without the latter becoming bent, and on the other, the edge may not be too hard, and break. As regards shape, the axe should form a tapering wedge with smooth sides. In order to reduce friction as much as possible, the sides of the axe should be slightly convex, or there should be a slight projection in the middle of the blade. The weight of an axe, its size and relative dimensions depend on whether it is to be used for hard and heavy, or soft, light wood. In the former case the action is chiefly cutting; a finer edge is then required and the axe should be lighter and thinner than one used for softwoods, which in all parts, and especially in the back, is thicker and broader than the hardwood axe, acting more like a wedge.

In no case, however, should the axe be too large or heavy, as it then fatigues the woodcutter and does not work so economically as a lighter implement.

The **axe-handle** is sometimes straight and sometimes curved, sometimes parallel to the edge and sometimes bending from or towards it. It is difficult to decide which shape is most

advantageous; it is often made so as to taper away from the end, and thus afford a better hold.

Fig. 65 shows the shape of the Kenebeck American axe, the edge of which is made of compressed steel and lasts almost indefinitely. It is said to tire the woodcutter less than any other axe, and can be used to cut horizontally. It is made in two sizes, weighing respectively $5\frac{1}{2}$ and 7 lbs., including the handle, and costs from 15 to 20 shillings a dozen. The handles are usually $2\frac{1}{2}$ feet long, a longer one being inconvenient, though they are sometimes used up to $3\frac{1}{4}$ feet in the Spessart and eastern parts of the Black Forest. The use of these axes is spreading widely throughout Germany.

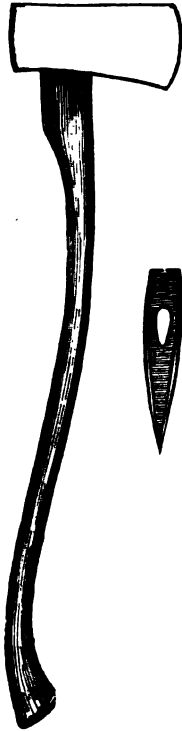

Fig. 65.—American
axe.

Two kinds of axes may be distinguished, viz.: the felling-axe, and the axe for cleaving or splitting wood.

(a) **Felling-Axes.**—The felling-axe is used for felling trees, chiefly large ones which offer considerable resistance to felling.

Only exceptionally do woodcutters use two axes, the felling-axe and the lopping-axe, and the latter is not required in broad-leaved forests.

The Saxon axe (Fig. 66) is quite straight-bladed from back to edge, and forms a complete wedge; the faces are slightly curved outwards, the handle is straight, and 0.75 meter (29 inches) long. The Harz axe (Fig. 67) is shorter, broader, and the faces hardly curved at all. The Bohemian axe (Fig. 68), also used in Moravia and Silesia, resembles the Saxon axe, but is bent downwards. The Carpathian axe (Fig. 69) is broader than those already described and is used also for splitting wood. The axe used in the Bavarian Alps (Fig. 70) is a light axe with a rounded back; the Black Forest axe (Fig. 71) resembles it, but is shorter, broader, and heavier, and owing to the large timber

common in the Black Forest, the handle is generally one meter (89 inches) long.

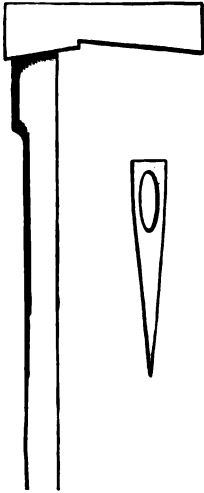

Fig. 66.—Saxon axe.

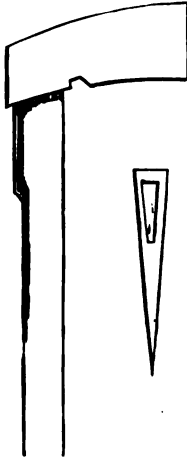

Fig. 67.—Harz axe.

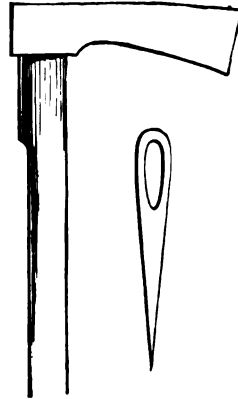

Fig. 68.—Bohemian axe.

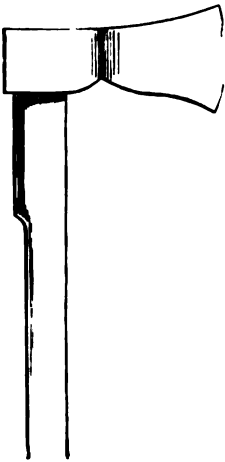

Fig. 69.—Carpathian
axe.

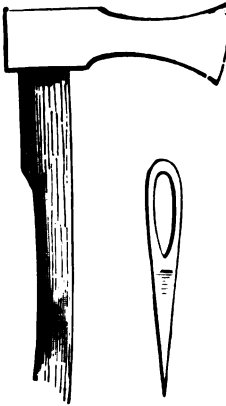

Fig. 70.—N. Alpine axe.



Fig. 71.—Black
Forest axe.

The lopping-axe used in the Bavarian Alps (Fig. 72) is similar to the felling-axe but is stouter, and heavier, and flat in the back.

In the same region the double-axe (Fig. 73) is used, which has a smaller head for small wood ; it weighs only 1.40 kilograms (3 pounds). The Thuringian axe (Fig. 74) somewhat

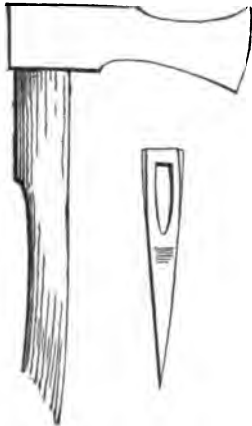

Fig. 72.—N. Alpine lopping axe.

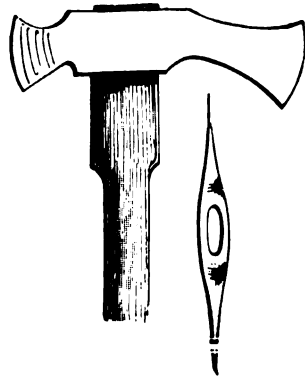

Fig. 73.—N. Alpine double axe.

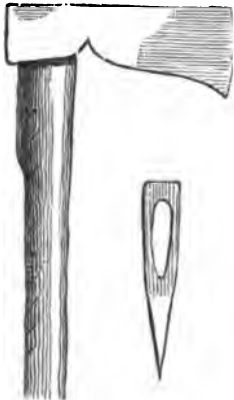

Fig. 74.—Thuringian axe.

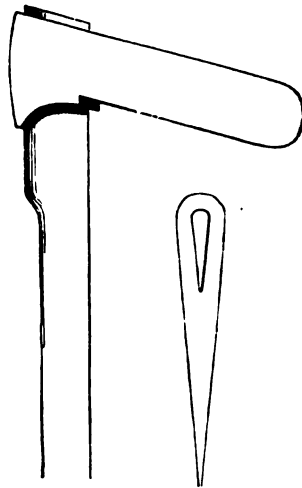

Fig. 75.—Norwegian axe.

resembles the Saxon axe. The characteristic shape of the Norwegian axe may be seen from Fig. 75 ; it is considered a very workmanlike instrument.

Figs. 76, 77, and 78 show French axes* with very light

* From Boppe, "Technologie Forestiere."

handles, they lighten the labour but render precision in cutting difficult. The Finnish axe (Fig. 79) is the lightest of all, and only 6 inches long so that half its weight is sheathed on the handle.

The main difference between the American axe and the

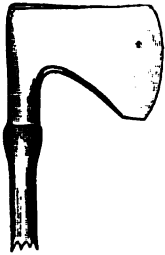

Fig. 76.—French axe.

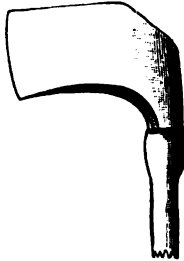

Fig. 77.—Breton axe.

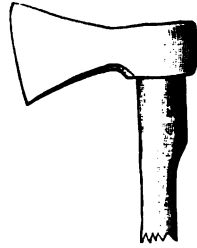

Fig. 78.—Lorraine axe.

various European axes consists in the devices for preventing its jamming and sticking in the cut. The faces of an axe are either provided along their middle line with a prominent ridge, or as in the Pennsylvanian axe (Fig. 65), are strongly curved outwards. The blade of the latter is made of compressed steel, hardly wears at all, and works well. By general consent this axe is considered to save labour and tire the men less than many German axes, owing to its convenient handle and freedom from sticking; it is used chiefly for softwoods. [The American axe is not, however, adapted for hard, tropical wood, for which the use of a narrower and lighter axe is advisable.—Tr.]

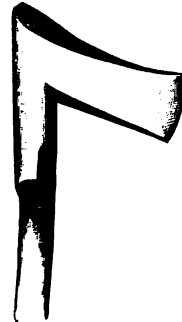

Fig. 79.—Finnish axe.

(b) **Trimming-Axes.**—The trimming-axe is used by woodcutters for trimming-off side-pieces of balks, and by the carpenter in preparing timber for building and other purposes. In Germany it is usually of the shape given in Fig. 80, having only one edge, the blade being curved inwards to allow sufficient play for the hand of the operator. The handle is short, usually $1\frac{1}{2}$ to $1\frac{3}{4}$ feet, and the workman uses it sideways from the side of the

log he is trimming. Another shape (Fig. 78) is in use in the Black Forest, being more convenient on rocky and difficult ground than the former.

[Trimming-axes in India generally are shaped symmetrically, but much larger and heavier than ordinary axes, weighing up to 8 pounds and more. The workman stands on the top of the log and trims-off side-pieces by swinging the axe vertically and merely allowing its own weight to act. The handles for

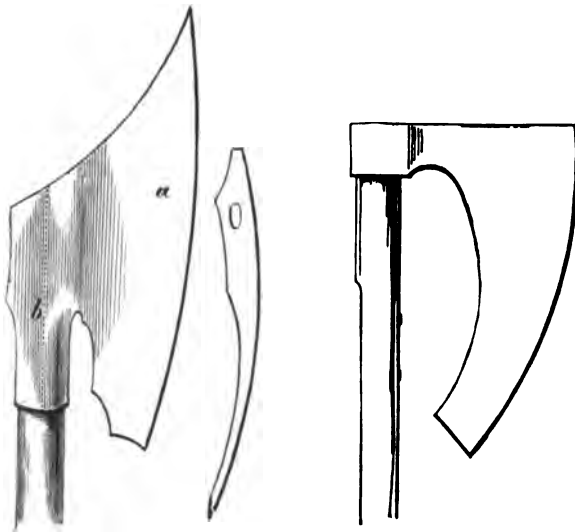

Fig. 80.

Trimming-axes.

Fig. 81.

these trimming-axes are $3\frac{1}{2}$ to $4\frac{1}{2}$ feet long so as to give sufficient momentum.—Tr.]

(c) **The Billhook.**—Billhooks may be of various shapes; they are used chiefly for cutting coppice or fascines, and in lopping branches from trees. Fig. 82 shows the common German billhook, the backward turn of the blade at its top being useful in pulling out the ends of withes while tying faggots. The English fascine-knife (Fig. 83) is 21 inches long and very serviceable in cutting fascines. Fig. 84 represents a very serviceable billhook; it is half an inch thick at the back, and has a cutting edge at *a* for cutting through branches placed on a piece of wood, as well as its ordinary cutting edge *b*.

Courval has invented a pruning billhook (Fig. 84) which is 16 inches long and weighs about $3\frac{1}{2}$ pounds; it is made thickest along its axis in order to add weight to its cuts. According to Courval all kinds of pruning, even of large boughs, may be effected with this instrument.

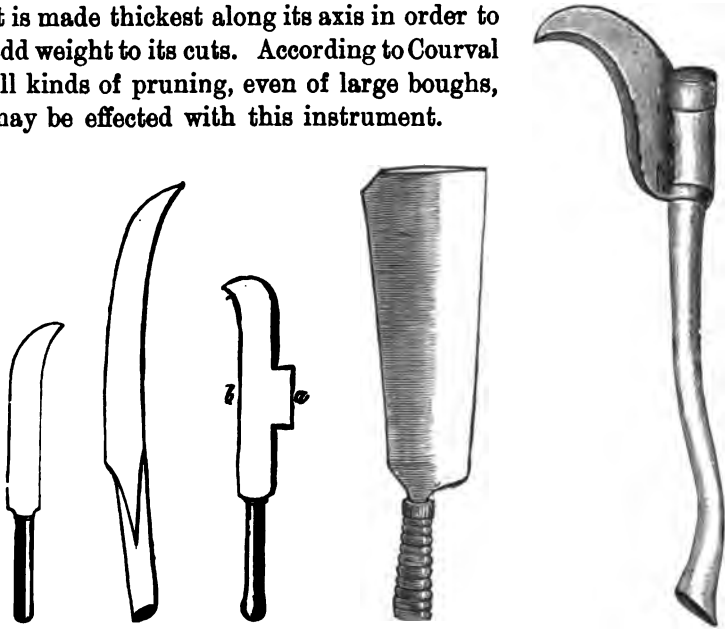

Fig. 82.

Fig. 83.

Fig. 84.

Fig. 85.

Fig. 86.

Forms of billhook.

Courval's tree-pruner. American thorn-hook.

The American thorn-hook (Fig. 86) is used for lopping; its head weighs $2\frac{3}{4}$ to 3 pounds.*

2. Saws.

(a) **General Account.**—Saws are used by woodcutters for felling trees, and for reducing the length of logs and branches at right angles to their axis. A saw may be used for such a purpose much more economically than an axe, which wastes much of the wood. Under certain circumstances and on difficult ground, the work may be done more expeditiously with an axe. The amount of time spent in sawing may vary from 20 per cent. to 40 and 70 per cent. of the whole time of the woodcutters on the felling-area.

* May be obtained from J. D. Dominicus & Sons, Remscheid-Vieringhausen.

Formerly forest saws were rolled out of wrought iron, and the rolled blade was then hammered cold to make it hard and elastic. At present, saws are made of cast steel, and work more easily than the older implements. Owing to the superior toughness of the steel they retain their edge and set better, and, owing to their smooth sides, they cause much less friction in use than the iron saws.

Saws have to overcome not only the resistance of the wood, but also the friction of their sides against the rough surface of the wood which is being sawn and the sawdust that collects between the teeth. Their teeth act chiefly by tearing the wood-fibres asunder*, and so much the more, the more porous the wood and the longer and tougher the wood-fibres; this is therefore especially the case with soft, broadleaved and coniferous woods. In the case of hard broadleaved woods, this tearing action is superseded partly by a cutting action. The more a saw tears the fibres apart the greater the amount of sawdust, which is therefore most abundant in the case of softwoods.

(b) **Mode of Construction of Saws.**—Saws are constructed differently according to the uses for which they are intended; they vary in **shape, length, weight, and shape of teeth.**

They may be used either for large or small timber. In the former case they cut both ways, are worked by two men and termed **two-handed saws**. In the latter case they cut only one way and are **one-handed**: such saws rarely exceed $1\frac{1}{2}$ to $2\frac{1}{2}$ feet in length, whilst the two-handed saws may be $3\frac{1}{2}$ to $6\frac{1}{2}$ feet long, their length being determined by the diameter of the piece to be sawn, and the distance through which the arm moves. The weight of a saw depends also on its length.

The construction of the teeth of saws varies considerably. Each tooth may be either symmetrical or unsymmetrical, and the teeth vary in depth, thickness and distance from one another, each of which points affects the working of the saw.

As regards the shape of the teeth, a distinction must be made between those cutting one or both ways. In the former case they are shaped usually as in Fig. 87, that of a right

* *Ibid* p. 115.

angled triangle, the shorter side of the triangle or face of the tooth being at right angles, or nearly so, to the line of their insertion on the saw. In English saws the hypotenuse, or back of the teeth, is cut-out in a curve (Fig. 88). Such teeth



Fig. 87.—Oblique triangular teeth.



Fig. 88.—Oblique socket teeth.

are used only in the case of one-handed saws, or in pit-saws used by woodcutters for sawing timber longitudinally.

Forest saws which cut both ways require teeth of a different shape. They are always symmetrical, and usually bounded by



Fig. 89.—Erect dog teeth.



Fig. 90.—The Harz saw.

straight lines: dog teeth, as in Fig. 89; curved teeth, as in Fig. 90, the Harz saw; or are so-called M teeth, Figs. 91 and 92, which cut both ways. American saws have teeth as shown in Figs. 93 and 94, in the latter, dog and M teeth are combined.



Fig. 91.



Fig. 92.

Simple M teeth.



Fig. 93.—Bevelled American teeth.

Space must be allowed between the teeth for the escape of the sawdust, which requires four to six times the space of the wood from which it is taken. This is provided by giving the teeth a much greater depth at *a b* (Fig. 95) than their cutting

edge *a c*, and by leaving a larger space between the teeth than their own area. In old-fashioned saws this was provided for by breaking-off the tops of some of the teeth at regular intervals,



Fig. 94.—American combined dog and M teeth.

as in Fig. 96, but such imperfect teeth are not found in modern saws. The dog teeth between the combined M teeth of American saws may be considered as planing-teeth for remov-

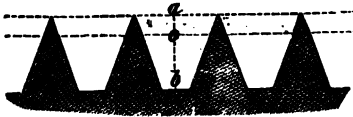

Fig. 95.—Saw with deep intervals between the teeth.

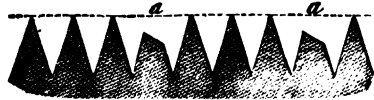

Fig. 96.—Saw with imperfect teeth.

ing splinters of wood, as they are not set like the other teeth. They may also serve as cutting teeth and then are sharpened.

(c) **Shape of Saws.**—Various kinds of saws have come into use in different countries, of which the following are the most serviceable:—

i. *Two-handed Saws.*

The two-handed forest saws comprise the straight, bow, and curved cross-cut saws.

The **straight cross-cut saw** is $4\frac{1}{2}$ by 5 feet long, with a



Fig. 97.—American saw.

breadth of blade of $4\frac{1}{2}$ to $5\frac{1}{2}$ inches. The handles are placed at right angles to the cutting edge of the saw, which consists of dog teeth with some shortened ones, and the blade is

slightly convex. They are used by Tyrolese and Italians to saw up railway-sleepers. Such saws are also used in broad-leaved forests, where there is much large timber, as in the Spessart and the Rhine Valley.

American straight saws, termed **Nonpareil saws** (Figs. 97

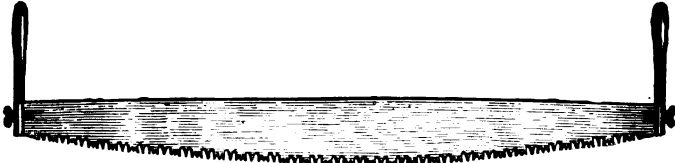

Fig. 98.—American saw.

and 98), from Disston & Sons, Philadelphia, are used now largely in Germany; experience shows that their outturn in broadleaved forests is 35 to 40 per cent. more than that of

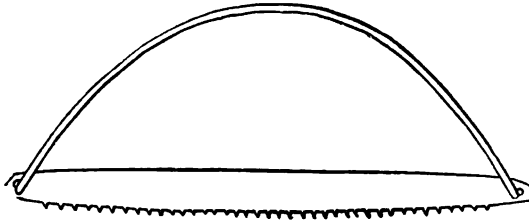

Fig. 99.—Harz bow-saw.

the ordinary straight German saws. In coniferous forests on the other hand, they have not proved superior to the Tyrolese curved saw (Fig. 101). The Nonpareil saw is made of



Fig. 100.—Bohemian bow-saw.

the best steel, and has an ingenious contrivance for fastening and removing the handles.

The **bow-saw** (Fig. 99), which partakes of the character of a straight cross-cut saw, has a straight thin blade, which is kept rigid by means of a bow. More exertion is required to work it than the other cross-cut saws, and it is serviceable only

when short. The width of the blade varies considerably. Fig. 100 represents the broad blade of the Bohemian bow-saw. The bow is made of a sapling of spruce, rowan or hazel, also of elm and ash; recently it has been made of metal, with tension screws. It is much used in North Germany, also in

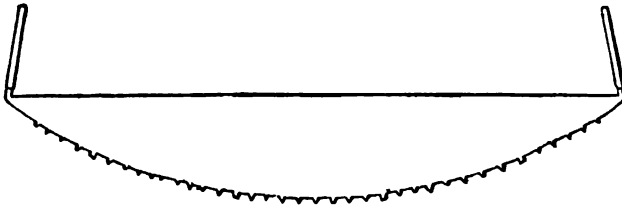

Fig. 101.—Tyrolese curved saw.

Bohemia, Moravia and Russia, but is not known in South Germany.

The Tyrolese curved cross-cut saw is constructed as shown in Fig. 101, and the dog teeth are often made longer in the middle than at the two ends, where they are less in use.

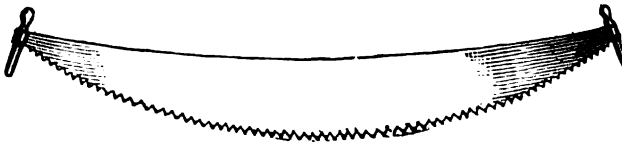

Fig. 102.—Thuringian curved saw.

These curved saws vary in length and curvature, and are either straight or slightly curved inwards at the back; they are extensively used.

The Thuringian, or Saxon saw (Fig. 102) may be taken as the type of a saw in which not only the edge, but also the back of the blade, is curved. It is a very light and short saw, but is strong and turns out good work. It is not suitable for very broad cuts, as when made long it is not stiff enough. In spite of this defect, it has, however, recently been introduced into several districts in the Black Forest.

K. Gayer and Kast* have tested the work done by cross-cut

* Gayer u. Kast. "Beiträge zur Ermittlung der Leistungsfähigkeit der Waldsägen," in Baur's forstwissensch. Zentralbl., 1896, pp. 417—478.

saws and according to their advice Dominicus & Sons have constructed an ideal saw, in their "Non plus ultra." This combines the advantages of the Tyrolese curved saw, with that

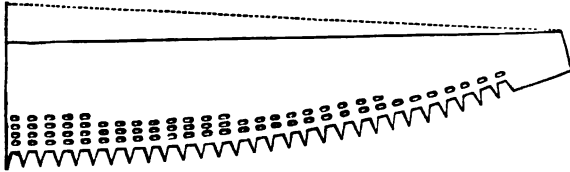

Fig. 103.—"Non plus ultra" saw of Dominicus.

of perforation of the blade (p. 191). Such saws vary in length from 4 ft. 2 in. to 5 ft. 10 in., and weigh 3 lbs. 9 ozs. to 5 lbs. 12 ozs. and are sold at 8s. 6d. to 13s. each (Fig. 103).

An important adjunct to all saws are the handles and the arrangements for fixing them to the blade. In the older saws, the blade terminates at each end with spikes, which are driven into the wooden handles. American saws have, however, a better device, the blade not being provided with spikes, but the handles fixed to it by means of screws and nuts, the former passing through holes in the blade, as shown in Fig. 104. This allows the handles to be removed readily, and the blade withdrawn from the cut; the blade can even turn on the handle, Fig. 105.

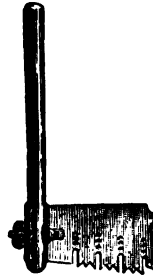

Fig. 104.

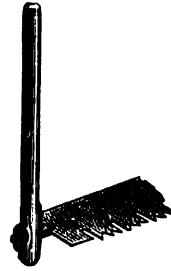

Fig. 105.

Removable saw-handles.

ii. *One-handed Saws.*

One-handed saws are used chiefly for removing branches and for pruning: pruning-saws have been described in *Manual of Forestry*, Vol. II., 3rd ed. p. 287. In one-handed saws the blade may be kept stiff either by a bow or by being made sufficiently thick. In bow-saws the teeth are oblique and their points are inclined forwards if the work is done with an upward stroke, or backwards for a downward stroke. Ahler's bow-saw (Fig. 106), has a removable blade arranged so as

to cut either way, with a bow that can be adjusted by means of a screw. [A frame-saw used in the North West Himalayas is shown in Fig. 107; the blade is of thin rolled steel and the teeth slightly set; it is kept stiff by catgut, which is twisted tight by the small piece of wood *a*.—Tr.]

One-handed saws without a bow are stiffened by increasing the thickness of the blade, that diminishes from the teeth edges towards the back of the saw; they are used for cutting poles or branches, and are called "Fox-tail saws."

Fig. 108 represents an American fox-tail

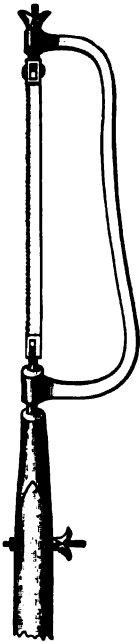

Fig. 106.—Ahler's bow-saw.

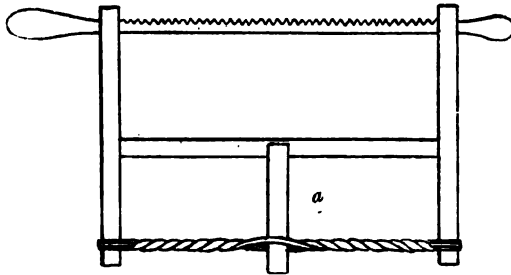

Fig. 107.—Himalayan saw. (After Fernandez.)

saw made by Disston & Sons, Philadelphia, for forest work. It is used for cutting logs of moderate thickness into lengths, and is very serviceable. It is constructed in lengths of $3\frac{3}{4}$, 4, $4\frac{1}{2}$, 5, $5\frac{1}{2}$, and 6 feet long, and costs 8s. to 10s.

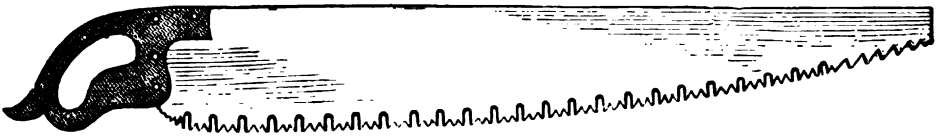

Fig. 108.

In using saws for cutting-up poles from thinnings or coppice the woodcutter improvises a sawing-block, on which he cuts up the poles into billets. This mode of sawing firewood is greatly preferable to cutting poles into lengths with the axe,

as it is more economical of the wood, and, after a little experience, is more labour-saving than the latter method.

iii. *Machine-saws.*

Attempts have often been made to fell trees by machine-saws, driven by steam or hand-power. Ransome's steam-saw, manufactured by A. Koppel, Berlin, as shown in Fig. 109, is the best known in Germany. Hitherto the use of these

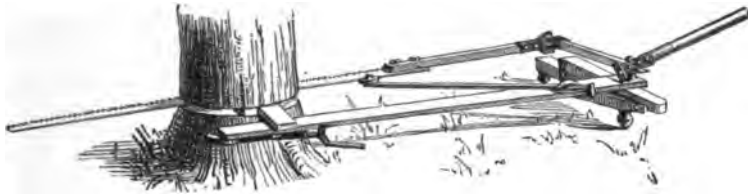

Fig. 109.

saws has not proved effective in European forests. In North America, where trees are either felled in the open, or wholesale in forests, without any care for the undergrowth, they may be serviceable: but chiefly the axe is used in the extensive Pacific Coast and mountain forests.

(d) **Mode of Using Forest Saws.**

This depends on the material of which the saw is composed, its shape, dimensions, curvature, weight, shape of teeth, amount of set or extent to which the teeth are bent to either side of the plane of the blade, their degree of sharpness, and, finally, on the kind of wood to be cut and the use to be made of the wood. The strength of the workman and his degree of skill in using saws are also important factors in the question, although it is difficult to estimate them.

The **material** of which the saw is made is so far important, as it determines its temper and how long it will remain sufficiently sharp and retain its set. Saws rolled out of cast steel are best in these respects.

As regards **shape**, curved saws are preferable to straight ones, especially for coniferous wood, and a radius of 6 feet

gives the most suitable curvature for general work. The Nonpareil saw is the best of the straight saws.

For practised sawyers, working with a curved saw is less fatiguing and the motion corresponds better with the movement of the arms than in using straight saws; the sawyer can also work in a more upright and less cramped position in the former case.

With a curved saw there is also more room for the sawdust, and the latter is less hindering to the work owing to the curvature of the saw (Fig. 110). It must, however, be admitted that the use of curved saws requires more skilled and experienced sawyers than that of the straight saw, for the curved saw is more liable to stick when the blade is not always working

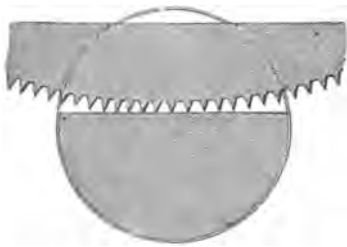

Fig. 110.—Cutting line of a curved saw.

in the same plane, a difficult thing to secure at first. The chief rule is to guide the saw lightly, and use no unnecessary force. In the case, therefore, of unskilled sawyers, such as men only occasionally employed in sawing, it is better to restrict them to the use of straight saws. For skilful sawyers, in coniferous forests, the curved saw only should be used.

As regards the length of saws, there is more risk of the blade bending and buckling (or sticking in the wood), if the saw be too long, while very short saws tire out the sawyers, and cannot be used with large timber. Lengths from $4\frac{1}{2}$ to 5 feet, with a breadth of $8\frac{1}{2}$ inches without the teeth, are the most effective dimensions for a cross-cut saw.

As regards the thickness of the blade, all saws should become gradually thicker away from the back, but the thickness should be only sufficient to prevent too great liability to bend.

As regards weight, saws should not be too light, or their use becomes very fatiguing, and $5\frac{1}{2}$ pounds is the best weight.

The construction of the teeth is of importance and dog teeth are most effective; M teeth, however, give good results

as shown by the "Nonpareil" saw. Triangular or dog-teeth should be $\frac{3}{4}$ inch high and $\frac{1}{2}$ inch wide. The spacing between the teeth should be double their width, and this suffices for coniferous as well as broadleaved wood. Wider spacing than this, by reducing the number of teeth, impairs the efficiency of the saw. The slit made in a piece of wood by a saw is termed the kerf.

The teeth are sharpened with a triangular file (better with



Fig. 111.—Sharpening of the teeth.

a two-faced one), and this should be done until the sides of the teeth that meet the wood are as sharp as knives. Saws which work both ways must have their teeth sharpened on both sides, but one-handed saws on one side only. As all forest saws are set, the stroke of the file must be always, as in Fig. 111, on the inner side of the teeth. When a saw has been properly sharpened, the tops of the teeth must not project above a general line, or the projecting ones will be broken. A good saw in constant use will require sharpening only every five or six days.

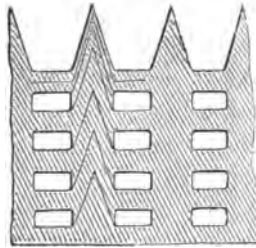

Fig. 112.—Perforated saw-blade.

It is highly important that the teeth should retain their proper shape, while constant use of the saw and frequent and



Fig. 113.—Perforated saw.

unskilful sharpening gradually alter it. Messrs. Dominicus & Son, of Remscheid, have introduced perforated saw-blades by which this defect may be remedied. Fig. 112 shows how this is done, and how the teeth drawn successively on the blade below the original set can be filed down gradually by the workmen,

as the original teeth become worn-out. Fig. 112 shows how the perforations are made in a straight cross-cut saw.

Saws are set in order that the blade may be drawn easily backwards and forwards in the wood without buckling; this is effected by forcing over the successive teeth alternately to the right and left of the axis of the blade. In order that setting may be effected properly, the metal must be sufficiently soft for the teeth to bend without breaking, but the blade must not be too soft, or the teeth will retain neither their edge nor their set.

By use, the teeth lose their sharpness and come back into



Fig. 114.—Key.

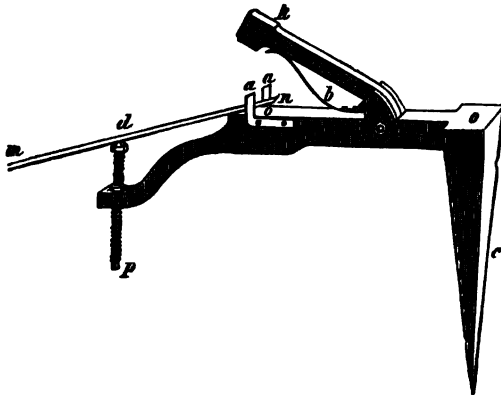

Fig. 115.—Barth's setting-iron.

their original position. The chief excellence of cast-steel saws consists in the fact that they retain their edge and set, much better than old-fashioned saws. If any of the teeth are too hard they can be softened by holding them for a few seconds between a pair of red-hot pincers. For setting the teeth of saws, a key, usually of the shape shown in Fig. 114, is used, the teeth being held in one of the grooves, and then bent over. Fig. 115 is a mechanical apparatus for setting the teeth of saws in a very regular manner. The blade *m n* (shown in section) rests on the adjustable screw *d p*, which may be raised or lowered, and on the anvil *o o*, so that the teeth pass successively between *a a*, and are bent by the hammer *k*. The apparatus is fixed firmly to a solid basis by the spike *c*.

Fig. 116 represents a mechanical saw-set by Blasberg of Remscheid, and Fig. 117 an American one by Morill; in both of them *a* is a bar which drives the teeth into position.



Fig. 116.—Blasberg's setting-iron.

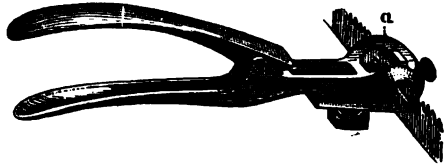

Fig. 117.—Morill's setting-iron.

A wider set is usual with softwoods than with hardwoods, and long saws also require a wider set than short ones. The

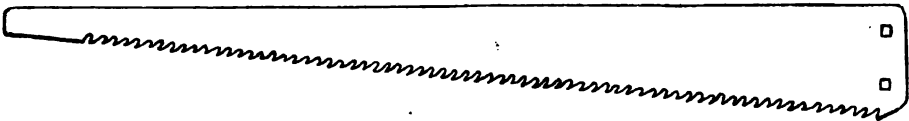

Fig. 118.—Pit-saw. (After Fernandez.)

set should never be more than double the width of the blade at the base of the teeth.

Recently in America saws have been much used with per-

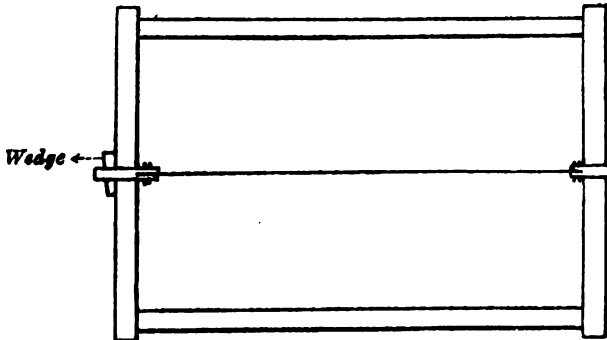

Fig. 119.—Frame-saw. (After Fernandez.)

manently set teeth, their thickness being greater than the blade of the saw.

The action of sawing is furthermore affected by the **resistance of the different woods**: this is greater in large pieces than in

smaller ones and for trees with knots than for even-grained wood; the degrees of resistance offered by woods of different species of trees to sawing have been already given (p. 114).

The measure of the work done by a saw is the surface sawn per minute, measured in square feet; a good cast-steel saw frequently will do three times the work of inferior saws, and thus will save labour considerably. In transporting saws, the teeth should be covered by a wooden sheath, both to protect them, and the transport employees.

[**Pit-saws** (Fig. 118) for longitudinal sawing are not so much used in forests as was formerly the case, owing to the fact that, generally, logs are removed in the round from forests and converted into planks, etc., in sawmills. Pit-saws are, however, used still in the Forêt Mormal, in France, for sawing curved oakwood for barges. Such saws also are used largely in Indian forests; also **frame-saws** (Fig. 119) which have very thin blades and are easily transportable, the frames being made in the forest. *In Indian saws also the teeth are filed so that the cutting edge is towards the operator, and much thinner blades can be used than when the saws cut in thrust as in Europe.—Tr.]

8. Tools for Splitting Wood.

For splitting wood and also for felling trees **iron or wooden wedges** and the **cleaving-axe** are required.

(a) **Wedges**.—Iron wedges have usually a wooden head, which is surrounded by an iron ring to prevent it from splitting (Fig. 120). Wedges may be made also entirely of iron, but they are then driven into the wood by a beetle or wooden mallet, whilst the wooden-topped wedges may be driven in with the flat steel back of a splitting axe.

Wooden wedges (Fig. 121) are prepared by the woodcutter out of tough middle-aged beech or hornbeam wood, and frequently are surrounded at the head by an iron ring.

Iron wedges are considered more serviceable for splitting tough wood; when wooden wedges are used, a cleft must be made previously in the wood with a cleaving axe. There is, however, a risk that iron wedges may spring out of the

* Fernandez, "Utilization of Forests," p. 86.

wood, the friction against their smooth sides being less than with wooden wedges; this happens not unfrequently with cracked or frozen wood. Sand or dry earth is placed in the



Fig. 120.



Fig. 121.



Fig. 122.

Iron wedges with wooden tops. Wooden wedge. Blessing's screw wedge.

cleft to prevent this, and a proper shape of the wedge renders it less likely to happen. Thus, if the sides of the wedge be flat instead of curved, or grooves $\frac{3}{4}$ inch broad and $\frac{1}{2}$ inch deep

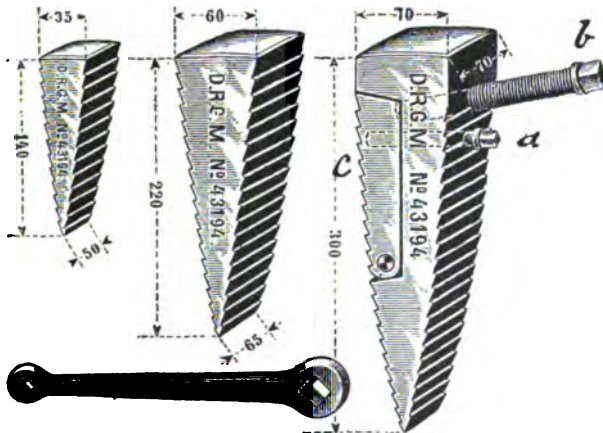

Fig. 123.—Schnücke's toothed wedge. Nos. are centimeters.

are cut in them, during use the wood is pressed into these grooves and the wedge thus firmly held.

Quite recently a screw wedge (Fig. 122) has been invented by Blessing for use while trees are being felled; this is held fast by the wood, but is not to be recommended.

Fig. 123 represents a toothed wedge, invented by Schnücker, which is used for forcing over a felled tree, or splitting tough roots, the wedge is driven in up to (a), the bolt (a) then removed and (c) forced outwards by the screw (b).

Small wedges are placed in the cut behind the blade of a cross-cut saw, to facilitate sawing.

(b) **Cleaving-axes.**—The cleaving-axe differs from the felling-axe by its superior weight, size and greater resemblance to a wedge. It weighs generally $4\frac{1}{2}$ to $5\frac{1}{2}$ pounds, or even up to 8 pounds in special cases, but resembles a felling-axe in

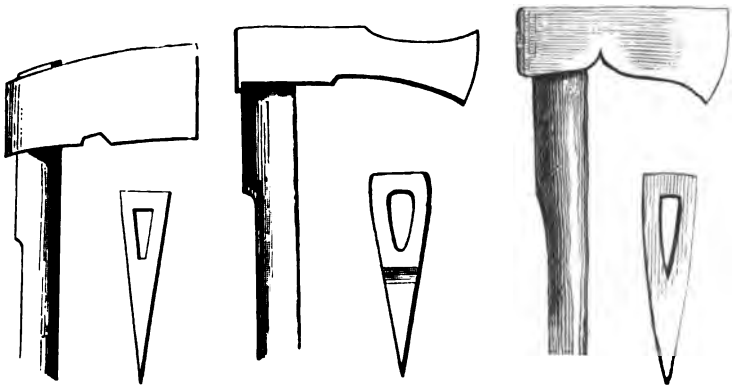

Fig. 124.
Harz cleaving-axe.

Fig. 125.
Tyrolse cleaving-axe.

Fig. 126.
Thuringian cleaving-axe.

shape, except that its back is flat, and made of steel, to render it more suitable for driving wedges into wood.

Fig 124 represents the cleaving-axe used in the Harz, it is two inches (5.5 centimeters) broad at the back, and weighs about $5\frac{1}{2}$ pounds. Fig. 125 is an axe used in Upper Bavaria and weighs about 5 pounds, its flat back is used for breaking off dead stumps from felled stems as well as for driving in wedges. Fig. 126 is the Thuringian cleaving-axe, and is very heavy. The Bohemian cleaving-axe (Fig. 127) has the stoutest shape of all these axes, and may be used for splitting firewood into the smallest pieces used for stoves. The Vienna cleaving-axe (Fig. 128) weighs up to 9 pounds. Fig. 129 represents an axe used in certain districts in Silesia, and is a good implement.

The divider (Fig. 337, p. 595) will be described as a tool used for splitting staves. Other tools and machines used for splitting firewood into small pieces in towns are not woodcutters' implements.

A method of felling trees by using a platinum wire heated

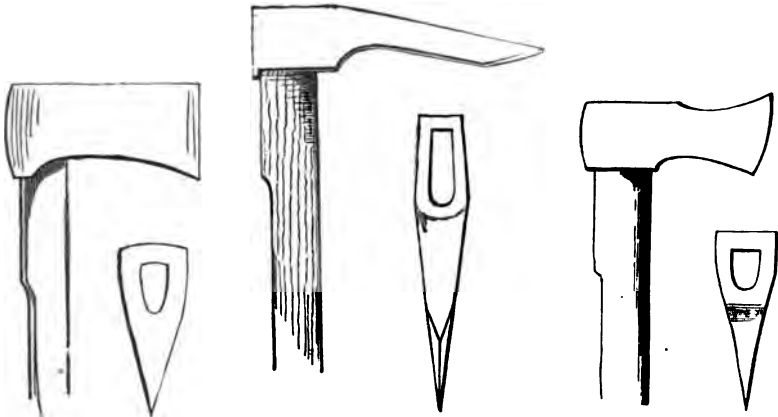

Fig. 127.
The Prague cleaving-axe.

Fig. 128.
The Vienna cleaving-axe.

Fig. 129.
The Silesia cleaving-axe.

to a white heat by electricity is described in *Le Jardin* for December, 1895. By its means the tree is severed more easily and rapidly than by the saw; no sawdust is made, and the slight charring produced by the burning wire preserves the wood. This method is said to be eight times as speedy as when a saw is used.

4. *Implements for Extracting and Splitting Stumps and Roots.*

Implements of a very simple nature are used in converting the parts of a tree which are above ground; those used for extracting and converting the stumps and roots are much more complicated.

(a) **Simple Grubbing Implements.**—The simplest tools used for grubbing-out roots are the **mattock**, the **pick**, the **pick-axe** and the **grubbing-axe**. Also short saws wedges, crowbars are

used for severing, removing or splitting the stumps and roots of a tree.

The mattock (Fig. 130) is about one foot long and 2 to 2½ inches broad, it is made of good steel and strongly fixed to its

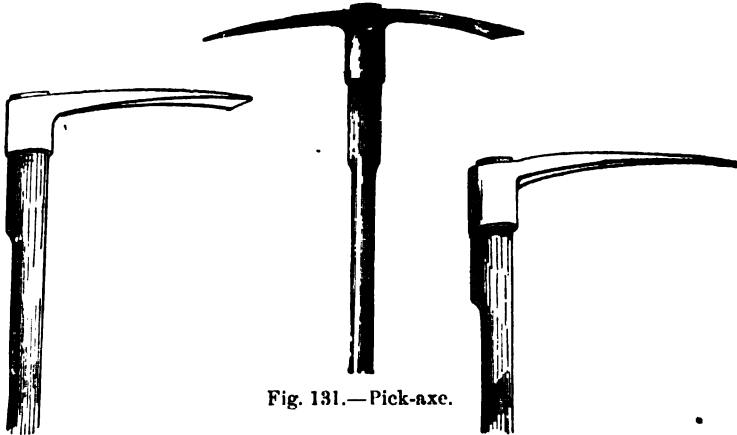

Fig. 130.—Mattock.

Fig. 131.—Pick-axe.

Fig. 132.—Pick.

handle and is used for digging into the ground and severing small roots. The pick (Fig. 132), which is sharply pointed, is used as well as the mattock for this purpose on stony ground, and both tools may be combined in the form of the common pick-axe (Fig. 131).

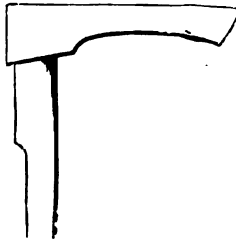

Fig. 133.—Bohemian grubbing-axe.

The grubbing-axe serves for severing the exposed larger side-roots, and is merely a small-edged felling-axe (Fig. 133); as, however, it wears out rapidly owing to the stones, etc., with which it comes in contact, usually a worn axe no longer serviceable for felling trees is used for the purpose.

In order to separate large spreading side-roots from the stump of a tree, generally a saw is used instead of an axe, and the ordinary carpenters' frame-saw is preferred.

Tough wooden levers, the size of a cart-pole, and 6 to 10 feet long, which are cut into wedges at one end, are used for

breaking up the side-roots after they have been separated from the stump. Besides these levers, wooden wedges of different sizes are used and their use will be explained further on with the operation of uprooting stumps.

A long iron wedge fitting over a wooden handle, the end of which is surrounded by an iron ring, is used also in separating deeply situated roots.

Fig. 134 represents a hook which fits over a tall thin coniferous pole; a rope is fastened to it by means of which, after the hook has been attached to a branch, a tree may be pulled over by the roots.

Sometimes the hook is fastened merely to a rope and may be attached to a branch by a man climbing the tree. This plan can be employed only in the case of tall slender stems, as climbing trees to attach the hook wastes too much time.

(b) **Machines for removing Stumps.**—In order to save much of the labour involved in using the tools just described for grubbing-out roots, various machines have been invented for the purpose. Of numerous modern inventions only the **Hawkeye machine**, the **forest-devil**, the **kant-iron and lever**, **Wohmann's machine** and the **screw-jack** will be described.

The **Hawkeye machine** (Fig. 135) consists of an iron vertical axle fixed on a firm support, moving in sockets placed above and below it, and surrounded by a drum *c*. This drum can be firmly attached to the axle, or loosened from it by means of the lever *b*. The axle with the drum attached is set in motion by a horse moving the shaft *a*, and thus a flexible steel rope 160 feet long which is attached at one end to the drum may be wound round the latter. The rope passes round the pulley *n*, which is attached to a powerful hook fixed to the stump *R* to be extracted, the other end of the rope is also attached by another hook to a support *C*. The distances, *A R*,

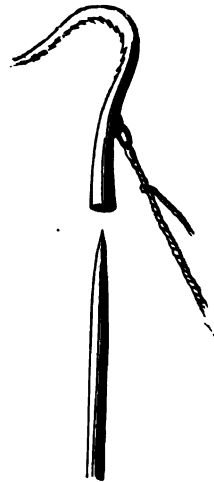

Fig. 134.—Tree-hook.



Fig. 135.—The Hawkeye machine.

R C, as shown in the figure, should be increased relatively from 6 to 10 fold.

The Hawkeye machine is extremely powerful, and not only pulls out the stump, but also the long lateral roots attached to it. It is especially useful in clearing woodland for agriculture, and may be used also for uprooting trees. In one day, with a horse and two men, 20 to 25 large stumps may be extracted at a cost of about 15 shillings. The machine may be purchased for £36 from Brandt at Munich, agent to the firm of James Milne & Son, Manticello, Iowa, U.S.

Another root-extractor is

termed the forest-devil, and has been in use from time immemorial in Switzerland and also for forty years in Germany. It consists, as shown in Fig. 136, of two strong iron chains, between which a wooden lever works. One end of

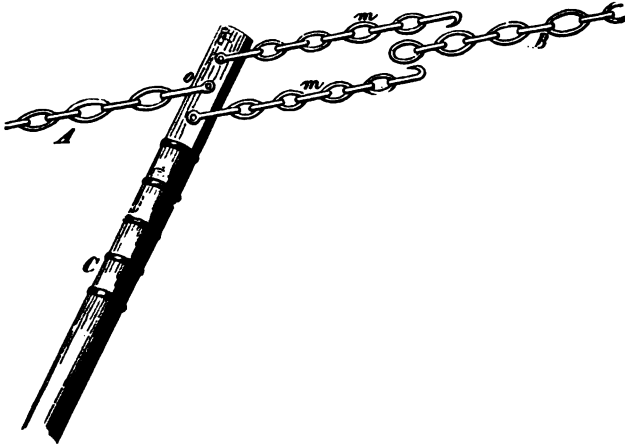

Fig. 136.—The forest-devil.

the chain *A* is fastened to a neighbouring strong root, stump, or tree, and the other is attached to the lever, at its fulcrum *o*. The second chain *B* is placed round the tree or stumps to be extracted, which must naturally offer less

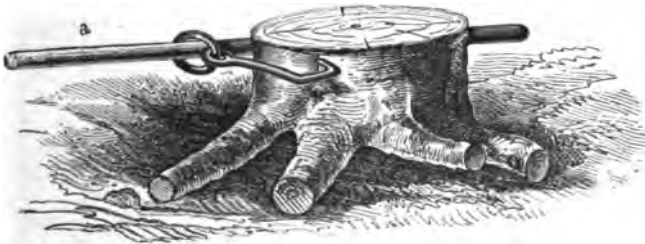

Fig. 137.—Lever and hook.

resistance than that to which *A* is fastened; it is connected with the lever alternately by means of two short chains each terminating in a hook. By then moving the lever backwards and forwards and hooking first one and then the other of these chains into links of *B*, the tree or stump may be extracted. *A*

strongropemay be used instead of most of the length of *B*, as long as there are sufficient links in the chain for working the lever.

Another method for extracting stumps is shown in



Fig. 138.—Lever and hook.

Figs. 137, 138, by means of a lever with a sliding ring and kant-iron or hook.

Wohmann's machine for pushing down trees is shown in

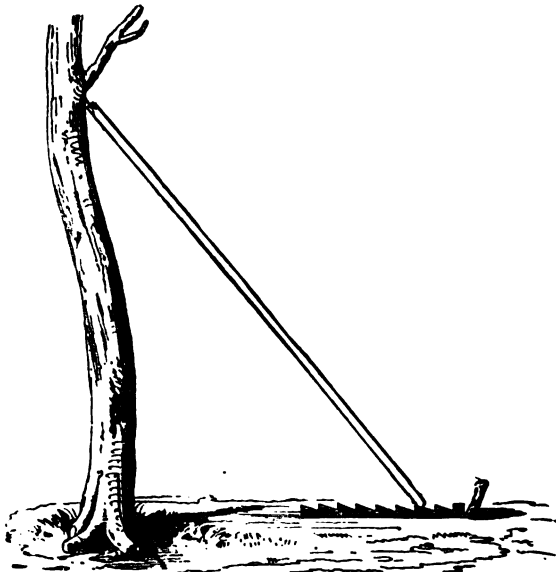

Fig. 139.—Wohmann's machine.

Fig. 139. It consists of a long coniferous pole with an iron spike at one end, and at the other end it is bored, as shown in Fig. 140, to admit a short iron bolt.

This pole is fixed into the tree and then the other end is placed on a grooved board and lifted from groove to groove by two iron levers. In this way the tree is gradually pushed over,

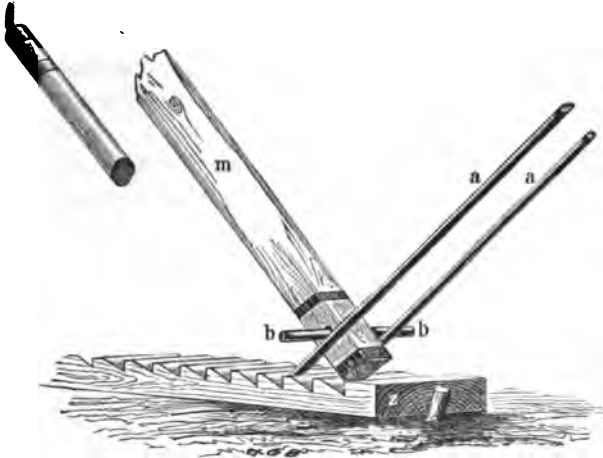

Fig. 140.—Wohmann's machine,

the action being most effective when the pole is at an angle of about 45° with the board.

The great weight, about 5 cwt., of this machine has pre-

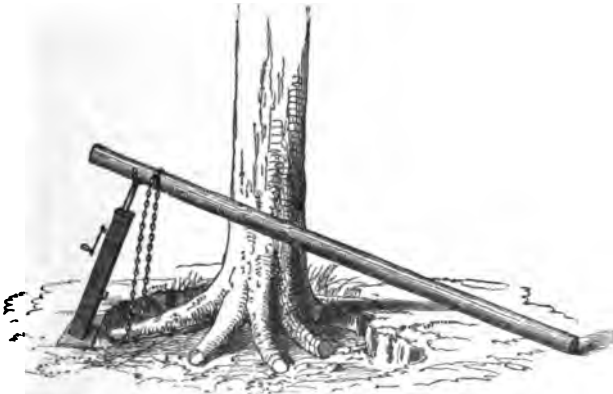

Fig. 141.—Screw-jack.

vented its coming into general use, but Draudt has constructed one of only half that weight, and Laubenheimer has substituted for the grooved plank an endless iron screw, on which a

car supporting the pole is moved forward by means of a winch, and he states that this gives 8 to 10 times the pressure of the original arrangement.

Ordinary screw-jacks (Fig. 141), are used also with advantage, as in the Schwarzwald, for uprooting trees and stumps. Recently, in Württemberg, a portable windlass has been used with good results both for uprooting trees and stumps, and for dragging loads of timber up steep inclines. Provided that the cost of working it is not too great, its use is to be recommended on account of its great power and adaptability.

[The *Déracineuse Lobo* used for extracting trees by the roots in Belgium is a gear of three legs on slides, by which it can be moved from tree to tree; also a system of pulleys and chains with toothed apparatus to be driven into the base of each tree. It is worked by six men and not only saves about £7 per acre in wood, and labour, including ploughing up the ground at £2 per acre, but enables the land to be planted up at once without any fear of the pine-weevil.*—Tr.]

SECTION III.—SEASON FOR FELLING.

The proper season for felling depends on several circumstances, of which the most important are,—the climatic conditions, available labour force, mode of felling, technical quality of the outturn, and species of tree, besides some other special points depending on particular cases.

1. *Climatic Conditions.*

These are in many regions the most important of all the circumstances which determine the season for felling; for where the winter is severe and the fall of snow heavy and lasting, so that outdoor work has to stop, as in most high mountain districts and in many localities only moderately elevated, forest work during winter may be impossible. In case fellings cannot be carried on during winter, transport by means of sledges, which is facilitated by the snow, may be effected. In high mountain regions, therefore, transport of timber and firewood is the chief occupation during winter. In plains and

* Cf. Report of proceedings of R. E. Arb. Society for 1906.

low hills the severity of winter rarely interferes with the work of felling, which is generally continued uninterruptedly during this season.

2. *Available Labour-Force.*

In most districts labour is more abundant in winter than in summer, when agriculture offers constant employment. In case, therefore, other stronger reasons to the contrary do not exist, forest management is interested in utilising the otherwise unemployed winter labour-force.

This is the more urgent, the more agriculture is the chief employment of the local population, which is not the case in extensive forests tracts, where the men work nearly the whole year in the forest, and do not care for other work, whilst the women and children cultivate the small agricultural area. If there are plenty of transport animals in such a country, carting is done chiefly during the open season, or whenever the roads are most passable (which in clay soils with unmetalled roads may be during frost); the timber may also be floated during the open season. In industrial countries, where factories abound, there is generally a scarcity of forest labour throughout the year, and especially in summer.

3. *Mode of Felling.*

On silvicultural grounds, as regards those modes of felling which are not concerned with reproduction, such as clear-cutting, the season is only of slight importance; it is more important when care for the woods is in question, as well as removal of some of the trees.

Clear-cuttings may be effected at any season of the year, unless they are to be followed immediately by sowing or planting.

Natural regeneration fellings, especially in broadleaved woods, must be effected when the fall and transport of the trees will do the least amount of harm to the shelter-wood and young growth, and that is in winter, whenever the ground is covered with snow.

Regeneration fellings among broadleaved trees, and especially secondary fellings on steep slopes, are effected best over a

deep layer of snow, in order to protect the young growth from damage during the removal of the timber. During summer, when vegetation is in full activity and tender shoots are injured so easily, broadleaved forests should be left alone; and the same rule should be applied also to coniferous woods with natural regeneration, unless the winter is too severe for fellings; but, even then, the period between the sprouting of the young shoots and their full development should be one of repose.

Thinnings in young woods are done best whilst the trees are in full foliage, and the best season for them is autumn. When, however, quickly grown, slender poles in a densely-grown wood are thinned late in the autumn, in exposed localities subject to breakage by snow or rime, they are very liable to be bent or broken; whilst, if the thinning be executed in spring or summer, they have time to become stronger and often to escape the danger. Whenever **injured trees**, broken by the wind or snow, or killed by insects, have to be felled, this is usually done in summer for broadleaved woods; but in coniferous woods the injured trees should be felled as soon after the damage as possible, unless some of the trees are used as trap-trees for beetles.

For **pruning** the branches of broadleaved trees, provided the wounds are tarred, autumn and early winter are the best seasons, but in the case of resinous conifers, pruning may be done at any season.

[Where tarring is not effected, February is the best month for pruning.—Tr.]

For **coppice**, late winter is the best felling season, for if the wood is felled early in the winter, it happens frequently that the stools are killed by the severe cold. Whenever, for certain reasons, autumn or winter foliage are necessary, the stools should be cut as deeply as possible in the ground. Cutting coppice during the period of vegetation gives rise to weakly coppice-shoots. [Standards over coppice cannot be felled till the underwood is cut and removed, and as oak trees are usually barked, this felling cannot then be done till May, when the bark peels easily.—Tr.]

Wherever stumps are to be extracted, this is done generally

during summer, and cannot be done at all when the ground is frozen.

4. *Quality of Outturn.*

As regards the influence of the season of felling on the quality of the outturn, the question has been discussed already (p. 102): it has been decided that the season has hardly any influence, provided the wood be thoroughly dried, but that the qualities of timber are affected greatly by the subsequent treatment of the felled material; when felled in winter, the material dries well in the subsequent spring and summer, winter-felling is therefore best, as there are usually six months before heavy rain. As a rule, broadleaved trees should be felled only in winter, and the same rule is desirable for coniferous wood, unless it can be removed from the felling-area and sawn up immediately after it has been felled; winter-felling is also best in the case of old and imperfectly sound trees.

Whenever climate is against winter-felling, the most valuable trees should be felled late in the autumn; this is the more essential, the greater delay there is likely to occur between the felling and the sawing up of the timber, or the removal of it to sheltered, airy timber-yards.

5. *Species of Tree.*

Conifers, and especially the spruce, are most liable to be worm-eaten; to protect them, the bark should, as soon as possible, be peeled from off the felled trees. Thorough barking is possible only in summer, whilst in autumn or winter the bark can be only partially removed; this, however, is quite sufficient to protect the wood from insects, and to allow of its thoroughly drying. If the trees are felled in autumn and partially peeled, the fact that the bark is left as a thin coating prevents the wood from cracking. [With ash, felling in sap, causes discolouration and consequent loss in market value, and clean, straight grained ash, *i.e.*, of the finest quality, is liable to split in all directions. Beech and sycamore also must be felled in mid-winter, as otherwise the wood splits and becomes discoloured, with dirty brown streaks. This is more important

with sycamore, as manufactured goods should appear in natural and unblemished whiteness. Both beech and sycamore are perishable timbers and any vestige of live sap contributes to rapid decay. Elm, when felled in sap, produces living branches with foliage, and such wood is nearly unsaleable for naves.—Tr.]

6. *Special Application of the Material from Felling-Areas.*

Exceptions are made when the material from the fellings is required for special purposes.

Thus, for bent-wood furniture, and for certain impregnation processes, and in the case of cloven wood, the trees should be felled in summer. If bark is to be used for tanning, the trees must be felled in the spring. Sometimes wood used for wells and water-pipes is felled during spring.

7. *Modes of Transport.*

As regards transport, it is found that wood felled in summer is lighter to carry and floats better than winter-felled wood; hence less firewood sinks, and the timber-rafts are less heavily laden, owing to the wood being dried much more thoroughly than when felled in winter.

8. *Demands of Timber-Market.*

The possibility of getting a good price for timber depends often on the time fixed for the timber-sales, and the latter on the time when the trees are felled. Where other considerations are not predominant, the felling period should be so arranged that the material may come to market at the season when the best prices are offered.

Thus, hop-poles and bean-sticks are felled best in the early winter, so that they may be sold before the spring. Timber merchants under contract to supply certain goods, such as railway-sleepers, etc., are bound to do so before a certain fixed date, and this circumstance will guide the forest-manager in fixing the time for his fellings.

Finally, it is easy to see that certain local circumstances,

such as accessibility of the ground, etc., may affect the felling period. Sometimes in alder-woods on swampy ground, the timber can be removed only when the ground is frozen. Where regular inundations occur during spring, it may be necessary to fell in summer.

[In the lowlands of N. India, during the monsoon (July-September), all fellings are stopped; the month of October is so malarious in some sub-Himalayan forests, that woodmen could frequent them at that period only at the risk of their lives.—Tr.]

9. *Summary.*

To summarise the above: it may be laid down that in localities with a mild climate, winter should be considered the normal season for felling; in high mountain-regions with heavy snow-fall and extensive coniferous forests, fellings should be made in summer, or better still in autumn.

Winter-felling occurs from the end of October till the end of March; it is the most natural period for the work, as the forest is at rest from vegetation, whilst the outturn is likely to be more durable and of better quality than summer-felled wood. Fellings cannot, however, be continued uninterruptedly during winter in the lowlands; deep snow may prevent the men from felling the trees sufficiently low down, and hard frost may render it difficult to split the wood and may injure the coppice stools, whilst much firewood is burned during the long, cold evenings by the wood-cutters.

As regards the distribution of different fellings during the winter months, usually seeding and secondary fellings in broad-leaved woods are commenced immediately after the leaves have fallen: the felling-area should be cleared before the seeds germinate, or the buds of the young growth sprout; in March this is often the case with beech. Wherever the logs are to be slipped down steep inclines and the workmen are not particularly trustworthy as regards protection of undergrowth, the fellings may be delayed till there has been a heavy fall of snow, or they should be effected in open weather, not during frosts.

Clear-cuttings in coniferous forests are not undertaken until

all the more urgent natural regeneration-fellings have been made, or are nearly concluded. Then also, thinnings or preparatory fellings in old woods may be carried out. Thinnings in young woods and cleanings end the series, and often are made during the autumn.

It is better to begin winter-fellings with the large trees and on felling-areas where these are numerous, then to proceed with the conversion of firewood. Supervision is thus facilitated, and the heavy pieces are soonest removed from the forest.

In very large forest-ranges richly stocked with old wood the manager may be satisfied if the more important fellings are done during winter, and in summer all wood worked-out that is broken by snow or wind or dead from other causes. Wherever summer-felling prevails, all the labour-force is engaged in transport during the winter.

Summer-fellings begin, according to the locality, in April or May, as soon as snow and frost permit and the labour-force which has been occupied in transport during winter is available. Where the men are engaged during summer in charcoal-making or other employments, or where, with a view to the quality of the wood, it is desirable not to fell the trees in full sap (July—August), these fellings should be suspended till September, and continued so long as the weather is favourable. Then the work is arranged so that reproduction-fellings and fellings of valuable timber-trees are effected as early as possible and may be finished before the buds shoot. The underwood is then highly elastic and suffers least from abrasion, whilst the logs can be barked and preserve their esteemed white colour.

Later-on, after the season of vegetation has commenced, firewood trees and other inferior sorts are felled, and the felling of whatever valuable trees were not felled before their sprouting will then be deferred till September.

In high mountain-regions where felling, conversion and transport cannot be completed during one summer, it is usual during the first summer and autumn to fell the trees, bark all the logs, prepare them for transport and remove them to the depots, after snow has fallen. The firewood is then

prepared in the second summer, carried down on sledges to the depots during winter and floated away in the spring. It is rare that more than two years are allowed for clearing a felling-area; in such cases the logs which have been lying so long in the forest rarely arrive at their destination in a perfectly sound condition, and they yield only inferior material.

Whenever great damage has been done by storms or snow, the first measure is to clear the fallen wood from the roads and ridges; after this has been done all trees which have fallen over young growth or poles are removed. When these cases have been attended to, woods where extensive breakage has occurred are cleared; then places where single trees have fallen or have been rendered insecure, all injured trees which may serve as breeding-places for insects being felled.

SECTION IV.—METHODS OF FELLING.

1. *General Account.*

As a rule, work is begun in as many felling-areas as there are gangs of woodcutters available, and care is taken to subdivide equally all immediately impending work in so far as the natural silvicultural sequence of the different modes of felling does not interfere with such a plan. This latter consideration is specially important in secondary and selection fellings, and in thinnings of mixed woods, which require great care on the part of the woodcutters and the constant supervision of the forest staff. Not unfrequently one gang may be distributed over several felling-areas, but when it is important to expedite the work owing to impending hard weather or heavy snow, several gangs may be employed in one felling-area.

In order to divide the work fairly among the men, the felling-areas, which have been previously marked-out on the ground, may be divided into as many equal subdivisions as there are parties in a gang; or in the case of secondary or selection fellings, or extraction of large trees over underwood, a certain number of trees may be allotted to each party of woodcutters.

Each subdivision of the work is numbered and termed a lot, and the parties draw numbers to decide in which lot they will work. In forming the lots great care should be taken that the

distance over which the material has to be moved is nearly the same in each case, so that all the parties may have about the same amount of work to do. The lots should neither be too small nor too narrow, or the men would be subject to constant interruption by those of an adjoining lot. On mountain slopes they are therefore placed side by side, running downhill. In such places it is often advisable to leave lots between two parties unallotted on account of the danger of accidents from falling trees, etc., work on these intermediate lots being undertaken subsequently.

Some lots may be reserved to be given afterwards to the most industrious men, whom the manager wishes to keep employed in the forest constantly. It is advisable to allow the woodcutters themselves to distribute the lots amongst the parties, so as to avoid all charges of partiality against the forest manager. The allotment in clear-cuttings in high forest or coppice is by area, lots being fixed by specially marking border and corner trees. Standards over coppice are marked with the forest-hammer or by rings of red or white paint, so must mother-trees in natural regeneration areas. In France each reserved standard is numbered, the numbers being cut into the bark by a special blazing implement. In thinnings each stem to be removed is marked by means of a tree-scratcher, or timber-scribe, or a forest-hammer may be used in the older crops.

As regards the actual felling, it is clear that silvicultural rules and those for giving the best outturn must be followed by the men, so that the felling may be conducted with a care for the trees and young plants which are allowed to remain on the area, that the felled material is not wasted, and labour is economised as much as possible.

Here will be considered the **different methods of felling trees**, their **relative advantages and disadvantages**, and the **general rules** to be observed in the conduct of fellings.

2. The different Modes of Felling.

The **different modes of felling** depend on the implements used: they may be further distinguished as;—utilisation of the stem, or of the roots and stump of a tree.

(a) Utilisation of the Stem.

i. *Felling with the Axe.*

The stem to be felled should be cut with the felling-axe in two places on opposite sides of its base (Fig. 142), as near the ground as possible. The wedge-shaped notches thus cut in the tree become larger and approach nearer the axis of the tree until the latter falls. These notches should be kept as small as is consistent with the easy admission of the axe, and should have smooth sides. As a rule, the height of the opening measured on the bark of the tree should not exceed its depth.

In order to throw the stem in any desired direction, the two notches should lie opposite to one another in that direction; the former one (*a*), (Fig. 142) on the side where the tree is to fall, should penetrate beyond the axis of the tree as deeply and horizontally as possible. The other notch (*b*) should be begun from four to six inches higher than (*a*), according to the thickness of the stem; it should be cut so that its

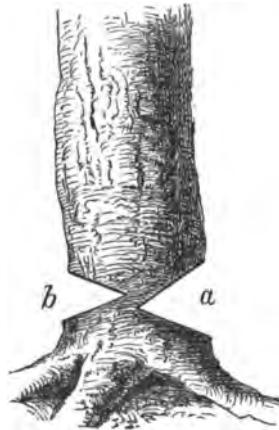

Fig. 142.—Felling with axe.
The tree falls towards *a*.

point extends above that of (*a*), or would do so if produced horizontally. If the stem is symmetrical it should be pushed lightly in the direction in which it is to fall. If its weight should preponderate slightly in that direction, that will naturally expedite the work; if, however, the weight preponderates on the other side, or towards either direction at right angles to that of the intended fall, a billet of easily-split firewood may be put in the notch (*b*), and several wedges then driven into it transversely, or between it and the edge of the notch, so as to press the stem over to the side on which it should fall.

In the case of valuable timber-trees, it is often advisable to cut them below the surface of the ground so as to save a portion of the stump as timber. In that case the notches are cut down

as deeply as possible, and often the earth is dug away all round the stump of the tree. It is then often insufficient in the case of large trees to cut only two notches, but cuts are also required at the other sides, though they should never be as deep as the principal notches in the direction of the fall. Small trees may be felled by one man, trees from 10 to 12 inches in diameter by two men working together, very large trees by four men.

ii. *Felling with the Saw alone.*

In the case of small trees, the saw-cut is commenced on the side opposite to that of the proposed fall, and continued until the tree can be pushed-over; in the case of large trees, owing to friction the sawing cannot, without some help, be continued beyond the axis of the tree; as soon as possible, therefore, two wedges are driven-in behind the saw, and as the sawing proceeds they are driven further and further until the tree falls.

iii. *Felling by means of Axe and Saw.*

The sawing (Fig. 143) is commenced at the side (*b*) on which the tree is to fall, and continued to about a $\frac{1}{4}$ or $\frac{1}{5}$ th of its diameter, and a notch in direction (*a*) is made with the axe to meet this saw-cut.

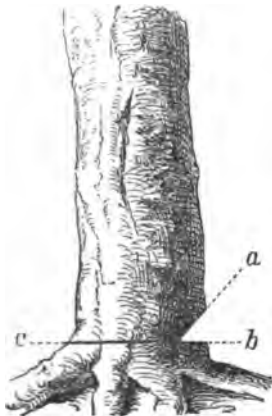

Fig. 143.—Felling with axe *a b*, with saw *c*.

The saw is then taken to the opposite side of the tree, and as soon as the cut (*c*) is deep enough wedges are inserted behind the saw, and from time to time driven further until the tree falls.

iv. *Felling with the Billhook.*

This is restricted to small poles, saplings and coppice-shoots, forming a dense growth in which there is no room to use the axe. Saplings are felled with one blow of the billhook, but if a stem is too thick for this, it should be felled with two blows on opposite sides, without making a regular notch.

v. *Felling by Means of an Electric Current.*

A thin platinum wire brought to a white heat by an electric current may be used as a saw for felling trees, the wire being stretched in a frame the handles of which are insulated. Experiments* have thus been made on a large scale, the stems being cut so deeply with the electrified wire that they can be thrown by means of wedges. It is said that this method takes one-eighth of the time required for sawing down the tree. No sawdust is produced and the slight charring preserves the wood.

vi. *Advantages and Disadvantages of the Different Methods.*

The characteristics of a good method of felling are, above all, that it is not dangerous to the workmen; that the tree is



Fig. 144.—Throwing a stem with levers.

thrown accurately in the desired direction, the most important silvicultural point in the felling; then, that it wastes as little wood as possible, and finally, that it involves the least possible amount of labour.

Experience has shown that felling by means of saw and

* Patent and technical bureau of Richard Bayer, Berlin.

axe combined, with the help of wedges, is the best of all methods, for in no other way can the tree be thrown in any desired direction so accurately, or is it less liable to splinter in falling.

Where the saw alone is used, several wedges may indeed be introduced, but the tree rests on one point of the circumference of the cut, and during the fall it frequently turns on its stump in a way which cannot be prevented by the use of wedges. If, however, a small notch is cut on the side of the fall, and the saw-cut opposite to this is opened-out by wedges, the stem when ready to fall rests, as shown in Fig. 143, not on a point, but on a straight line perpendicular to the direction of the fall, and any turning of the stem on its stump is an extremely rare event. A very simple and safe method has been long in practice in the Schwarzwald, as shown in Fig. 144; the pole *ab*, fitting into a notch in the stem at *a*, is lifted by two men by the horizontal lever *mb*, and is thus forced into the required direction. This is a simple form of Wohmann's apparatus.

The greatest waste of wood is involved when the axe alone is used for felling, and this not only because a considerable portion of the base of the tree is hewn into chips, which in mature trees may be 4 to 7 per cent., and in poles 2 to 2½ per cent., of the volume of the bole; but also because the end of the log remains pointed, and it cannot be used in its full length. Where the saw alone is used, there is least waste (about ½ per cent.), but even where both saw and axe are used the waste is small (1 to 1½ per cent.). There are, however, localities where working with the saw involves a greater loss than when the axe alone is used, and that is in steep rocky places where one is obliged to leave a high stump in order to work the saw at all.

The loss of bark in conversion is 4 per cent. of the prepared bole, for the beech and other smooth-barked trees; 7 per cent. for oaks and coarse-barked broadleaved species; 8—11 per cent. for the Scotch pine, spruce, and silver-fir; 15—18 per cent. for the larch and black pine.

As regards facility in working, this depends on the practice and skill of the woodcutters. We should compare only the labour of men equally skilled with saw and axe, and in

such cases there is very little advantage in using the axe alone.

Felling trees by means of axe and saw combined is, therefore, under ordinary circumstances the best method; it should be introduced everywhere, wherever custom still clings to the use of the axe only. It is impracticable only on steep rocky ground, and unsuitable in the case of very large valuable timber trees which should be cut out by the roots, also in thinnings in densely grown poles, where there is no room for sawing.

The disadvantages of the use of the saw and accompanying wedges must not, however, be overlooked. This frequently increases heartshake, a circumstance which deserves full consideration in the case of valuable timber trees: besides this defect, very tall thin stems, when half cut through, may split in two if the wedges are carelessly used; such a split often proceeds high up the stem. This disadvantage in the use of the saw depends, however, less on the method than on the carelessness of the workmen.

(b) Utilisation of Roots and Stumps.

This can be effected either by extracting the stumps of trees, or uprooting the trees.

i. *Removal of Stumps.*

Stumps are utilised by means of grubbing-axes, saws, wedges, crowbars, etc., or with the help of machines. The principal part of the work is that of grubbing-out the stump; this takes 70 to 90 per cent. of the labour involved in the whole operation. The work is commenced by digging all round the stump, and exposing all the side-roots as far as they are worth extracting. All these roots are then severed close to the stump and removed, the longer ones being severed at the thinner end as well. The workmen then continue to dig round the side roots, or the taproot, until their upper parts are exposed and can be severed, or extracted with the stump. Another way, after the roots have been exposed by digging, is to split the stump into pieces, and extract these

separately; for this purpose iron crowbars are used, or the stump may be blown up with gunpowder, as will be described further on.

It is evident that uprooting stumps is a most laborious process and attempts have naturally been made to lighten the work by using machines. These are all characterised by the attempt to tear the stump from the strong descending roots after the earth has been dug away, as previously explained. It is only in cases of small stumps and superficial rooting that digging can be dispensed with. Also where machines are used, they either tear the whole stump from the roots, or remove it piecemeal.

Wherever machines such as the forest-devil are used for uprooting stumps, all the side-roots should be cut off close



Fig. 145.—Removal of stumps by the forest-devil.

to the stump, except one large side-root which is left longer than the others, and serves as a lever for the attachment of the implement, as shown in Fig. 145.

Preference should always be given to the simplest of the implements which have been already described; although they only partially replace manual labour, yet they afford a simple application of considerable power. Experience has shown that the forest-devil is the best of the heavier implements. The Hawkeye machine is more powerful, and would be used in preference were its cost not so high.

Objection has been made to the use of the forest-devil, that it requires too many hands to work it, that it is difficult to fix the rope, and that the long lever requires much space to work in. These difficulties are not, however, so great as they would appear to be, if a chain is used instead of a rope and the roots are thoroughly exposed before working with the machine is attempted. Once this has been done, only three or four men are required to extract the stump; in Silesia the forest-devil has been found to save 83 per cent. of manual labour.

ii. *Uprooting Trees.*

When trees are uprooted (Fig. 146) much of the stump is obtained with the stem, in the same operation. The roots are exposed by digging, and then the stem is thrown in various ways, but in all of them a thorough exposure of the roots is essential. If all the horizontal roots are severed, the stem is attached to the ground by the taproot or main roots only. If, as with spruce on shallow soil, there are only

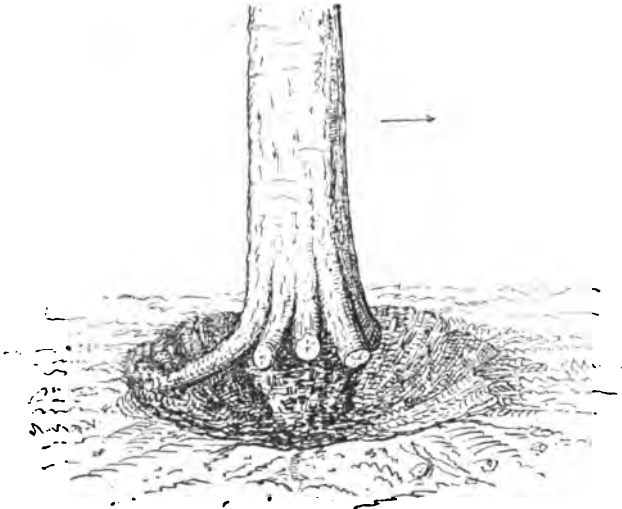

Fig. 146.—Uprooting a tree. (After Boppe.)

horizontal roots, merely severing these suffices to fell the tree; but wherever there are strong deep roots which it would be a most laborious operation to sever, the work is effected as follows:—A rope is fixed, as high up as possible, on one of the main branches of the tree, and on that side of it towards which the tree is intended to fall; a number of men then tug at this rope, and by alternately pulling and yielding, they make the stem oscillate backwards and forwards. One man is left at the base of the tree to cut through any roots which may still resist, and to place poles under the base of the tree as it rocks, and prevent its return to the vertical position. In

this way, without any great amount of trouble, the tree can be made to fall, tearing out at the same time all the stronger roots.

The forest-devil, Wohmann's thrust-pole and the common screw-jack, may be used also to overturn trees by the roots. The mode of using these machines has been explained already, but in the case of the forest-devil, a stem or stump stronger than the tree which is to be overturned must be at hand to be fastened to the implement.

All roots on the side where the tree is to fall must be cut close to the stem in order to lighten the work, and it is a good plan to place a round piece of wood under the falling stem, so that by its own fall the latter may the more readily tear its roots from the ground. [Coniferous trees 40—60 years old can readily be uprooted by the Lobo up-rooter (p. 204).—Tr.]

iii. *Advantages and Disadvantages of Uprooting.*

The advantage of utilising the stumps consists chiefly in the reduced waste of wood this involves ; for, on the average, one-fifth of the stem and branch-wood is contained in the stump. Stump-wood affords very good fuel, especially where a protracted steady heat is required ; the demand for firewood is, however, frequently so small that stump-wood has lost much of its importance in this respect. In highly populous districts, it may be the object of a forest servitude, or roots may be extracted for cultivation of the ground. In other cases, stump-wood is used for the horns of sledges, as knee-timber for ships and boats, for ploughs, etc. Extracting stumps is also useful, as by afterwards levelling the holes, the ground becomes thoroughly cultivated and suitable for sowing ; for not only is germination facilitated, but in dry soils the young seedling-plants thrive best on the deeply worked soil of these holes, provided care is taken to protect them from weeds. [Oak-standards over coppice in France are always uprooted, as the wood is thus less liable to crack and a valuable piece at the base of the log is saved.—Tr.] Stumps are frequently breeding places for destructive insects, especially of the Pine-weevil ; they also shelter mice, so that their removal is

beneficial. That most destructive fungus, *Armillaria mellea*, also spreads from stumps into new plantations.

There are, however, certain disadvantages involved in the removal of stumps; in the first place, decayed stumps increase the humus and mineral matter in the soil. This may not be of importance where the humus is carefully preserved by maintaining the leaf-canopy and preventing all removal of litter, especially on damp soils. Where, however, these conditions do not hold good, as for instance on poor sandy soil where the litter is removed, if the stumps are also extracted and the soil deprived of its last resource in organic matter, it may thus be rendered absolutely unproductive. **Secondly**, on steep slopes, wherever it is essential to hold the soil together as much as possible, in order to prevent denudation, extraction of stumps should be prevented.

Extraction of stumps is, therefore, permissible wherever it can be done remuneratively, provided that no serious damage is done to the standing-crop, as for instance by extracting stumps of large reserved trees among poles or saplings, or of mother-trees among thoroughly stocked natural regeneration. It is advantageous:—wherever there are blanks and gaps in natural regeneration, even in coppices, provided the loosening of the soil which accompanies the extraction of the stumps causes no local damage by floods, or on steep slopes by landslips or avalanches; wherever there is no fear of exhausting the productiveness of the soil, and wherever it is wished to prevent damage by delinquents extracting the stumps, or by insects, fungi or mice.

The question now arises whether it is better to extract the stumps or to fell the trees by their roots. There has been much discussion regarding this, but there can be no doubt that **uprooting trees is preferable**. By this method, much wood which would otherwise be wasted, or become merely firewood, is kept on the stem, and the roots are extracted not only more easily, but also more thoroughly. Stems uprooted also fall more lightly on the ground than felled trees; so that there is less breakage and damage done to young growth, and the roots attached to the stem are converted more easily into smaller material than in the case of a stump.

As regards the gain in timber, it is evident that a considerable and often highly valuable addition is thus made to the largest log in the tree. This may amount to 8 to 10 per cent. of the timber in the stem. All windfalls are in this condition, and generally fetch good prices.

Also it can be shown easily that uprooting trees is a less laborious way of utilising root-wood than the method of extracting the stumps; for it is clear that in both methods the earth must be dug away from the roots, whilst the only advantage of the machines is to save a certain percentage of the manual labour, which must be employed in extracting the stump. When, therefore, nature offers a lever in the tall stem of the tree firmly fixed to the stump to be extracted, its effect can be replaced by no combination of machines, so that it is mere folly to expect better results from the latter. The stem itself tears from the ground a number of small roots which could have been dug up only at a cost quite disproportionate to their value. It is also always easier to separate the stump from the stem, after the tree has been felled, than while it is standing. According to experiments carried out by R. Hess, there is a gain in time and labour of 20 per cent. in uprooting trees instead of felling them and then extracting their stumps.

The advantages thus described of uprooting the trees are sufficient to counterbalance entirely the alleged disadvantages of the method. It is stated, for instance, that the tree cannot thus be thrown with certainty in any desired direction, but by using a thrust-pole, or a rope, and severing carefully any resisting roots while the tree is falling, it can be thrown quite accurately. Another objection is made, that frequently the falling stem tears-up a large mass of earth with the roots, a statement often made erroneously and in any case not sufficiently objectionable for the uprooting of trees to be abandoned. A larger hole is often made by grubbing-out the stump than by uprooting the tree. It is alleged also that uprooting trees seriously delays the felling operations. The sub-aërial part of a tree is clearly utilised more quickly by the use of axe and saw than by uprooting the tree, but if the subterranean part is required as well, there can be no advantage

in setting to work on the felling-area a year after the trees have been felled in order to extract the stumps.

Whilst, however, in general it is preferable to uproot the trees, cases occur where grubbing-out the stumps is necessary or permissible; as for instance where felling is urgent but the ground is frozen, and in forest clearances, when there is no urgency for extracting the stumps. It is always pre-supposed that extracting stumps is done by the aid of implements, for when this is done by mere manual labour, it is the most tiresome and dilatory mode of utilising the roots of trees.

[Wherever a clearance is to be effected for a forest-road, or ride, or for the site of a nursery or forest-house, etc., it is always better once for all to uproot the trees standing on the area. This is especially the case in India where buried stumps are attacked by termites and a dangerous place to traffic results.—Tr.]

3. *Felling Rules.*

Partly as regards care for the forest growth, partly to increase the quantity and value of the yield, and partly to economise labour, the following rules should be observed by woodcutters.

- i. **The woodcutter must always endeavour to throw every stem, so that by its fall it will do the least amount of damage to the forest growth and felled timber around it.**

The attention of the woodcutter in this respect is particularly necessary in the case of the final stage in shelter-woods, selection-fellings and in all reproduction-areas, and wherever large trees standing over poles or saplings are to be felled.

In order as fully as possible to carry-out the rule, the directions of the forest officials should be followed closely, so that the young growth may be injured as little as possible. To secure this object, it may be necessary to **lop all the branches** from large trees before felling them.

The skill and attention of the woodcutters are nowhere put to such a test, as in the removal of large trees from over poles

and saplings in the natural regeneration-fellings under the group system. The more susceptible to damage the young crop, the most careful should the woodcutter be, and the more

important it is to effect such fellings gradually, that is to distribute them over several years, and to choose a season for the felling when the young growth is least brittle and least liable to damage by the unavoidable accidents contingent to fellings: in any case such fellings must never be undertaken during frost.

Secondary fellings over young seedlings are also highly dangerous to the young growth, and should be effected only when sufficient snow is on the ground to protect the plants.

The lopping of branches from standing trees may secure several objects. It sometimes assists the fall of a tree in a certain direction to lop the branches from the opposite side of the tree, but the chief reason for lopping the branches is that the tree in its fall may do as little injury as possible to the young growth.

Whether this lopping is necessary or not depends on several circumstances. In the first place, it must be remembered that it is not the stem, but the crown of the tree which may do serious injury to the young plants. If, therefore, it can be arranged to throw a tree with its crown on a blank unstocked with young growth, there is no need for lopping its branches. In such cases several

trees may be thrown with their crowns on the same blank. Lopping the branches of a tree is dangerous, and men capable of doing it are not always available, so that the forester



Fig. 147.—Removing top of tree. (T. H. Monteath.)

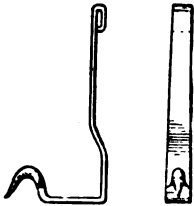

Fig. 148.—Climbing-irons. (After Boppe.)

will if possible avoid the practice. In certain regions, as in France, the Black Forest and many Alpine forests, experienced climbers who mount the trees with climbing-irons (Fig. 148), may be found ready to do the work, on account of the high rate of remuneration. Wherever a coniferous tree standing over a group of young conifers is to be felled, first its stem should be cleared completely of branches, and the narrow alley it makes in the young wood will soon become closed. This is especially desirable in coniferous forests, for injured advance-growth is very liable to insect attacks.

Lopping the heavy boughs of broadleaved trees standing in the midst of young growth may injure the latter, whilst the entire crown might fall beyond it, and in any case not injure the plants so much as do the separate boughs.

[The branches and top of very tall oaks and beeches are, however, lopped in France, in order to prevent their long valuable stems, which are much lighter without their lofty crowns (Fig. 147), from cracking in their fall.—Tr.]

Valuable little stems in pole-woods may often be bent back, or tied back by withes to allow for the passage of the falling stem. It is, however, an error to be too anxious to prevent damage to young growth in a felling, for everyday experience shows that what appears to be serious devastation is no longer noticeable after a few years. Even where a valuable standard tree standing over large poles has become mature, no hesitation should be shown in felling it.

- ii. **Each stem should be thrown in such a direction that it does itself the least amount of harm.**

As regards the direction for felling on slopes, the danger of breakage is much lessened by throwing the tree uphill, as then its summit describes the smallest arc and attains the least velocity on reaching the ground. Therefore, in felling valuable tall timber trees, it is better to fell uphill. On very steep slopes it may be advantageous in the case of firewood trees to throw them with the crown downhill, so as to prevent the tree from sliding any further.

[In the Himalayas, however, the plan of felling uphill was abandoned in steep places owing to the danger this caused to

the woodcutters, the base of the tree often shooting out backwards or sideways from the stump. This danger may be avoided by felling sideways, on to a contour line, if the men stand above the tree at the moment of its fall.—Tr.]

In order to prevent the stem from breaking, the configuration of the ground on which it will fall should be inspected carefully, as felling across gullies, on to rocks or other stems may break the tree. In the case of valuable timber, where there is an object in securing as long and straight pieces as possible, or where valuable curved wood is being felled, great care must be taken not to throw the tree on to stones or frozen ground; therefore felling valuable trees should be stopped during a hard frost.

In such cases a soft bed of branches or faggots may be placed under the trees, on to which they should be felled; or they may be felled against a neighbouring standing tree, provided that it is also to be felled. A tree may be felled, so as to fall slowly, by forcing it over by means of wedges before it is completely severed from the stump. Where a tree is not too tall, it may preserve the lower part of the stem from breakage to fell the tree without previously lopping any of its branches.

iii. In felling timber-trees, attention should be paid to easy removal of the logs.

Trees should not, therefore, be felled across or into ravines, but, provided rules i. and ii. are observed, into such a position that their removal may be effected easily.

Long stems are most easily removed downhill, when they lie along the slope of the hill with their thicker ends downwards, and this position is secured by throwing them uphill.

iv. During a strong gale, felling operations must be suspended.

This should be attended to, at any rate, wherever the direction in which the trees will fall is of importance, for then the woodcutters are no longer able to guide the trees.

The wind is the woodcutter's worst enemy, and it is usually

during a gale, which prevents the men from hearing what is going on around them, that most felling accidents happen. In felling a tree, the woodcutter is safest near the stump and at right angles to the direction in which the tree will fall; the most dangerous place in felling uphill is behind the stump, as already explained, especially in the case of crooked trees.

- v. **Great care must be taken that no trees intended to form a shelter-wood, or to be left standing for any reason, are injured by the fall of the trees marked for felling.**

If such an accident should happen, a few marked trees should be left unfelled from which the forest-manager may choose substitutes for those injured. This should be done also in case windfall or theft has removed any of the selected shelter-trees. Poles or saplings bent by the felling should, if possible, be set straight, or if too much injured for that, should be cut-back level with the ground, with a sharp instrument.

When a tree falls out of the proper direction, it frequently happens that it rests or remains hanging on another tree. Such a tree usually may be brought to the ground by cutting it away from its stump, to which it is often still attached in such cases; or one or two short logs may be cut away from its base; or use may be made of the screw-jack to release it. If, however, no other means of releasing it are available, a man must climb the trees on which it is resting and lop off the branches which impede its fall.

[In tropical countries, where large lianes abound in forests, these should be severed near the ground, two years before felling, so that the stems of the lianes which frequently enlase several trees may become rotten before the felling takes place; otherwise a whole group of trees may have to be felled at once, if it is desired to fell any of them.—Tr.]

- vi. **Trees exceeding 6 inches in diameter, chest-high, should be felled always with the saw and axe; smaller trees and very large trees may be felled with the axe alone.**

In all cases the cut should be as near the soil as possible, and, as a rule, the height of the stump should not exceed the

third of its diameter, or say one foot for large trees and six inches for small ones. Exceptions, however, occur to this rule: thus in the Harz, stumps three feet high are left, as they make the best charcoal for blast-furnaces; in other places forest-rights compel the managers to leave high stumps. [Mahogany and other tropical trees which have large buttresses rising from the roots are felled by erecting platforms above these buttresses.—Tr.] Wherever the trees are uprooted, care must be taken that this is done thoroughly, so as to save all rootwood over $1\frac{1}{2}$ inches in diameter, and the holes made in the ground must be filled again carefully.

vii. **Wherever coppicing is effected, only the axe or billhook and not the saw should be used, in order that smooth surfaces not liable to decay may be left to the stools.**

The cut surface should be quite smooth, and the stools must not be split, nor the bark torn from them; poles and saplings therefore must not be bent over by the woodcutters whilst they are being cut, and every woodcutter must use sharp tools.

In the case of all trees which reproduce by suckers (elm, white alder, lime, aspen, common maple, hazel and most willows) and of those which shoot out from collum-buds, provided the stools are not very old, the cut should be as deep into the ground as possible. In this way the shoots will come out close to, or even below the surface of the ground, and will produce new roots for themselves, and thus new stools will be formed. The beech, on the contrary, shoots high up on the stool; for beech, therefore, for alders in ground liable to inundations, and for birch on poor soil, each successive felling must be made slightly higher than the previous one.

The yield of a coppice is maintained only by preserving the strong old stools; young seedling plants do not compensate for the death of these. Old stools may be kept productive for long periods, if they are cut somewhat higher at each felling. If stools get covered with moss and knobbed, they may be left up to six inches high in the case of beech and other species which do not produce suckers. Oaks and hornbeam, as a rule, are least sensitive to bad coppicing. In the case of pollards, the cut is raised slightly at each felling.

- viii. Woodcutters, as a rule, should not fell more trees than they can convert and remove in the next three or four days.

This tends to facilitate order and supervision, and also to economise labour, for otherwise not only would they have insufficient space in which to work, but also encroach on the space of neighbouring parties, whilst the removal of the wood would be delayed till all the felling was over. Only in the case of thinnings or clearances should all the trees first be felled and then converted into marketable sizes. [Also in selection-fellings and where the trees to be felled are far apart, as in Deodar forest in India, when all the trees may be felled and afterwards converted.—Tr.]

- ix. Whenever there is fear of damage by insects or fire, the woodcutter is bound to clear away all wastage of broken branches and twigs from the felling-area.

Wherever the brushwood cannot be otherwise utilised, as in remote mountain-forests, it should be collected in heaps, leaving room between these for the removal of the timber. After the felling is over, the brushwood is often spread over the area to protect the young growth from frost, heat, and cattle, or it is burned.

- x. Wherever breakage has occurred, owing to wind or snow, the work of felling should commence on the side of the prevailing wind and proceed in its direction.

Clearing extensive areas covered by windfalls is often a most dangerous occupation for the woodcutter. Trees crossing one another and wedged together can be separated only with the greatest difficulty, whilst when a stem has been cut from its roots and the attached ball of earth, the latter may suddenly turn over, and accidents can be avoided only by great care and attention on the part of the woodcutter.

SECTION V.—ROUGH CONVERSION OF WOOD.

By rough conversion of wood is meant the woodcutter's work of dividing felled trees into pieces of dimensions suitable

for transport. Any further preparation of the wood into marketable pieces is usually the work of the timber-merchant, or middle-man.

No part of the work on the felling-area is more important than rough conversion, or requires greater supervision and care on the part of the forest-manager, for it has a very great influence on the forest revenue. In order that a forest may be managed so as to satisfy the demands of its owner, as well as of the neighbouring population, it is necessary in forestry, as in all other branches of industry, that every endeavour should be made to utilise the raw material completely and in all possible ways, and thus meet the actual requirements of the public. The trees therefore must be converted into timber from an entirely mercantile point of view.

As a last resort, all timber can be used as firewood; whenever then it is fit for fuel only, the business of conversion is reduced to the simple operation of preparing the usual sorts of firewood.

Since, however, in most districts the value of firewood has of late years been greatly reduced, and a revenue can be obtained from many forests only by sale of the timber which they produce, the most important point here is the conversion of the latter. The chief rule is, therefore, to produce as much timber of good quality as possible, and in order to attain this object thoroughly, a forester must have a certain knowledge of the requirements of the different industries where wood is used.

The Wurtemberg rules for the conversion of wood are excellent. (i.) The outturn of timber as compared with firewood should be as large as possible. (ii.) All the material from a felling should be converted so as to produce the highest possible pecuniary return. (iii.) All logs should be as long as possible. (iv.) Sound timber should be separated from all that is of doubtful quality. (v.) Defects should not be concealed. (vi.) The converted wood should have a good external shape.

The subject will be dealt with as follows:—first, the circumstances which decide on the mode of conversion to be applied; then the usual assortments of timber and firewood and the work of conversion by the woodcutter; and, finally, the general principles of rough conversion.

1. *Mode of Conversion to be Applied.*

The mode of conversion suitable to any particular felling-area depends on the **adaptability of the wood and the demand for it.**

(a) **The Adaptability of the Wood.**

This varies with the species, form, dimensions and quality of the wood.

i. *Species of Wood.*

The uses of the different kinds of wood will be discussed in Chapter VI. ; it will be shown that conifers are used chiefly as timber and that, of broadleaved species, it is the light-demanding trees, and, above all, the oak, which yield the most valuable timber.

The following remarks refer to the usual forms of woods met with. Pure beech high forest is frequently a fuel forest, and only a small portion of the yield is then treated as timber. Sometimes, owing to a favourable market, as, for instance, in the chair-making districts of Buckinghamshire and Oxfordshire, or in Belgium, this is not the case ; but frequently the timber yield of a pure beechwood is not more than 10 to 20 per cent. of its total yield.

Wherever aspen, birch, willows, limes, etc., are mixed with beech, there is a rise in the timber yield, but this can be considerable only when oak, ash, sycamore, or elms are mixed with the beech. Such mixtures are the most valuable forms of broadleaved high forests, as in them the light-demanders thrive best and attain their best shape. The timber yield of such forests may be 20 to 30 per cent. of their total yield, and even more. A mixture of conifers in beech forest is very valuable, as the former then attain their best dimensions and quality.

In the Rottenbuch forest range, which is the range richest in fine oak trees of the whole Spessart, the yield of oak-timber between 1860 and 1880 was 26 per cent. of the total yield.

The yield of oak-timber does not depend so much on the quantity of oak-trees in a mixed wood as on their age and

soundness, and throughout the renowned oak-forests of the Spessart usually only 40 per cent., or at most 50 per cent., of the felled oak-trees can be used as timber, the remainder usually yielding only inferior firewood. [In the French State forests of Bercé and Belleme the percentage of oak to beech and hornbeam is 50 and the yield in oak timber at least as high as in the Spessart.—Tr.]

Pure alder-woods yield chiefly timber, but are, unfortunately, decreasing in area, though greatly esteemed for the manufacture of cigar-boxes. [In Britain they yield gunpowder charcoal and clog-wood.—Tr.]

It is rare to obtain more timber than firewood from broad-leaved forests; the contrary prevails in coniferous woods, and wherever conifers are grown, mixed with broadleaved trees, they form splendid trees, and the yield of such forests in valuable timber is very high. Woods of spruce, silver-fir, and Scots pine [also larch in Britain.—Tr.] or mixed forms of these with beech as a subsidiary species are the chief kinds of coniferous forests in Europe. In the case of spruce and silver-fir woods, the timber yield may, under favourable circumstances, go up to 75 to 80 per cent., and exceptionally be even higher; in forests of common pine, up to 55 to 70 per cent., whilst in the north of Europe their yield in timber may equal that of spruce and silver-fir.

Coppice-with-standards, on good soil and well stocked, yields fine timber; it is the only system capable of yielding the hardest and most durable wood of oak and ash.

Coppice yields chiefly firewood, and also small wood required in agriculture, such as hop-poles, vine-props, hurdle-wood, laundry-props, orchard and garden tree-props, crate-wood, bean and pea-sticks, fascines and osiers. Also much pit-wood for mines.

ii. *Shape of Trees.*

As a rule, large dimensions in length and diameter, and straight and cylindrical stems, are required for the best timber. A large diameter is generally more important than great length, and it is trees of large diameter which are most saleable at present. As this implies long rotations, the yield

in timber in even-aged woods increases naturally with their rotation, up to a certain point.

In uneven-aged woods, where there is a stage of inferior trees below the more valuable ones, the latter may attain their largest dimensions in diameter, and cylindrical shape. Although, as stated, the yield of timber from a wood increases with its age, it must not be supposed that the poles which are the produce of thinnings are not utilisable as timber (for paper-pulp, pit-props, etc.). As a rule, the best timber should be as straight as possible : the demand for crooked and curved timber required for ships, boats, wheelwrights, saddlers, etc., is produced only by standards over coppice or by hedge-row trees ; but since timber is bent artificially, the demand for naturally curved trees has been reduced.

iii. *Quality of the Wood.*

The first enquiry should be to ascertain whether or not the wood is perfectly sound, absolute soundness being the first condition of the admissibility of wood as timber ; this should be investigated most carefully in the case of trees from old woods, whether broadleaved or coniferous, which are destined for long water-transport and may not be carefully treated in the timber depots. The grain of the timber should be considered next, whether it be coarse or fine-grained, knotty or free from knots. The mode of disposal of timber from pines, larch and oak, is affected by the quantity of heartwood the trees contain, also by the fact that its fibre is straight or twisted, splits easily or with difficulty, its stem more or less cracked, containing cup-shakes, etc. These defects have been described in Chapter I.

From what will be said in Chapter VI. it will be evident that the quality of a timber should govern its future mode of utilisation.

Local defects in a stem may render only a part of it useless for timber, and this is especially the case with oakwood and other valuable goods. In converting such wood, therefore, great care must be taken to utilise fully all the good pieces.

The present market-prices for sound, straight-fibred wood

are at least 30 per cent. higher than for wood of ordinary quality, with which the market is glutted. For certain industries the structure of the annual zones of wood and its grain are of the highest importance, as in wood for musical instruments and mast-wood, also in the grain of fancy woods for furniture. The degree of fissibility is also highly important, especially in extensive coniferous forests, where a very large amount of the annual yield of wood is split into various wares; also in the case of oakwood, suitable for staves. In some forests, as in Bavaria, the trees are examined as to their fissibility before being felled, by trimming off a patch of their sapwood. Not every kind of heart-shake will render a tree unsuitable for timber, and even a heart-shaken tree may be sawn into planks provided the shake is in a line right through the core of the tree; heart-shakes also are often confined to the base of the tree, and may be disposed of by sawing one or two short logs from it.

Cup-shake and twisted fibre may however render a tree unfit for timber.

(b) Demands of the Market.

The mode of conversion to be undertaken depends also on the demands of the market. For wherever there is no demand for any sort of converted timber, nor for any timber at all, it is evident that firewood only will be prepared. The demand is measured by the price, and wherever any assortment of timber fetches a higher price than firewood, conversion into timber should result. The rule should therefore be to produce as much good timber as can be utilised profitably, without including the smaller sized material resulting from thinnings with which the market is soon glutted. The demands however for timber now-a-days are subject to great variations, and there is a considerable demand for poles for paper-making and pit-timber.

Wherever there are forest-rights to firewood, the outturn in timber is limited by their demands, and frequently, if such rights cannot be compensated in money, wood of the best quality has to be sacrificed to meet these demands.

On the average in the different German countries, the

production of timber is really large only in Saxony, and was as follows in 1899 :—

| Country. | Percentage of whole yield. | |
|------------------------|----------------------------|-----------|
| | Timber. | Firewood. |
| Alsace-Lorraine | 42 | 58 |
| Baden | 49 | 51 |
| Bavaria | 51 | 49 |
| Württemberg | 56 | 44 |
| Prussia | 56 | 44 |
| Saxony | 79 | 24 |

All these figures are not prepared on the same basis, as in Saxony. 60 per cent. of the wood is used for paper-pulp and mine-props, while the comparative richness or poverty of a country in coal affects greatly the demand for firewood. In the Bavarian Alps nearly all top-and-lop is left in the forests, so that the percentage of wood brought out is 90 per cent. in timber. Such figures therefore are of relative value only.

2. *Timber-Assortments.*

It is evident that generally the woodcutter cannot undertake to prepare timber for the market in the ultimate form it assumes when taken over by the different industries. This would require much too extensive a knowledge of the latter. As a rule, therefore, it suffices to divide the trees into transportable pieces which by their dimensions and qualities are suitable as the raw material of an industry, or of a whole group of industries. The further detailed conversion may be left to the special industries, or to the wood-merchant. In small private forests, however, matters may go further in this respect.

[The best example in Europe of detailed conversion as well as of labour-saving means of transport may be seen in the Sihlwald, belonging to the town of Zurich, where the wood is converted on the spot into all kinds of commodities, down to wood-wool for packing.—Tr.]

The various pieces into which a tree may be converted by

the woodcutter are termed rough assortments of timber, and are distinguished as follows :—

| Timber. | | | | | | | | Firewood. |
|----------------|--|-----|-----|-----|-----|-----|-----|-------------------------|
| Logs | ... | ... | ... | ... | ... | ... | ... | Split billets. |
| Butts | ... | ... | ... | ... | ... | ... | ... | Round billets. |
| Poles | ... | ... | ... | ... | ... | ... | ... | Root and stump billets. |
| Stacked timber | ... | ... | ... | ... | ... | ... | ... | Faggot-wood. |
| Brushwood | Material (beansticks, etc.) from the crowns of trees, from young thinnings and coppice fellings, other than faggot-wood. | | | | | | | |

(a) Timber.

Timber is usually in logs or poles, sawn or cloven pieces. It is also popularly distinguished according to its destination for building purposes, implements, manufactures or agriculture.

Building-Timber is used in superstructures, bridges, embankments, mines, roads, railways, or in ship and boat-building.

Timber for Implements is used for water-mills, windmills, stamping-mills, oil-mills, etc.; also in many countries for cartwrights' work, etc.

Manufacturers' Timber is used in all ordinary wood-working industries, such as cabinet-making, carriage- or cart-building, turnery, wood-carving, coopers' work, etc.

Agricultural Timber is used for gates and fences, hop-poles, hurdles, stakes, pea and bean sticks, etc. (*vide* Chapter VI.).

From a careful consideration of the distinction between the different kinds of timber available, a forest-manager will readily perceive how his trees should be converted in order to meet these various requirements.

Wood from stems is usually classed as logs or butts. The distinction between stems and poles and between logs and butts varies in different forests, but the following classes usually occur in the timber-trade.

i. Logs.

Logs are the boles of full-grown trees, or the greater part of them, after they have been topped and freed from branches. Logs should measure at least 23 feet (7 meters) in length ;

their mid-diameter should be at least 6 inches (15 centimeters) without bark, including the bark, 7 inches (18 centimeters).

In most cases the longer and straighter the logs and the greater their diameter at the smaller end, the greater is their value. Logs are used chiefly in the different building-industries, but also to a small extent for implements, sails of windmills, stamping-hammers, etc.; as cloven-wood, for which only straight-fibred timber is admissible, they are rarely required in full length; as sawn material they are used chiefly in building ships, barges and boats, also for bridges and in mines.

ii. *Butts.*

Butts are round pieces of stems or of exceptionally large boughs, usually cut from the shorter and thicker part of either. A butt should be less than 23 feet (7 meters) in length, but at least 7 inches (18 centimeters) in mid-diameter measured without the bark. Whilst therefore in length a butt is surpassed by logs, its chief value lies in its larger diameter.

Butts are chiefly coniferous, as broadleaved timber is now exported mostly in logs. They are used for piles, mining purposes, railway-sleepers; shorter pieces (partly curved) in shipbuilding; also in the construction of bridges and roads. In machinery they are in demand only slightly for rests, or sockets, anvil-stocks, pounding-troughs, etc. They are largely used as cloven-wood by the stave-maker, cooper, wheelwright, turner, shingle-maker, etc., also for wood used for musical instruments, gunstocks, etc. Butts are, however, used chiefly for sawn timber, and the bases of coniferous stems to form butts for sawmills in lengths of 10, 12, 14, 16, 18, 20 and 22 feet, those from 12 to 16 feet long ($3\frac{1}{2}$ to 5 meters) being preferred.

Wood also of oak, beech, poplar, alder for cigar-boxes, and other kinds, is cut into butts of similar dimensions for sawing.

iii. *Poles.*

Poles are young stems, generally the produce of thinnings or coppice-fellings, and usually measure less than 7 inches (18 centimeters) and down to $2\frac{1}{2}$ inches (6 centimeters) in mid-diameter, being always measured unbarked. They are usually

sold unbarked at their full length for pit-props, shafts, ladders, hop-poles, tree-props, walking-sticks, umbrella-handles, bean-sticks, etc. They may also be split into crate- or hurdle-wood, but are sawn into scantling very rarely.

iv. *Stacked Timber.*

This is in the form of round or split pieces, which are piled like cordwood and sub-divided into two classes—

Pieces over 6 inches (15 centimeters) in mid-diameter.

Pieces $2\frac{1}{2}$ (6 centimeters) to 6 inches in mid-diameter.

Stacked timber is used by the clog or sabôt maker, cooper, brush-maker, sieve-maker, wheelwright, turner, stave-maker, and in many places worked into vine-props. Round pieces are used now chiefly for making paper-pulp.

v. *Brushwood.*

Wood less than 8 inches (7 centimeters) in diameter at the thicker end is termed brushwood, and is generally piled between stakes. It is partly branchwood, but chiefly the produce of coppice, and is used for fascines, pea-sticks, brooms, fencing material, etc. In the case of osiers it is used for basket-work.

(b) **Firewood.**

After all the wood which can be used as timber has been prepared, what is left is firewood.

Firewood is stacked for measurement, and termed cordwood. In Germany, Austria-Hungary and Switzerland, the usual length of pieces of cordwood is 1 meter, or 89 inches, but this measure is not compulsory, provided the volume is computed in stacked cubic meters or feet. [In Britain the length of billets is usually 8 feet.—Tr.]

Firewood is distinguished as follows according to the shape and size of the pieces:—

i. *Split Billets.*

Split firewood comes from stems and branches measuring across the smaller ends at least $5\frac{1}{2}$ inches (14 centimeters), in Switzerland, $4\frac{1}{2}$ inches (12 centimeters).

A billet of split firewood should measure from $5\frac{1}{2}$ —8 inches (14 to 20 centimeters) along the chord of its smaller end, and exceptionally up to 11 inches (28 centimeters); it should always be split from the core of the tree.

ii. *Round Billets.*

Round firewood billets are unsplit round pieces of wood $2\frac{1}{2}$ — $5\frac{1}{2}$ inches (7—14 centimeters) in diameter at the thin end. In many districts, wood of this class is split in half. Round pieces of larger dimensions are used sometimes in charcoal-making.

It is advisable always to split the round pieces of firewood in order to ensure drying, reduce carriage and increase the heating power of the wood. Experiments have shown that round firewood when split loses 27—28 per cent. more weight in the five winter months than unsplit wood, and Schuberg has proved experimentally that its loss in weight in four weeks' time is double that of unsplit firewood.

iii. *Stump- and Root-wood.*

Pieces of stumps and roots of all sizes, provided they are not longer than the other pieces of cordwood and may thus be conveniently stacked, form this class of firewood.

iv. *Faggot-wood.*

Faggot-wood includes all refuse crown, branch, and coppice-wood under $2\frac{1}{2}$ inches (6 centimeters) in diameter at the larger end.

This is either piled in heaps about equal in size, or tied into bundles termed faggots, or bavins, which are of about the same length and circumference as split cordwood billets. The remaining refuse of the felling is collected in heaps, and may be given away to the workmen, or auctioned.

3. *The Work of Conversion.*

The work of conversion comprises the woodcutter's work of preparing the different assortments just described from the

felled trees, and demands the greatest care and supervision on the part of the forest manager.

(a) Conversion of Timber.

i. *Removal of Branches.*

First the felled tree is freed from branches from its base upwards, the axe, or lopping-axe with a thick back, being generally used for the purpose.

The branches must be severed smoothly close to the stem, and all projections on the stem and stumps of branches removed. If the branches are large enough to make cord-wood they may be sawn into suitable lengths whilst still attached to the stem. In other cases, and where it is preferable to use the axe, the branches may be cut from the stem and placed aside while the woodcutter is occupied with the stem. Whilst one man of a party removes the branches the others shorten the stem. In most cases the branches are fit for firewood only, but wherever some of the boughs in the large crowns of certain trees can be used as timber they should be set aside carefully, as thus pieces of valuable curved and kneed wood may be secured.

In the case of oak trees the portion of the stem above the insertion of a large bough is so reduced in diameter that the stem should be severed at this point. The top is so much the more valuable if it forms a knee with an upper bough.

Knee-pieces also may be obtained from a portion of the base of a tree and of a strong root, if the tree has been uprooted.

ii. *Measuring the Stem.*

Once the stem has been freed from branches it is measured with a yard or meter measure, and the different yards or meters marked on it by slight cuts in the bark. If the stem is fit for fuel only, it is then sawn through at these points (or into other short lengths); if intended for timber, it is cut into suitable lengths according to circumstances.

iii. *Determining the Assortment.*

Once the tree has been freed from branches and measured, it must be decided from a consideration of its species, dimensions, form and quality, and the demands of the market, into what assortments it will be converted. This decision is of the greatest importance; it usually should be made only by one of the forest staff. The usual rule is to allow the stems fit for timber to retain their full length as much as possible. There are many exceptions, however, to this rule, which is more applicable to coniferous than to broadleaved wood.

(a) **Quality.**—Only perfectly sound wood should be converted into timber. This rule is specially applicable in the case of oakwood, which is often full of defects. Large old beech, spruce and silver-fir trees are also often heartshaken, cracked, infected with red-rot, or brittle at the base of the stem. Whenever pieces of timber of doubtful soundness, or from which the defective parts have not been carefully removed, are offered for sale, future sales of timber are greatly prejudiced. When, therefore, there are any doubts as to the soundness of the wood, it is better to cut it into shorter pieces than to send suspicious looking goods to the market. The timber purchaser, now-a-days, has had too much experience of such pieces.

(b) **Shape of Stem.**—Wherever long pieces are in demand, it is unusual to include in them the small end of the stem. The next point is, therefore, to decide where the top should be cut: as a rule, this should be wherever there is a marked falling-off in size, or a change of shape, in the stem; wherever, in fact, the top of the stem may be utilised differently from its lower portion. By leaving a piece of wood at the end of a log, which does not accord well with it, the value of the latter is not increased, for the purchaser always excludes this piece from his estimate. If, however, the forest owner cuts off such a piece, it will be utilisable at any rate as firewood, and in the case of oak may be used as a railway-sleeper or gate-post, the value of which would not be considered by a purchaser of the bole.

Straight, long pieces which are chiefly coniferous, need not

after removal of their end-pieces, be further shortened, and this is also the case with sound oakwood, even if not quite straight. In such cases, the longer the log the more valuable it will be. But as regards coniferous wood further consideration is necessary. Logs in the Schwartzwald and elsewhere are sold by the length and the diameter of their smaller ends; this should be the universal rule with coniferous timber. In such cases, the best place for removing the end of a log is where the small-end diameter approaches as nearly as possible to the minimum admissible. This is rarely less than 6 inches for logs, and it may be laid down as a general rule, that the small-end diameter of a log should be one-third of that at its base.

Formerly coniferous logs were sold usually by their cubic contents calculated from their length and mid-girth, but recently this measure is being abandoned for that of their length and small-end diameter. In such cases the measuring of the mid-diameter serves only to calculate the cubic contents.

(c) **Demands of the Market.**—There are districts where long logs are not in demand, but butts for sawmills are preferred, and the finest spruce-logs are cut into suitable lengths for the neighbouring sawmills; where fine, straight oak stems must be cut into short lengths for staves, and so on. In other districts long logs are required for floating. In such cases, the custom of the trade must be followed in converting the timber. It should also be considered whether, or not, the customs of the market are stable, the former being frequently the case in districts richly supplied with sawmills, and more so with coniferous than with broadleaved wood. In other cases, and especially with oak-timber, the demands of the market are very variable, depending on a good vintage, on large imports of foreign timber, etc. It is then prudent to cut the logs as long as possible, provided they are sound.

In other districts, where timber is used chiefly for local purposes and both short and long logs are wanted, it is better to cut one or two butts for sawmills from the base of the stems and retain the remainder as long as possible for building purposes. A prevalent demand for long logs will occasionally

modify this rule and decide on the number of sawmill butts which will be sawn from the stem. It is not, as a rule, financially advisable to prepare butts for sawmills of less mid-diameter than 12 to 13½ inches (30 to 35 centimeters); small butts may, however, be split or sawn into laths.

(d) **Facilities for Transport.**—In converting large standards over a dense growth of saplings or poles, it is often considered best, out of respect to the young wood, to cut them into short lengths. Exceptionally this may be justifiable, but usually should be avoided, for the standard was retained expressly to yield large timber.

All shortening of stems should be done with the saw, and only long logs which are to be dragged along the ground, slid down-hill with ropes, or floated in rafts, should have their larger ends rounded with the axe.

There are many localities, in more or less accessible mountain districts, where the method of conversion depends on the possibility of transport, and where the preparation of long logs cannot be contemplated, because they cannot be removed.

iv. Exposure of Defects.

All wood, and especially pieces of valuable broadleaved timber, should be exposed by cutting through all swellings, or overgrown knots, so as to show its inner quality and increase the confidence of the purchaser.

In the Spessart, and for the Baltic trade, oak-logs are split down the centre into half-balks, so as to expose completely the interior of the wood. This wood is used by the cabinet-maker.

v. Preparation of the most Valuable Assortments.

Whenever stems may be converted in several ways, that way should be adopted which is expected to yield the best price.

vi. Conversion of Poles.

Poles, suitable for pit-props, hop-poles, cart-poles, telegraph-posts, ladders, shafts, hurdles, bean-sticks, etc., which come partly from the principal fellings, but chiefly from thinnings,

present the least difficulty in conversion. The species, and the greatest possible degree of straightness, are the chief points to attend to.

In some cases it is necessary to leave the poles quite unshortened, as for hop-poles, where the branches are not lopped off close to the stem, but snags of branches are left to assist the climbing of the hops. Sometimes the tops are left, as a



Peeling-irons.

Fig. 149.—Common. Fig. 150.—Black Forest. Fig. 151.—Upper Bavaria.

proof that the poles were not dead when felled. Clothes-props also, and props for trees, are left forked at the top. The top is removed from cart-poles.

The dimensions of the different assortments vary locally.

Thus, hop-poles may be between 16 and 30 feet (5 and 10 meters) in length. Telegraph-posts should be 7 to 10 inches (18 to 25 centimeters) in diameter, at 1 yard from the butt-end; hop-poles $2\frac{1}{2}$ to 5 inches (6 to 12 centimeters). Hop-poles generally are felled deep into the ground with the axe, whilst

ladder-wood and wheelwright's wood should be sawn straight at the butt.

vii. *Removal of Bark.*

All stems felled during summer in coniferous forests are usually barked to prevent insect-attacks, facilitate transport and preserve the white colour of the wood. The wood may be barked completely, whenever this can be done, as in spring and early summer. During autumn and winter the bark can be removed only partially.

Although complete barking gives the wood a better appearance, yet the rapid drying which ensues frequently causes numerous cracks into which spores of fungi are conveyed by the rain, and then the timber is liable to decay unless rapidly transported to its destination.

In this respect partial barking is superior. The tools used for barking are shown in Figs. 149, 150, and 151, and compared with the axe they save 50 per cent. of labour. Usually large stems with rough bark, especially during winter, are barked with the axe or adze.

It has recently become usual to bark round stacked pieces, especially pulp-wood; also the larger poles and especially hop-poles, but then only partial barking is necessary.

(b) **Preparation of Firewood.**

Firewood, especially split and round firewood, is prepared from the remains of the stem and branches after conversion of the timber; or whole firewood trees, as in beech forests, are freed from branches, marked-off into lengths, and then sawn into short butts.

In cutting-up butts for firewood, chiefly the curved saw is used, and the work is assisted by wedges, which are inserted as soon as the saw-cut is deep enough. Woodcutters must be careful not to cut obliquely, as they may easily do by mistake on sloping ground. The cut must be at right angles to the axis of the tree, if the cords of firewood are to have a good uniform appearance. As a rule, the larger branches are also cut into lengths with the saw, which should be used in converting wood whenever it is possible. Only on very steep, rocky

ground, where the workman cannot find room to use the saw, or when stems are lying one over the other, etc., may the axe be used for this purpose. The wood should then be cut so as to have one cut vertical and the other oblique, as in Fig. 152. By the use of the axe from 6 to 8 per cent. of the wood is wasted, being 7 per cent. when the pieces are 1 meter long.

The round pieces over $5\frac{1}{2}$ inches in diameter at the smaller end are then split by means of the wedge and cleaving-axe into split cordwood, and whenever the trade prefers that round cordwood should be split, this should also be done.

The wedge is generally placed on the top of the round piece,



Fig. 152. Method of cutting firewood.

and driven in by a blow of the axe-head. Whenever the wood is difficult to split this forms the chief part of the woodcutter's work in the preparation of firewood. He requires several wedges of different sizes,

and even uses the cleaving-axe as a wedge, driving it in with the beetle. It is only in the case of easily split wood that the wedge may be placed on the side of the round pieces. Pieces $5\frac{1}{2}$ to 8 inches (14 to 20 centimeters) across, are usually merely split in half, whilst pieces 8 to 12 inches (20 to 30 centimeters) across are split into six or eight pieces. Except in the case of very large trees, the pieces always are split to the core. It would, however, be better, both to facilitate transport and improve the quality of the wood, that no pieces exceed $5\frac{1}{2}$ to 8 inches (14 to 20 centimeters) measured along the chord.

(c) Refuse.

Pieces too knotty or of too twisted fibre to be split remain entire and go with the refuse, after the conversion is over.

(d) Cloven-timber.

In the conversion of firewood, billets which may be otherwise utilised should be put aside carefully. This is specially necessary with oakwood; and from the broken pieces of trees which cannot be converted into logs, or butts, many billets may be utilised as cloven-timber, and they should be carefully

freed from all defective portions and from sapwood. They need have no fixed dimensions, but should be as large as possible and of whatever length is desirable.

(e) **Conversion of Stumps and Root-wood.**

The most laborious of all works in conversion of wood is that of the stumps and roots. If the tree has been uprooted, the roots are separated from the stem by means of the saw, and they are then freed from the soil which may be attached to them and reduced in size by means of the wedge and axe, or by blasting them with powder or dynamite.

In separating the roots from uprooted trees, it sometimes happens, in easily cloven wood, that when the saw has gone about half through the base of the stem, the stump splits the stem owing to its weight and falls back into its original hole. To prevent this disaster, a chain may be wound round the stem below the saw-cut and tightened by driving in wedges, and the stump supported by pieces of wood.

i. *Conversion of Stumps by means of Ordinary Tools.*

Small stumps up to 3 inches across are not split. Those from 3—6 inches are split lengthwise by means of the axe and wedges, the wedges being usually placed on the sawn section, and if it is also necessary to begin splitting from below as well, always from the projection of a side-root, where the stump is most easily cloven. If possible, the wood should be split to the core, but this cannot be done in the case of thick stumps of coarse fibre, from which pieces are split-off gradually from the circumference. This method of splitting is effected more easily while the stump is still in the ground, than after it has been extracted. Wooden wedges, holding better than iron ones, are more serviceable in splitting stumps. In order to tear apart the pieces more thoroughly, iron crow-bars are used, and the ordinary screw-jack is very serviceable. It has been stated already that machines may be used for extracting stumps.

ii. *Blasting Stumps by Gunpowder.*

The stump which is to be blasted by a charge of gunpowder is bored best from its flat surface by means of a large auger (Fig. 153), so that the bore-hole may go down to the junction



Fig. 153.—Augers for boring wood.

of the roots. In case the tree is rotten at the heart, the boring must be made from one of the sides. The charge should consist of $1\frac{1}{2}$, 3 or $4\frac{1}{2}$ ozs. of blasting-powder, and a fuse should be introduced, or some other arrangement made for firing the blast. Frivolin and Ryssel used ordinary percussion caps for the purpose. Fig. 154 shows a simple detonator, the ring (a) being for the insertion of a handle for screwing it into the bore-hole, whilst (b) is a simple trigger for striking the cap. Urich improved matters further

by using an apparatus with a needle for firing the cap, which was placed on the top of the powder, as shown in Figs. 155, 156, the former giving its external form, and the latter a section through its axis. The apparatus has a bore sufficient

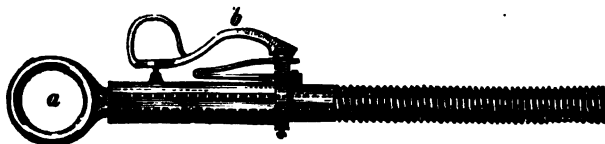

Fig. 154.—Frivolin's detonator.

for the working of the needle (*m o*). It is closed by a screw-lid (*b*) in which the cap (*n*) is placed. In order to prepare the apparatus for firing, the needle is raised by means of the ring (*m*), and a steel pin is placed in the aperture (*d*). The lid (*b*) is then removed, and screwed

on again after a cap has been inserted. The charge is fired on the removal of the pin by means of a long cord, the needle being driven down on to the cap by a strong spiral spring placed above the ledge (*m*). The advantage of this apparatus consists in the fact that it is not necessary to fill it with powder, but a cap only is required, and the firing of the charge follows immediately on the release of the needle, which can be done from a distance with perfect safety, whilst no tamping is required for the blast, the strong apparatus screwed into the bore-hole serving instead; the

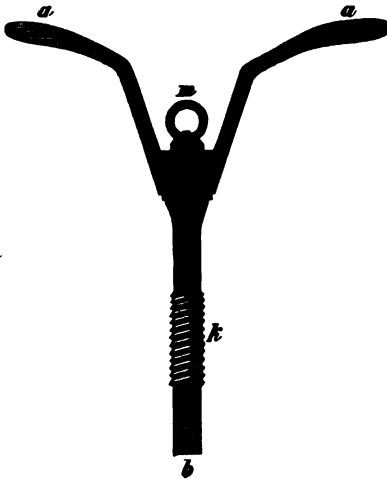

Fig. 155.—Urich's detonator.



Fig. 156.—Section of same.

results are excellent, the largest stumps being split into two or more pieces.

Whenever only a fuse is used, after less than half the powder has been poured into the bore-hole, the fuse, made of tarred yarn surrounding a thin column of powder is inserted, and then the rest of the powder. Then the remainder of the bore-hole is filled with earth or clay as a tamping, and firmly rammed-down.

The portion of the fuse 4—6 inches long, which protrudes beyond the hole, is lighted with a match and in 1—2 minutes the explosion follows.

iii. *Blasting Stumps by Dynamite.*

Dynamite is a more powerful explosive than gunpowder, and is obtainable in cartridges resembling brown stearine candles encased in thick paper. It becomes hard at temperatures of 45° to 50° Fah. and cannot be heated above 108° Fah. without danger. It will not explode unless it be at least as soft as wax, and must therefore be warmed slightly during winter.

According to the size of the stump 1·7—2 grams (1—1·12 drams) of dynamite are required for every centimeter in the diameter of the stump, so that cartridges of 70 to 100 grams suffice for stumps of 0·50 to 0·70 meters in diameter [*i.e.*, 2½ to 3½ ounces for diameters of 1 foot 8 inches to 2 feet 3 inches.—Tr.], provided the wood is not too difficult to split.

The dynamite-cartridge (*p*) in Fig. 157, is then placed in the bore-hole, which should be of suitable bore to admit it, and rammed home with a wooden ram-rod. A smaller cartridge (*z*) is used in connection with a fuse for firing the charge, the end of the fuse being placed on the soft mass of dynamite of this cartridge, and tied firmly above it in the paper covering of the latter. This firing-

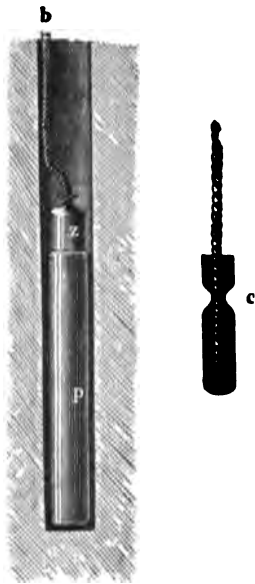

Fig. 157.—Blasting with dynamite. *c* Fuse.

cartridge and fuse is then let down on to the blasting-cartridge in the bore-hole. The vacant space in the bore-hole is then tamped with earth and the fuse lighted.

Whilst blasting with powder frequently only cracks the stump, by the use of dynamite it may be torn into several pieces.

As regards the cost and saving of labour by blasting the stump, various estimates representing from 30 to 50 per cent. labour saved have been made; for oak-stumps the cost is estimated at 6*d.* per stacked cubic meter cheaper than manual labour, and for Scots pine at 3*d.* more.

Dynamite can be used with advantage only on completely uprooted stumps, for it has scarcely any effect on those still in the ground. Owing to its highly explosive nature, dynamite will not be much used for blasting stumps in forests at any rate during winter; also on account of its high price and because it is a strong poison.

The use of blasting powder can, however, be strongly recommended for this purpose wherever the price of labour is high, and stumps have to be split.

(f) Preparation of Faggots.

Wherever twigs and branches are in demand for fuel, they are cut into lengths with the bill-hook and bound into faggots, or bavins, by means of one or two withes or binders.

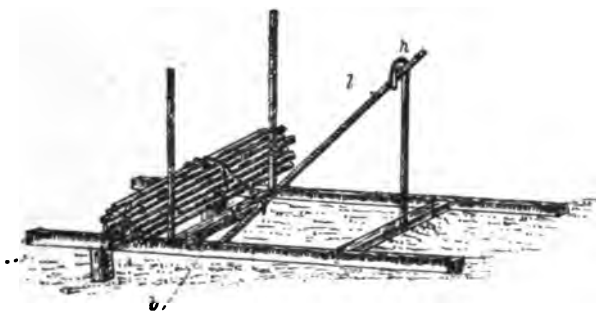

Fig. 158.—Faggot-binder's press.

[Fernandez* gives a simple frame for faggot-binding as shown in Fig. 158. The lever (*l*), the lower end of which rests against the bar (*b*), is drawn towards the operator and hitched into the hook (*h*), thus tightening the chain over the bundle of sticks. The withes can now be tied and the pressure on the faggot released by unhitching the lever; the length of the chain, which can be varied, regulates the size of the faggot.—Tr.]

In other cases, small branchwood may be carried to the nearest roadside and stacked in heaps between stakes.

Faggots should be made in whatever dimensions the public

* "Utilization of Forests," p. 108.

prefer. In country districts usually long thick faggots are in demand: near towns they are preferred when not exceeding 80 pounds in weight; they may be $1\frac{1}{2}$ feet long and $2\frac{1}{4}$ feet in girth, five smaller ones being bound-together to make a faggot.

The best withes are slender oak coppice-shoots, but hazel, sallow and birch, etc., will serve the purpose. These withes are freed from all side-shoots, and when freshly cut, or steeped in water, are placed on a fire to make them pliable; they are then twisted like ropes into a loop at the thin end, through which the thick end is drawn when they are fastened round the faggot.

4. Removal of Wood previous to Conversion.

It has been presupposed hitherto that the conversion of the felled wood takes place on the felling-area near the stumps of the felled trees, and this is generally the case.

There are, however, circumstances in which it is necessary to remove the wood from the felling-area, or at any rate away from the stumps of the felled trees, before it is converted;—as in a young crop, during the final stage of natural regeneration; under a shelter wood, in selection-fellings, cleanings and thinnings. Splitting firewood and conversion of the easily transportable poles and saplings may then be effected on neighbouring blanks, roadsides, etc.

Wherever the firewood before being stacked has to undergo a further transport by water, sledge-roads or slides, it is advisable to convert it into short butts, and to split these up only after they have been transported to a depot.

5. Occasional Non-conversion of Firewood.

Owing to the present greatly reduced price of firewood, foresters often are obliged to give up converting it in the regular way just described. Wood yielding only round billets and faggots, especially from extensive thinnings, may then be simply carried unshortened, including the crowns, to the nearest roadside, and stacked between stakes.

There are districts where there is absolutely no demand for small poles, saplings, and branch-wood, as in many Alpine

forests, or in districts containing many private and communal forests.

6. *General Rules regarding Conversion.*

Forest-managers should bear in mind the following rules regarding conversion of timber and firewood :—

(a) The most urgent local demands of right-holders and contractors must be satisfied first, and the conversion of the remaining material effected from a strictly financial point of view, that is, with a thorough knowledge of the actual demands of the market.

(b) After carefully considering the demand, the wood should be converted so as to yield the highest possible net-value on deducting the cost of conversion. Hence, the mode of conversion is a purely local affair, and will vary greatly according to circumstances in different forest ranges.

(c) The conversion into any assortment should be regulated in quantity, so as not to glut the market, and to allow of the demands for other assortments being fully met. Forest-managers should, therefore, be conversant with the state of the supply of different classes of material from other forests which compete with their own.

(d) The rarer and more valuable any assortments, the greater care must be bestowed on their conversion. This is especially the case with oak and large coniferous timber.

(e) Conversion of timber often is effected better when different classes of workmen are employed for the different works. Thus, in broadleaved forests the work commences with the felling and conversion of the large timber trees; after all the best timber is ready, what is left is converted into firewood and other inferior assortments. In coniferous forests it is often customary and advisable first to prepare the various cloven wares, such as shingles, staves, etc., then the butts for sawmills and the logs, and finally the firewood.

(f) The forest-manager should ascertain always the wishes of timber-merchants, manufacturers and craftsmen of the neighbourhood, and they may be encouraged to visit the felling-area for this purpose, but he should be on his guard lest by following the advice of any of them competition for the produce may be reduced.

(g) Although it is justifiable, when the prices of wood are low and wages high, to attempt only a very rough conversion of firewood, or abandon converting it altogether, yet this should never be done with valuable material. Any carelessness in its preparation will do more injury to the forest revenue than paying high wages for good work.

(h) It is usually advantageous in forests where petty delinquencies are frequent, for the manager to compete with the thieves by selling better and cheaper material than they do, such as hop-poles, bean- and pea-sticks, Christmas-trees, etc.

SECTION VI.—SORTING AND STACKING CONVERTED MATERIAL.

1. *General Account.*

The rough conversion of the felled trees must produce many pieces of the same class, but of different qualities, shapes and dimensions, especially among the timber where scarcely two pieces are identically alike. As every producer keeps his wares of different kinds and qualities apart, so each kind of converted forest material should be separately arranged. In this way only can it be possible to estimate the probable value of the results of the felling, and to expose the lots for the inspection of the different classes of purchasers. The real object of separating assortments of woods used by various industries and consumers, is to obtain the highest possible price for each assortment. The arrangement of the assortments into classes should, therefore, be made on the following principles:—

i. All pieces which are of different value, and fetch different prices, must be put in separate classes.

ii. The classes must correspond always to the demands of the locality.

iii. The separation into classes should depend on differences of species, size, shape, quality, and demands of the market, and these will be discussed in detail further on.

iv. This separation must not be too minute, or go too much into detail, so that there can be any doubt about the proper classification of any piece, or too much difficulty in calculating and registering the results of the felling. There is a considerable difference in this respect between valuable pieces of timber

and common sorts of firewood. In the former case, the manager can hardly go too far in subdividing the classes, and a difference of price exceeding $\frac{1}{2}d.$ per cubic foot should cause a different class of timber to be established.

A difference of value is, therefore, the chief reason for a difference in class of material.

2. *Detailed Account.*

(a) **Species.**

The species of tree has a great influence on the use to which the wood can be put. Timbers of different species should, therefore, be separated into classes, or at least species of equal value should be classed together. The same procedure should be adopted in the case of firewood, or where there are few of them all inferior kinds should be separated from those more valuable.

Of great importance in sorting felled material is the comparative abundance or rarity of any species. Thus, where valuable oakwood is abundant, the chief point to attend to will be to classify the oak timber; in coniferous forests, to classify the spruce or pine timber, and in beechwoods the beech-timber and the better classes of firewood.

(b) **Dimensions.**

Logs, butts, and poles will be classified according to their dimensions. As the value of a log or butt is not always directly proportional to its cubic contents, but to its length, or thickness, and in the case of coniferous wood to the thickness of its smaller end, the pieces will be classified accordingly.

Such classes are formed according to differences of about 6 feet in length, and 2—4 inches in thickness. In the case of valuable timber, the classification according to thickness may go down to one centimeter. [Thus, in France, oak-timber increases in value at about one franc per cubic meter, for every additional centimeter in diameter over fifty centimeters.—Tr.] The less valuable the pieces, the rougher the classification.

Large billets always increase the solid contents of a pile of stacked firewood, so that firewood also should be classified according to dimensions.

(c) **Shape.**

Curved timber should be classed according to the degree of curvature for a certain length, or in kneed-timber for the angle at which the branch leaves the main piece.

In classifying other timbers, the chief points to which attention should be paid are:—whether they are straight, bent in one plane, quite crooked, or contain burrs; also, whether they are clean-grained, or merely have been trimmed free from many branches and are knotty.

In the case of firewood, also, straight billets of split or round stem-wood should be piled separately from crooked and knotty branch-wood.

(d) **Quality.**

Independently of its soundness, which is always presupposed in the case of timber, there is a great difference in quality depending on its grain. Thus, we have coarse-grained and fine-grained timber, timber with broad or narrow annual zones, with straight, twisted, or wavy fibre. Some stems are naturally smooth on the surface, others lumpy owing to occluded knots. All these circumstances affect the value of the pieces and should be considered in sorting them.

In the case of firewood any unsound and broken pieces should be piled apart from the better wood, and as the age of the tree often influences the heating-power of the wood, young or very old wood may be separated from middle-aged wood.

It cannot be repeated too often that only sound wood should be classified as timber. Wood, in its present struggle against iron and other substitutes for it, can win the day only when it is sound and durable. This is especially the case where the wood has to be transported long distances, and is subject to indifferent treatment before it reaches the consumer.

(e) Local Demand.

In classifying the produce attention always must be paid to the local demand. Thus, in certain localities, custom may render it necessary to classify wood in a way that is quite uncalled for in other localities. Whilst, however, sufficiently conforming to custom in this respect, the manager always should attend to the chance of changes being introduced gradually in conformity with the demands of more distant markets than his own immediate surroundings.

3. List of Wood-assortments.

The following list gives all the common sub-divisions of the different classes of produce from the fellings.

A. LARGE TIMBER.

(a) Logs.

i. Oakwood (Spessart), 10—30 feet long and of normal quality.

Class I., logs over 26 inches in mid-diameter.

| | | | | |
|---|----------|-------|---|---|
| „ | II., „ | 24—25 | „ | „ |
| „ | III., „ | 22—23 | „ | „ |
| „ | IV., „ | 19—21 | „ | „ |
| „ | V., „ | 16—18 | „ | „ |
| „ | VI., „ | 13—15 | „ | „ |
| „ | VII., „ | 10—12 | „ | „ |
| „ | VIII., „ | 5—9 | „ | „ |

Defective timber is put back one or two classes and very defective timber two or three classes lower than their dimensions would otherwise warrant. Logs of good quality longer than 30 feet are put forward one class, or even two classes, if the timber is very superior.

ii. Coniferous Timber.

After rejecting wood from diseased trees and setting apart the finest ringed and straightest grained wood, the outer shape

and the dimensions of the timber form the chief guide for classifying coniferous wood. As regards dimensions, the logs may be classified according to the mid-diameter, or to the small-end diameter. In no other case has the latter so important a bearing on the value of the timber, as in coniferous logs, and accordingly in many districts of South Germany the classification is so arranged. The mere volume of the logs is a bad index of their comparative value.

In accordance with the Heilbron classification, which is almost everywhere preferred by the German timber-trade, coniferous logs are classed as follows :

| Class. | Length. | | Diameter at small end. | |
|--------|--------------------|-----|------------------------|------|
| | M. | Ft. | CM. | Ins. |
| I. | 18 = 58, and over, | | 30 | 12 |
| II. | 16—18 = 52—58 | | 22 | 9 |
| III. | 14—16 = 45—52 | | 17 | 7 |
| IV. | 10—14 = 32—45 | | 14 | 5 |
| V. | up to 10 | 32 | 12 | 4½ |

All the timber must be sound and free from branches ; rough but sound timber goes down a class. The diameters are measured under bark.

Classes lower than V. comprise ordinary or inferior building-timber, rafters, fencing rails, pulp-wood and pit-props. In Bavaria, a sixth class, with at least 6 cm. (2½ inches) diameter at small end, is added.

If the wood is classified by mid-diameter the classes are as follows :

| Class. | Mid-diameter. | |
|------------|------------------|------------------|
| I. and II. | 35 cm. and more, | 14 inches. |
| III. | 25—35 ,, | 10—14 ,, |
| IV. | 20—25 ,, | 8—10 ,, |
| V. | under 20 ,, | 8 ,, |

iii. Remaining Species.

Broadleaved trees, other than oak, do not yield much marketable timber ; the exceptions to this rule are, elm, ash, alder and aspen. [Willow, sweet-chestnut and sycamore are valuable in Britain.—Tr.] In many cases each of these

woods may be classified separately, and the others classed together. Wherever any of these timbers are of special value, they should be classed separately.

(b) *Butts.*i. **Oak (Spessart).**

| Class. | Length. | | Mid-diameter. | |
|------------------|---------|---------------|---------------|-------|
| | M. | Ft. | CM. | Ins. |
| I. not less than | 8—10, | not less than | 75 | 30 |
| II. „ | 3—10 | „ | 66—74 | 26—29 |
| III. „ | 3—10 | „ | 61—65 | 24—25 |
| IV. „ | 3—10 | „ | 55—60 | 22—23 |
| V. „ | 3—10 | „ | 48—54 | 19—21 |

Inferior wood goes down a class, and very superior wood goes up a class.

The above timber is for sawing, staves, cabinet-making window-wood, etc. Curved wood, knees, and railway-sleeper wood come in here, also inferior wood for split wood, wheelwrights, and wood for sawing.

ii. **Coniferous Wood.**

Class I., butts of best quality for musical instruments, shingles, and other split ware.

Class II., butts of 14 inches mid-diameter and over; straight-grained.

Class III., butts of 10—14 inches mid-diameter.

Class IV., butts of less than 10 inches mid-diameter.

Class V., butts of inferior quality and of various sizes.

The wood in these classes is chiefly intended for sawmills to be converted into planks, boards and scantling. The wood must be classed according to species, and occasionally more classes than those given above will be required.

As regards length, it is generally constant for the same locality, according to the custom of the sawmills or floating trade. The timber-trade prefers lengths of 10, 11, 12, 14, and 18 feet. The smallest class is usually for water-pipes.

iii. Remaining Species.

Here according to the quantity of timber available, and the demand, a separation into classes is advisable. Three classes for each kind will suffice. Among broadleaved trees, after oak, ash, elm, sycamore, alder and beech are most important and require separate classification.

B. POLES.

In this group poles used for building or other industrial purposes come first, then those used in agriculture. There is great variety in different districts as regards their dimensions: the following list gives only the more important classes, most of which, and especially the larger sizes, may be sub-divided into two, three, or even four sub-classes.

1. Building- and scaffolding-poles, rafters, always coniferous, 30—50 feet long and more, 100 pieces containing 200—300 cubic feet (6—8 cubic meters).
2. Telegraph-posts, 25—30 feet long, 6 inches across at top.
3. May-poles.
4. Ladder-wood, 20—40 feet long, 100 pieces containing 175—200 cubic feet.
5. Cart and agricultural implement poles, of both broadleaved and coniferous wood, 100 pieces containing 100—175 cubic feet.
6. Hop-poles, coniferous [except sweet-chestnut.—Tr.], 15—30 feet long, 2½—5 inches in diameter at 4 feet from the base, generally sub-divided into four or five classes. One hundred pieces contain 125, 80, 60, 35, 20 cubic feet.
7. Poles for fastening logs into rafts, 10—16 feet long.
8. Tree-props of different species.
9. Tree-stakes of different species.
10. Poles used for making hooping for casks.
11. Crate-wood and hurdle-stakes.
12. Fascine-stakes and hurdle-rails.
13. Bean-sticks, 10—15 feet long.
14. Fencing-stakes, 10—15 feet long.
15. Hedge-stakes [also walking-sticks and handles for umbrellas.—Tr.].

C. STACKED WOOD FOR SPLITTING.

As regards species ; oak, sweet-chestnut, alder and ash should be placed separately, also conifers.

Further separation into two or three classes, according to dimensions and fissibility, is also necessary. This group must always consist of sound wood. Stacked oakwood in the Palatinate is divided into two groups, stave-wood and wood for vine-props, the former into four, and the latter into two classes ; wood of other species and coniferous wood are each divided into three classes.

The round pieces of stacked timber are divided according to species into two classes of different dimensions. They are used for vine-props, pit-props, and in lengths of 5—6 feet for the manufacture of paper-pulp.

D. BRUSHWOOD.

1. Withes.
2. Osiers for basket-making.
3. Wood for brooms and pea-sticks.
4. Wood for fascines.
5. Thatching material.
6. Christmas-trees.

E. FIREWOOD.

1. Split billets, thoroughly sound wood, sub-divided into two classes according to size.
2. Crooked billets, sound but knotty.
3. Broken wood. Unsound split billets sub-divided into two classes according to the degree of unsoundness.
4. Round billets from stems.
5. Round billets from branches.
6. Peeled round billets from oak-coppice grown for tan.
7. Root-wood. This may be divided into two classes, when it sells well.
8. Large unsplit pieces.
9. Small split billets fastened with withes (Fr. *cotrêts*).
10. Faggots without twigs of larger wood from thinnings, under 2½ inches in diameter.

11. Branch-faggots.
12. Faggots of thorns, etc., from cleanings.
13. Heaped-up faggot wood.
14. Bark for fuel. The bark of silver-fir and spruce, when it is not required for tanning, is often stacked and sold for fuel. The bark rolls-up when thoroughly dried, and becomes less bulky.

The price-lists depend on the classification of the produce from a felling-area, so that there is a local price for every unit of produce. Such prices usually include the cost of conversion.

SECTION VII.—CLEARING THE FELLING-AREA.

1. *Explanation of the Term.*

The felled and converted material of different kinds, which during the process of conversion lies scattered over the felling-area, must be sorted and collected in a **temporary forest depot**. This is situated within the felling-area, in a valley or on a road leading from one, at the top of a timber-slide or sledge-road, or on the banks of a stream down which it is proposed to float the material. In no case, however, should the forest depot be so far removed from the felling-area that the material cannot be transported there by the regular woodcutters with the help of horses, or other simple means of transport.

Clearing the felling-area, therefore, means removing the material by dragging, carrying, sliding, or sledging to a convenient forest depot either within the felling-area or not too remote from it.

Whenever the material is to be removed to a **permanent depot** near the place of consumption or a railway-station, by means of more or less permanent means of communication, such as roads, slides, forest-tramways, streams, etc., all the measures required to effect its removal come under the head of **wood-transport**. Clearing a felling-area and transport cannot however be distinctly separated, and sometimes they are both carried on simultaneously by means of the same gang of woodcutters.

2. *Purpose of the Clearance.*

The wood is removed generally from the felling-area before selling it, for different reasons : first, to facilitate the estimation of the yield of the felling in quantity and quality ; then, for silvicultural reasons, and finally, to improve the forest revenue.

The first of these objects is obvious, and wherever the estimation of the yield depends on the clearance, that is clearly a part of the classification of the timber which has been already described (p. 254). The wood must be stacked in assortments in the forest depot, and the woodcutter who assists in removing it from the felling-area must understand the local classification of the material.

It is evident also that the removal of the material must act beneficially on the growing-stock, and that the preservation of the latter is much better secured when the forest-manager controls the clearance of the felling-area, than when the indifferent or careless wood-merchant deals with it, and is, therefore, admitted into all parts of the forest. Besides, in many conditions of the standing-crop it is essential that the converted material, which must remain in the forest until it is removed by the purchaser, should without delay be withdrawn from the felling-area, so that the latter may be left free and undisturbed for silvicultural operations. This is above all necessary in the case of coppice and coppice-with-standards, and also in natural regeneration-fellings in high forest.

The collection of the produce of a felling in depots accessible to ordinary carts, and which offer no difficulty of access to timber-merchants, must act beneficially on the prices and increase the forest revenue. Experience proves clearly that money carefully spent in this way will repay itself amply ; even if there were no other objection to the clearance being effected by the purchaser, it is evident that the forest-manager can do the work cheaper than the individual purchasers of different lots.

3. *Choice of a Forest-Depot.*

In order to secure the above objects as thoroughly as possible, the proper choice of an area to serve as a forest-depot is highly

important. Every forest-depot should be so situated as to be within easy reach of the timber-purchasers' carts, or other modes of transport, and so that the neighbouring woods may be liable to the least possible amount of injury in both the clearance and transport of the material ; it must also be in an open, airy or at least dry position, and should offer sufficient room for the different classes of material to be arranged conveniently for inspection by intending purchasers and by the forest staff. Wherever the logs have been barked, the depot should also be shady, so that cracking may be avoided.

Usually in plains, or moderately low mountain-ranges, the material is brought to the nearest road, or where this is not broad enough, into the forest bordering the road, including the ditches. Blanks on the felling-area, or in the clear-cutting system the felling-area itself, may be used as a depot, if there is no immediate necessity for restocking them. In higher mountain-ranges all the material from a felling-area must be brought down into the valleys, to the top of a slide, or to the banks of a stream. Usually this is done whilst the timber-work is proceeding.

Wherever great numbers of trees are felled yearly, it is in the interest of the forest-owner to set-aside permanent timber depots for the reception of the material from felling-areas, and to place the logs on supports keeping them from contact with the damp ground.

4. *Material to be Removed.*

In general, all wood should be removed from the felling-area, the sale of which would at least cover the cost of removal, when only the simple means at the disposal of the woodcutters are used.

All firewood and the smaller kinds of agricultural wood should be removed always before a sale ; whether, or not, this should be the case with the larger logs and butts depends chiefly on the nature of the ground. If the felling-area is nearly level, it is easy for the purchasers' carts to come up to the stumps of the felled trees to load and convey the heavy pieces of timber directly to their destination. If, however, the felling-area is on a slope, skilful woodcutters will find no difficulty in

removing the heaviest logs down to the valley below ; in such places it is indeed necessary for them to do so, for carts cannot then leave the roads, and the purchaser of the timber must not be allowed to slide the logs downhill to his carts. On sloping ground, therefore, all large timber is removed by the woodcutters from the felling-area. Where there is only a gentle slope, the removal of the timber from the felling-area will depend on the amount of protection necessary for the forest crop. In many such cases, it is sufficient to remove the timber to the nearest cart-track passing through the felling-area.

The mode of re-stocking the area to be adopted will also influence the matter. If the area of a clear-felling is to be re-stocked immediately, all the wood on it must be removed. In the case of natural regeneration, there are usually blanks in the felling-area on which the heaviest timber may be placed.

Wherever the purchaser undertakes to fashion the wood in the forest, as in the making of sabots, spokes, staves and other cloven ware, the worksheds should, if possible, be kept outside the felling-area ; the granting of the permit to prepare the wood should depend also on the acceptance by the purchaser of certain suitable sites for his work, provided such sites are available.

5. Modes of Clearance.

The felling-area may be cleared in various ways, which are more or less consonant with forest protection ; such as carrying, sliding, dragging, sledging, letting-down by ropes, using timber-chutes and rolling downhill.

(a) Careful Methods of Clearing a Felling-area.

i. Carrying.

Carrying is done chiefly by men, seldom by beasts, and is confined to the smaller classes of material, such as firewood, poles, branchwood and cloven-ware.

As carrying by men is very laborious and expensive, it is done for short distances only, especially when wood has to be

removed from young growth with the least possible amount of damage to the latter, or has to be taken a short distance uphill to a road ; also on very rocky ground, where no other means of transport is practicable. The woodcutter either carries the wood on his shoulder or piled on a frame on his back, or it is carried on a litter supported by two people. Logs and poles may be carried on the shoulders of several people [or suspended from rods resting on their shoulders as they walk in pairs.—Tr.]. In natural reproduction-areas, especially during the final stage in spruce or silver-fir woods, all branchwood should be carried and not dragged from the felling-area, as the latter plan does much damage to the young growth and predisposes it to attacks of weevils.

ii. *Removing Wood on Wheeled Conveyances.*

This is always a careful method of clearing a felling-area, but can be employed only where the ground is fairly level. The ordinary wheel-barrow may be used, to which a rope may be attached to economise strength in pulling. Horses or bullocks also may be used on fairly level ground, with the front or back pair of wheels of a timber cart. In this case the log is hung under the axle of the wheels, and this is the best method available for removing timber from young growth without injuring it. The use of portable railways (p. 386) is also a method as good, if not better, than the above. [A French method of raising logs on to carts is shown on p. 481.—Tr.]

In order to further the transport, sufficiently wide cart-tracks or paths may be cleared, which is specially advisable if young growth is to be traversed. In any case this method is far preferable to dragging the timber carelessly along the ground.

iii. *Dragging or Sliding along the Ground.*

In this method either men or beasts may be employed. Various implements are used by the workmen to expedite matters, such as the *krempe* (Fig. 161), or the implement shown in Fig. 160, resembling a boat-hook, and also used in floating timber, or the strong *hook-lever* with hook and ring

(Fig. 162), or ordinary levers. In the case of beasts dragging the logs, chains are used, which may be fastened to the logs by grappling-irons (Fig. 163), or by means of the slip (Fig. 164 for two horses or Fig. 165 for one). The short sledge (Fig. 172) may be used.

Before a log can be dragged or slid, generally it must be turned over, or rolled into the dragging-track; for this the hook-lever may be used as shown in Fig. 159. To bring a log parallel to the dragging-track, it suffices generally to place a



Fig. 159.—Hook-lever.

roller under its centre of gravity, when it can easily be turned in any required direction.

If a log is to be slid down by men, which evidently can be done only if the ground is sufficiently steep, it is brought into the sliding-track with its butt-end downwards, and then guided by the krempe at its butt, as it is forced to slide downhill by levers. The workmen who accompany it downhill release the log should it stick against any obstacle, and bring it down to the nearest export-road, or to level ground.

When beasts are used to drag the logs, such as horses, bullocks [in India, buffaloes and elephants.—Tr.], the ground must be level or only slightly inclined. The log is then held firmly, as in the Alps, by the grappling-iron, or a hole is cut in the butt of the log to which the dragging-chain is fastened. If the



Fig. 160.—
Floating-hook.

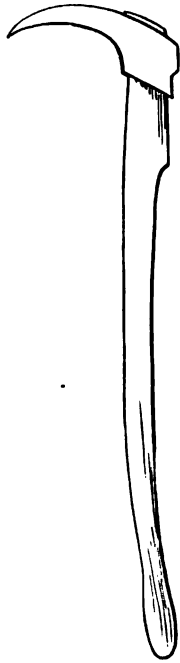

Fig. 161.—Krempe.



Fig. 162.—Hook-lever.

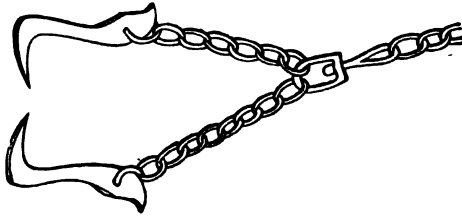

Fig. 163.—Grappling-irons.



Fig. 164.— Dragging-slip.



Fig. 165.— Dragging-slip.

ground is covered with snow, the logs are simply dragged along over it, or are fastened to the front wheels of a timber-cart, or to a sledge. In any case much labour is saved by slightly raising the butt-end of the log from the ground on a slip.

In the Bavarian Alps a simple arrangement, the dragging-shoe (Fig. 166), has proved useful. It hinders soil erosion and the up-rooting of plants. The shoe is placed under the front of the log, which sticks on the iron points, if it gets loose during transport, the other pointed iron is driven into the log.

In most forests, sliding or dragging are the usual methods employed for clearing the felling-area ; on slopes by men, and

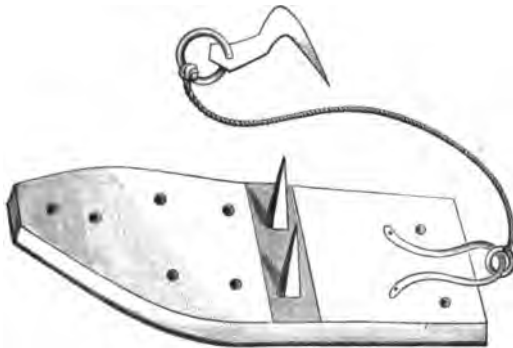

Fig. 166.—Bavarian dragging-shoe.

on fairly level ground by animals. In the case of reproduction-areas, and especially those in coniferous forests, dragging should be done only with great care, the log not being allowed to roll ; there should also be sufficient snow on the ground. Dragging injures young plants more than any other method and greatly exposes young conifers to attacks of weevils. It must, however, often be employed even when the ground is free from snow, but in such cases it is not sufficient to slide or drag the logs along cleared tracks ; a pair of high wheels also should be used if the ground is not too steep. Logs should also be rounded at their butts when dragged or slid, as then they do less damage.

When the ground is not stocked with young growth, there

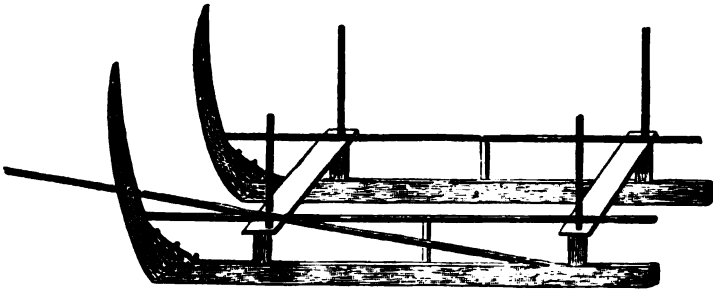

Fig. 167.—Murgtal Black Forest sledge.

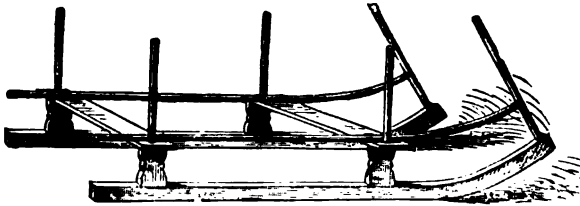

Fig. 168.—Middle Rhine-Valley sledge.

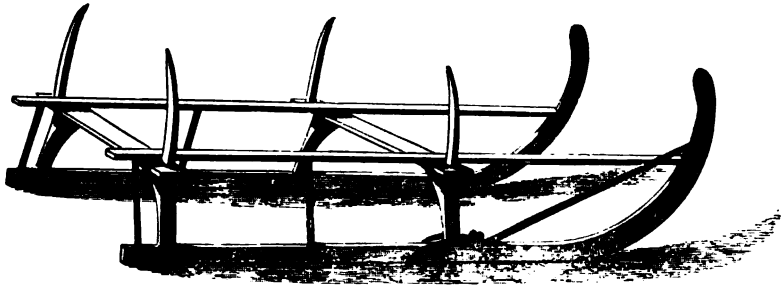

Fig. 169.—Alpine sledge for butts 10–15 feet long.

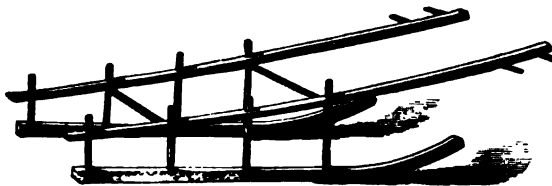

Fig. 170.—Southern Black Forest sledge.*

* Gayer recommends the sledge shown in Fig. 170 on account of its lightness and simplicity, and because by pressing on its runners in front, it can be easily checked in speed.

can be no objections to sliding or dragging timber from the felling-area.

iv. *Sledging.*

Sledges may be used for clearing the felling-area, and then on frozen ground or temporary sledge-roads, as distinguished

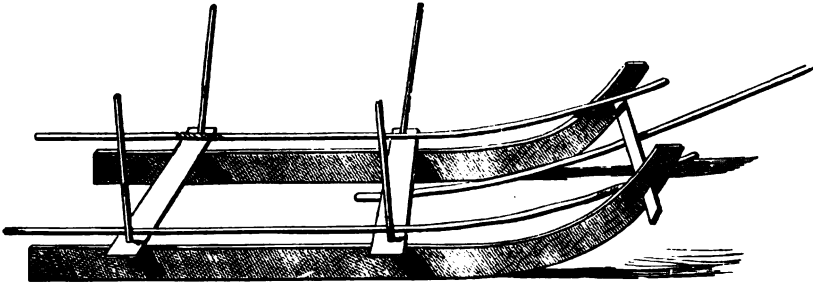

Fig. 171.—Moravian sledge.*

from permanent sledge-roads, which will be described under "Wood-transport."

(a) **Construction of Sledges.**—The mode of construction of ordinary wood-sledges may be seen from the annexed figures, different forms being used in various European countries and districts, but it has not yet been decided which is the best form to adopt under various circumstances.

[Two forms of sledge are in use in the N.W. Himalayas for transport of railway-sleepers and firewood, and have proved very useful. As the oak runners of these sledges become worn, soles also of oak are applied to them.—Tr.]

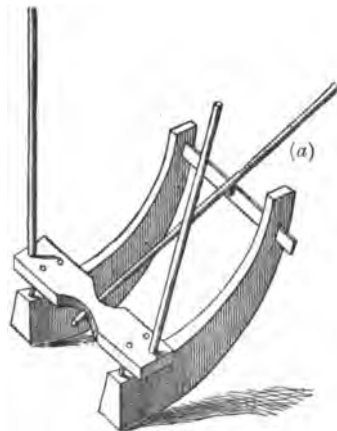

Fig. 172.—Moravian short sledge.†

* In this sledge, the load rests distinctly on the runners, and its construction is very simple.

† In this short sledge firewood is placed between the vertical arms and the shaft (a).

The requisites for a good sledge are lightness, strength, and dimensions allowing for a load which one man can transport.

(b) **Sledging-tracks.**—Wherever sledges are used for the removal of wood, a serviceable track must be made, which differs according as the sledging is done in summer or winter.

For winter-sledging on fairly level frozen ground slightly covered with snow, a path is soon got ready after removing a few obstacles. On slopes, the case is similar, provided there are no holes, ravines or slight eminences in the way. Ravines and holes may be filled with branches or faggots, or billets of firewood may be piled up in them till they are filled.

The track is then covered with snow, over which the sledge

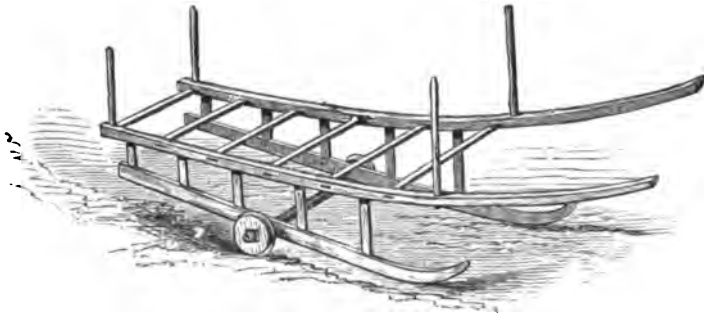

Fig. 173.—Barrow-sledge.*

passes; this may be necessary when the wind has blown away the snow, whilst in other cases, it may have drifted too deeply, and part of it requires removal. In many districts woodcutters show considerable ingenuity in constructing temporary sledge-roads. Once the rest of the wood has been removed, the billets on the road are lifted and brought down on sledges.

Whenever the snow is deep, the track must be beaten or trodden down. Where the snow on the felling-area is over two feet deep, the removal of the wood must be suspended, for it costs too much time and trouble to hunt for the pieces, and many of them would be overlooked. A winter with little

* The barrow-sledge is much used in the Upper Schwarzwald, either on snow, or along cart-roads. It is, however, used chiefly on specially prepared paths.

snow is, however, worse than deep snow, for then much time is spent in placing snow on the bare parts of the track, or



Fig. 174.- Vosges. Summer-sledging.

in preparing an ice-path. Until some snow has fallen, the work of clearing the felling-area must be often suspended.

During summer, sledging can be done only on sloping ground, and even then is not always practicable; for on

slopes which are otherwise suitable, a sledge-track can often be made only with excessive trouble. This is often the case on rocky ground, or where the soil is deep. On slopes, however, which are covered with dead needles, or moss and herbage, sledges may run freely, especially over silver-fir and Scotch-pine branches, spruce being not so suitable. If then any hollows in the track are filled with billets covered with branches and litter, or a kind of tramway made with round billets over the more difficult ground, sledging may be effected with great saving of labour, and is consistent with the protection of the young growth. It is, however, practicable for short distances only (Fig. 174).

(c) **The operation of sledging.**—In all sledging operations, the workman stands in front between the horns of the sledge, which he holds in both hands, so as to draw the sledge or stop its too rapid progress.

Wherever the ground is even, or only slightly inclined, the sledge must be dragged, and the greater the angle of inclination, the less this is necessary; if then the track be smooth, with a gradient of 1 in 20 (5 per cent.), usually the workman has only to guide the sledge. As the gradient increases, he has to hold the sledge back; with gradients from 1 in 16 to 1 in 12 (6 to 8 per cent.), a man can do this without much difficulty, but with steeper gradients brakes must be used. Thus on steep inclines, the workmen have iron spikes attached to their boots to give them a good hold on the ground. [In the Himalayas, softwood sleepers are used down steep inclines for the sledges to run on, and hardwood for low gradients the pieces being closer together in the latter case, this with the use of sand is found better than any brakes.—Tr.]

Brakes may consist of bundles of faggots in which stones are placed which are dragged after the sledge by an iron chain. Several such faggots are often linked together, attached by short chains close behind the sledge. Round or split billets of wood may serve the purpose, instead of faggots. Hoops made of twisted withes may be hung over the horns of the sledge, and let down under the sledge-runners on steep slopes, thus causing a great increase of friction. The iron hook and lever (Fig. 175) is used also in many Alpine sledges

as a brake. In Moravia, the very small sledges (Fig. 172) support only a small part of the load taken down at once; the rest is fastened in bundles and dragged behind the sledge, so as to act as a brake. As the track varies in steepness, occasionally parts of the load have to be left behind: the man takes what he can to the nearest steep part of the track and then returns for the rest, he then goes on with the whole load till he comes to another place where the gradient is insufficient, and some again has to be left behind. Such a mode

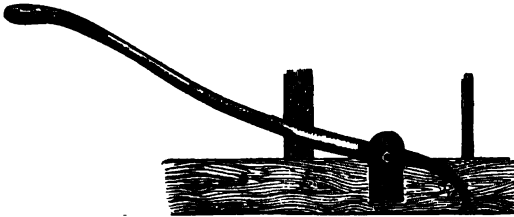

Fig. 175.—Sledge-brake.

of sledging is most suitable with gradients from 1 in 4, to 1 in 3, (25—30 per cent.).

It is evident that besides using some form of brake, the workman must use his own strength and press his spiked boots into the track at steep places.

(d) **Sledging without a regular track.**—Generally, sledging except on sledge-tracks, is confined to the transport of fuel or charcoal-wood. This is either split and piled transversely between the sledge-uprights, or if brought down in round pieces often of double the length of the billets, these are placed lengthways along the sledge in a pyramidal pile and fastened to the sledge by short ropes or thin chains.

v. *Sliding Logs by means of Ropes.*

Thick ropes, 30—60 feet long and $1\frac{1}{2}$ —2 inches thick, are used for sliding logs down sufficiently steep inclines.

The method of attaching rope to the log is shown in Fig. 176, or a hook may be attached to the rope and inserted into a hole cut in the butt-end of the log. According to the position of the log on the ground, it may be let down with its butt-end

or smaller end first. After the rope has been attached to the log, it is wound once or several times, according to the weight of the log and the gradient of the ground, round the stem of a neighbouring tree or stump, and let down by gradually loosening the rope. It is accompanied by 1 to 3 men, who guide it past obstacles, or stop it with the krempe (Fig. 163)

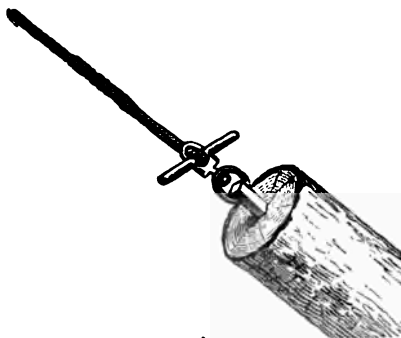

Fig. 176.—Sliding with a rope.

or lever (Fig. 164) freed from the kanting-hook, and direct its course among the young growth. Once the length of the rope is run-out, the log is held firmly by the men by means of krempe, until the rope has been wound round another tree, and the process is repeated until the log has reached its destination.

This method is employed extensively in different parts of the Black Forest, where up to 10*d.* a cubic meter (35 cubic-feet) is paid for the removal of the logs; this expenditure is amply covered by the higher price thus secured for the timber.

[Care must be taken that the rope is not wound round valuable standard trees intended to remain for several years on the felling-area, as their bark is then damaged and unsoundness may ensue.—Tr.]

(b) Injurious methods of clearing a Felling-area.

In the following methods of clearing a felling-area, the wood is no longer under the control of the workman, but is left to itself while it moves.

i. *Rolling wood from the Felling-area.*

This is a method of removal only permissible over unstocked areas, as in the clear-cutting system with artificial reproduction. In such a case it is an expeditious method if the gradients are not too great. When the gradient is considerable, it becomes

dangerous to human life. In spite of this danger, however, workmen prefer it to any other method.

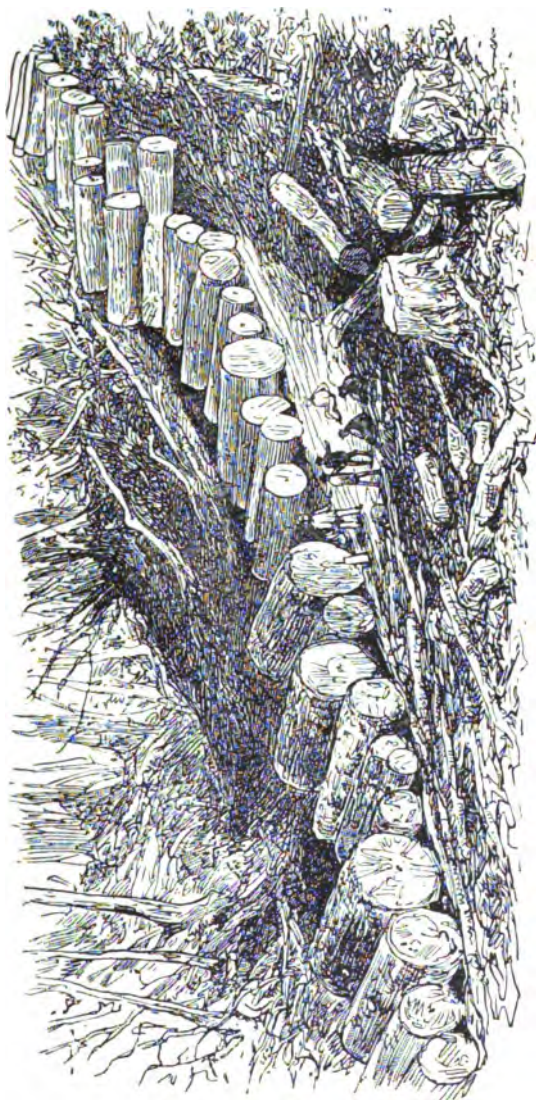

Fig. 177.—New Zealand rolling-road leading to a shoot. From the "Graphic."

[Rolling is largely employed in Assam in removing short Sál (*Shorea robusta*) and other butts from the forest to the

river-side. A rolling-road used in New Zealand for *Dacrydium cupressinum* is shewn in Fig. 177.—Tr.]

ii. *Throwing wood from the Felling-area.*

Another method employed for short round butts intended subsequently to be split into cordwood, is to throw them down hill topsy-turvey from terrace to terrace. A firm surface to the ground is necessary, such as snow with a hard frozen surface, on which the wood may slide or roll as well as turn over. It may also be done in wet weather, but deep snow greatly impedes the descent of the logs.

The krempe is usefully employed in setting the butts in motion. The practice can be employed only over unstocked areas. It is rendered more practicable when branch-wood from the felling-area is piled on both sides of the line selected for the descent of the butts, thus keeping them well together.

iii. *Sliding timber.*

This is the method of allowing logs and butts to slide down-hill by their own weight. Their butt-ends are rounded and turned down-hill. Any depressions in the hill-side are speedily filled with butts and logs, and the workmen try to keep these lying parallel to one another in the direction of the greatest slope, so as to assist the other logs in sliding over them.

This method is employed largely in the Austrian Alps, and in Franconia. Wherever on the hill-side the gradient of the slope is insufficient for any further chûting of the logs to be done, they are turned at right-angles to their previous direction and rolled by means of the krempe to the next steep slope, where sliding can be recommenced. This method is illustrated in Figs. 178, 179, the fall in the latter case being from the top of the diagram.

iv. *Dry timber-chules.*

These are narrow ravines among mountains, with steep sides, and are barred by means of a horizontal log, behind which a number of short, round logs are collected and let loose down the ravine by cutting away one end of the bar. This method of removal is employed in the Alps, for short distances,

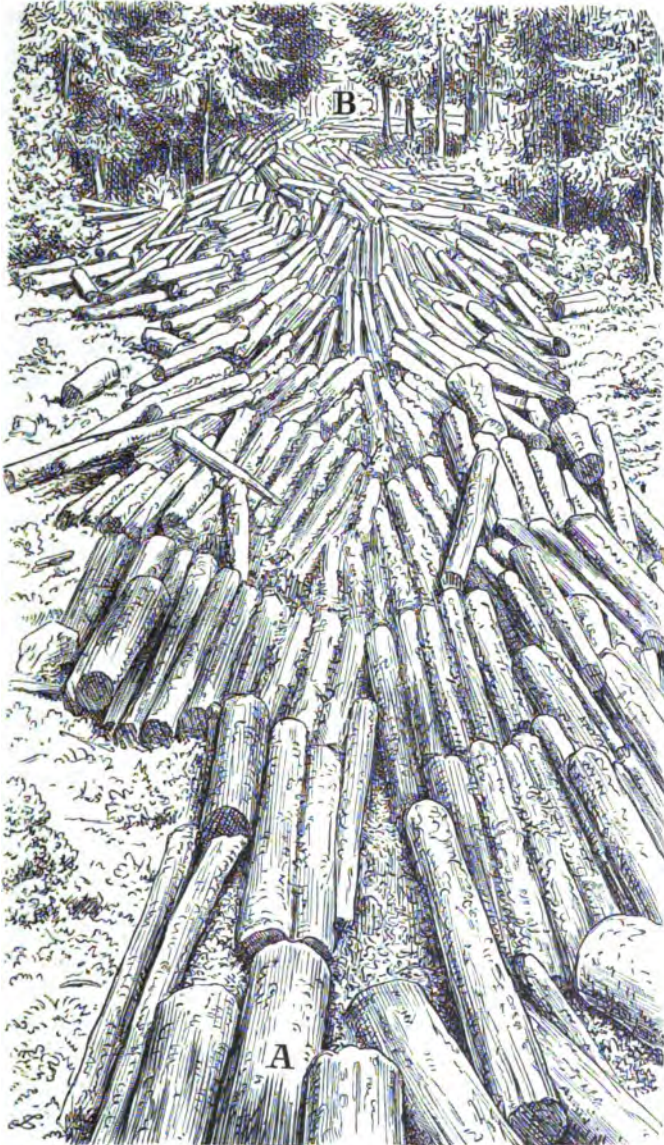

Fig. 178.—Sliding timber from A to B.

where there are ravines suitable for the purpose, and other methods of removal are too difficult. It may be termed a **dry timber-chute**.

In some cases the bed of the ravine contains a mountain-torrent, which may be dammed temporarily until there is a sufficient head of water to carry the logs down, when the dam is opened. This is termed a *wet timber-chute*.

Evidently, wherever timber is left to fall downhill by its own weight, and without being under the control of the workmen, much breakage and loss of bulk by friction must ensue; so that these methods will be adopted only where more careful methods are impracticable or too expensive.

6. *Season for Clearing the Felling-area.*

The season for clearing a felling-area depends on that of the felling, and on the mode of removal employed, as well as on the subsequent transport of the timber, and the available labour-force.

It is a general rule to clear a felling-area as soon as possible after the conversion of the felled material, and bring the latter into suitable places for its preservation and seasoning. This is especially urgent in coniferous forests, where there is much danger from beetles. Rapid removal of the material is also necessary on natural regeneration-areas, and other areas stocked with young growth. The mode of removal employed should be considered also, depending as it does chiefly on the configuration of the ground. In plains and low mountainous districts, there is no reason why the removal should not follow immediately on the conversion of the wood. In high mountain-districts, it is frequently necessary to await a fall of snow before clearing the felling-area, and all that can be done in summer is to convey the wood to the nearest valley, or road, and proceed further with it during winter.

It is evident that the clearance of regenerated areas demands the greatest care, especially when long logs are to be removed. The spring, just before the buds shoot, is then the best season, the young plants being less brittle than in winter, even with a moderate snow-covering. If, however, the snow is deep and firm, and it is possible to do the work, the clearance should be effected in winter.

The season of removal depends also on the subsequent transport of the timber. In plains, the duration of frost in winter

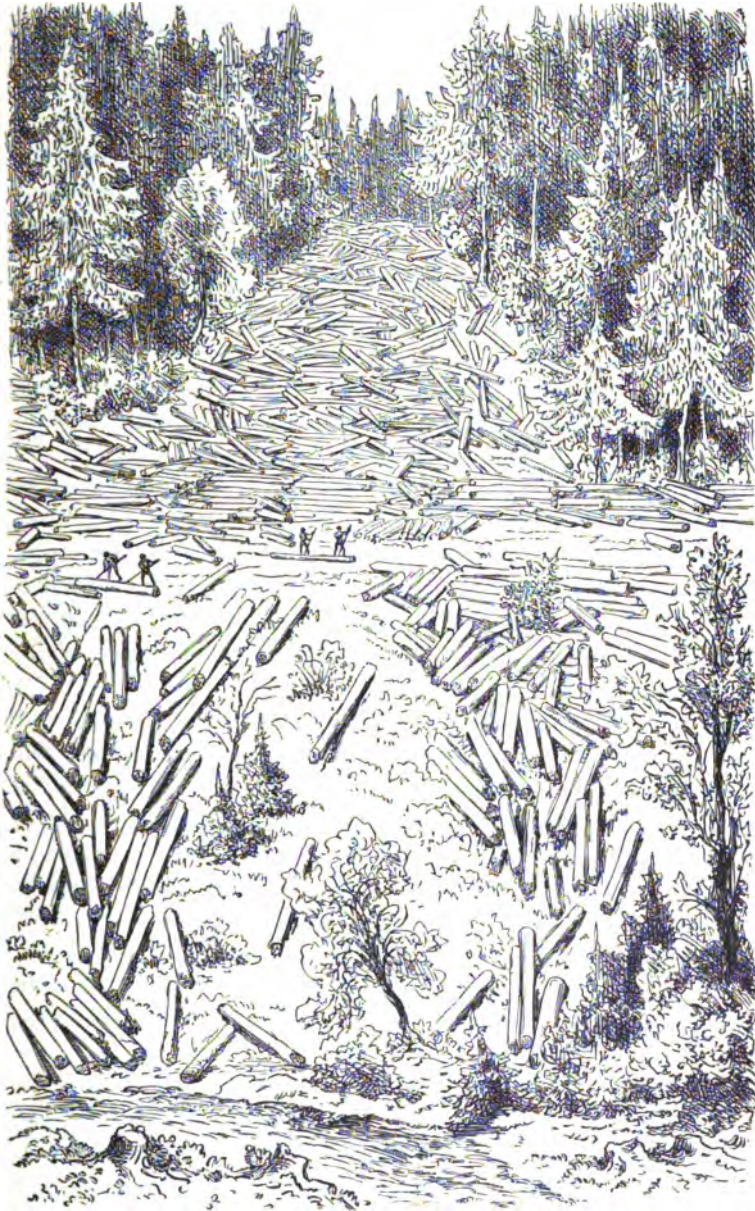

Fig. 179.—Sliding and rolling logs in Franconia.

greatly affects the transport. If the wood has to be floated or rafted to any distance, it is often necessary first to allow it to become thoroughly dry, especially where the streams are shallow; thus $1\frac{1}{2}$ years may elapse between the felling and the arrival of the wood at the saw-mills, which clearly involves great risk to the quality of the timber. In such cases the best logs should be removed speedily from the forest to airy forest-depots.

7. *General Rules.*

The following general rules apply to clearance of the felling-area:—

(a) All wood should be removed, the sale of which will repay the cost of removal; this may be expected always unless prices have gone down most abnormally.

(b) All wood lying in places inaccessible by carts, such as ravines, rocky ground, swamps and steep slopes, should be removed. In the case of dead wood, clear-cuttings, thinnings, etc., in flat or slightly hilly ground, the material is frequently left *in situ*, to be removed by carts, but even in such cases the collection of the wood by the proprietor often increases the forest revenue.

(c) Wherever there is a crop of young growth, as in all secondary and selection fellings, extraction of standards from younger wood and where trap-trees for beetles are felled, the wood should be removed at once from the felling-area. If, in such cases, the heavier logs are not removed at once, as on fairly level ground, all the rest of the material and especially the firewood should be removed as soon as possible by workmen under the control of the forest-manager.

The logs left on the felling-area should be raised above the ground on pieces of wood and removed as soon as possible by purchasers.

(d) The forest-depot and the paths leading to it must be selected by the forest-manager before commencing the felling, and all wood from the felling-area brought to the depot without delay. In mountainous districts, where there is scarcity of room, vacant sites for stacking timber are provided by widening the roads leading downhill at suitable places.

(e) The method of removal of the wood to be adopted must be prescribed beforehand and adhered to as much as possible. All unsilvicultural methods should be avoided, and employed only in high mountain-districts, where the timber cannot otherwise be removed.

(f) The greatest care must be taken of the young growth when the wood is being removed, and tracks, along which this is permitted, should be selected beforehand by the manager. Great care must be taken not to injure the bark of standing trees during the removal of the wood, as this frequently causes unsoundness and greatly depreciates the future value of these trees.

On fairly level ground, if there is no snow, the heavier material should be removed by means of horses and a pair of wheels, especially through young coniferous growth. On slopes, the groups of young growth should be surrounded by heaps of branches to protect them. Timber may be removed across natural regeneration-areas without any serious damage, but this is undesirable in the case of artificial plantations.

(g) The wood should be removed in assortments, and then stacked at the forest-depot. Care should be taken to economise space in the latter, and that the piles of material on hillsides are stable. [In some cases terraces must be carefully made for locating the stacks.—Tr.] All small timber should be piled in hundreds or fifties, and butts and logs in lots of five, ten or more. Heavier pieces which would otherwise remain some time on damp ground should, as soon as possible, be raised on supports above the ground.

(h) Each party of woodcutters must remove and pile its own wood separately from that of other parties, in order to facilitate payment for the work.

(i.) Removal from the felling-area and transport to the sale-depot are frequently done simultaneously; in such cases the work may be entrusted to a contractor under strict rules to prevent damage.

It often happens in the plains, in the case of clear-fellings, that great numbers of logs have to be removed, and sometimes this may be done best by means of contractors' horses, mules, or bullocks. In high mountain-regions, removal and

transport are done generally by contract [as in Indian fuel-forests—Tr.].

SECTION VIII.—SORTING THE CONVERTED MATERIAL AND FIXING THE SALE-LOTS.

The first rough sorting of the material from the felling-area is done when the workmen bring the pieces to the forest-depot, and this classification will hold for all the heavier pieces, logs, butts, etc., which cannot be moved about in the depot. The men therefore must take the greatest care to arrange these pieces properly, once for all. Pieces, however, which can be moved easily by the men, may be arranged somewhat more carefully at the depot itself; this refers chiefly to firewood and small timber. Every kind of material is arranged in small lots, which can be measured easily and their value estimated. This arrangement should be commenced as soon as sufficient stuff has come down from the felling-area, and continued *pari passu* with the conversion and clearance of the latter, so that it may terminate immediately after the felling-area has been cleared.

The sale-lots may be either in **separate pieces**, by numbers of pieces, or in **stacked volumes**.

1. *Single Pieces forming a Lot.*

All large pieces, such as logs and butts, are measured separately, and even if several such pieces are sold together, the rule is to estimate the value of each piece separately.

In the case of broadleaved timber, hardly any two logs or butts are alike, and each piece should be sold separately. Coniferous pieces, on the contrary, are far more regular in quality, form and dimensions, especially the butts intended for saw-mills; a moderate number of similar pieces may therefore be arranged in a lot. Places in which they are to be arranged should therefore be shown to the woodcutters before any wood has come down to the depot.

In forests subject to inundations, logs should be secured with cords or wire to posts driven into the ground.

2. *A Number of Pieces forming a Lot.*

All inferior timber, such as poles, etc., which resemble one another sufficiently, should be placed in lots of 25, 50 or 100. A lot of hop-poles or bean-sticks of first or second quality is arranged easily, an average piece of each kind being selected to guide the workman. Assortments of small timber should be arranged therefore in the depot, in classes and sub-classes. This work will be done the more easily if the woodcutters sort them carefully during the clearance of the felling-area. It is everywhere customary to place small poles and saplings in hundreds, and the larger kinds, and those for which there is only a moderate demand, such as scaffolding-poles, ladder-wood, cart-poles, etc., may be placed in fifties or quarter hundreds.

They should be placed with their thick ends towards the road between stakes

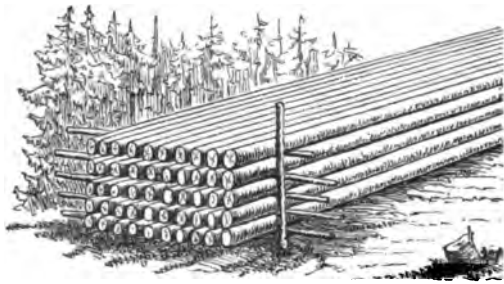

Fig. 180.—Poles arranged in tens.

driven into the ground. The smaller kinds—bean-sticks, hurdle-wood, etc.—may be fastened together in lots of 25. Poles may be arranged conveniently by tens, a small rod being placed under the thick ends of each ten poles, in order to facilitate removal (Fig. 180).

3. *Stacked Wood.*

All firewood, and as a rule all branch-wood, cloven-wood, or fascines, should be measured by stacked volume, and therefore piled in regular stacks; a much more difficult matter than the simple one of piling poles, and it must be described in detail.

(a) **Shape and Size of the Stacks.**—The stacks of firewood, billets, etc., are usually rectangular parallelepipeds, of different

dimensions in different countries; in Germany, Switzerland, Austria, France and Italy the unit is generally a stacked cubic meter (*Raummeter* in German, or *stère* in French*).

It is, however, usual, even when the wood is measured in stacked cubic meters, to place three or four stères of wood in a stack approaching in volume to the old customary measures; the usual number is then 3 stères, but 1 and 2 stères are sometimes employed. The normal length of the billets in a stack is 1 meter, but especially in the case of cloven timber this may be varied. The length of the pieces is considered as the width of the stack, and its other dimensions are termed **length** and **height**. Thus, for 1 meter of width, we have for

| | Meters. | Meters. |
|----------|-------------|-----------|
| 4 stères | { 2.67 long | 1.50 high |
| | { 2 „ | 2 „ |
| 3 „ | { 3 „ | 1 „ |
| | { 2 „ | 1.50 „ |
| 2 „ | { 2 „ | 1 „ |
| | { 1.6 „ | 1.25 „ |
| 1 „ | { 1 „ | 1 „ |

[In the fuel supplied to the British army at Chakrāta in Northern India, the stacks are 21 feet long \times $5\frac{1}{2}$ feet high and 2 feet wide; this is supposed to contain 200 cubic feet, 1 foot in length and $\frac{1}{2}$ foot in height being allowed for shrinkage.—Tr.]

The stacks should not be too high, especially on sloping ground and with coarse split roots or heavy wood, and usually the height should not exceed 5 feet; high stacks only increase labour and are liable to fall.

The usual size of brushwood-faggots is, with the exception of fascines, of the same girth and length as an ordinary split billet.

(b) **Site for Stacks.**—In selecting the site of a stack, damp places must be avoided; a ridge is preferable, if available.

As a rule, two sufficiently long stakes are driven vertically

* [In France, the ordinary cord 9 ft. \times $3\frac{1}{2}$ ft. \times $2\frac{1}{2}$ ft. = 3 stères. (The French foot = 1 ft. $1\frac{1}{4}$ in., English measure). In England, the cord is either 216 c. feet = $12' \times 6' \times 3'$ and is then called a fathom and nearly = 6 stères, or 108 c. feet = 3 stères, or 72 c. feet = 2 stères, as in America.—Tr.]

into the ground at the same distance apart as the length of the stack. In order to hold the pile of wood firmly it is better to have at each end of the stack two stakes, which must be strong and driven by mallets deeply enough into holes made in the ground by crowbars. Opposite stakes may be tied by withes or strings, passing through the piled wood to prevent it from forcing them apart, or side-supports may be applied to the stakes.

On an incline, the distance between the stakes must be measured horizontally, and the top of the stack should be parallel to the incline. It is better not to substitute a standing tree for one pair of the stakes, as the roots will prevent there

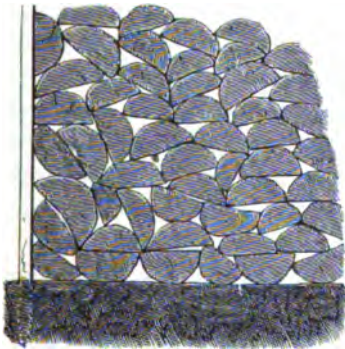

Fig. 181.

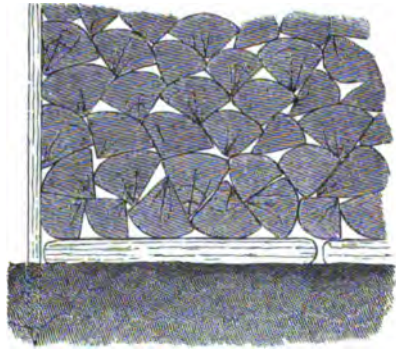

Fig. 182.

Stacking firewood.

being a level base for the stack, and irregularities in the height of the latter may follow.

(c) **Stacking the Wood.**—The workman should pack the wood as closely as possible. The base of the stack (Fig. 182) is made by laying several pieces lengthwise on the ground on which the rest of the wood is piled transversely; this precaution should be adopted whenever the wood has to remain for a long time on wet ground, otherwise the lowest billets may be forced into the ground and rot. On dry, firm soil, this arrangement may be dispensed with; the largest billets are then placed transversely, with their curved sides downwards, directly on the ground (Fig. 181), and the stack is completed with wood of the same quality, the larger pieces being always piled first to

ensure stability: at the same time, the men should pile the wood in such a way as to keep the top of the stack continually horizontal.

In order to pile the stacks closely, and also to protect the wood as much as possible from rain, it is better to place the curved sides of the billets above and their points downwards (Figs. 181 and 182), except in the lowest row. The front surface of the stack also should be quite level and vertical, and as the billets are of different thickness at the two ends, they should be placed alternately with their thick and thin ends at either face of the stack. The first cord binding the stakes should be placed at a height of $1\frac{1}{2}$ feet (half a meter), and the second at 3 to 4 feet (1 to $1\frac{1}{4}$ meters).

Stacking stump-wood is most difficult, as the shape of the pieces is so variable. Split pieces of small stumps are placed in the ordinary direction, but the larger pieces have to be arranged according to the skill of the operator, so as to fit in with the others. Spaces that cannot be otherwise stacked should be filled in with broken pieces and small roots, but round pieces should not be used for this purpose; a stack of stump-wood should contain nothing but pieces of stumps and roots.

When the workman has raised the stack to nearly its proper height, he should measure it carefully so that the proper height may be attained, but not exceeded. To ensure this, it is often necessary to finish the top of a stack of split billets with a layer of round ones.

Stacks should, if possible, be placed alongside one another in long connected rows. This economises space and secures the stacks from being overturned. In case the firewood has to remain over winter in the forest, the long stacks are, if possible, placed in parallel rows, with intervals between them narrower than the length of the billets, and the topmost pieces are arranged to form a complete roof over all the stacks.

(c) **Shrinkage.**—As green stacked wood shrinks while drying, and if not removed for some time will lose its bark, in many countries, such as Bavaria, Switzerland, etc., it has become customary to increase the height of the stacks, so as to allow for shrinkage. In Prussia and other German

countries, this is done only when there is a long interval between the stacking and the sale of the firewood, but in Wurttemberg and Hesse no excess height is allowed.

This excess height is as follows in different countries:—

| | | |
|-------------|-------------------|------------------------|
| Prussia | $\frac{1}{25}$ th | of the regular height. |
| Bavaria | $\frac{1}{15}$ th | ” ” |
| Switzerland | $\frac{1}{10}$ th | ” ” |

Considering that the shrinkage of the billets does not depreciate the heating-power of the wood and that its total amount varies greatly according to circumstances, such as the interval between stacking and sale, the species of wood, the position of the stack, the degree of splitting, etc., and that no excess is allowed for shrinkage in the case of timber, it is advisable not to allow for it in firewood except where legal rights to that effect have arisen. It has also been proved by Böhmerle* that there is scarcely any change after a year in the height of a stack of firewood, as warping counteracts the shrinkage, so that according to his experiments, its height decreases only by about an inch in a year.

(d) **Stacks of Cloven Timber.**—In stacking cloven timber, great care must be taken to separate the better kinds from inferior timber, and not to suffer any unsound or knotty wood in a stack. In the case of oakwood, all sound split pieces must be included in stacks of cloven timber, and oak-firewood stacks should not contain a single sound piece which can be classed as timber.

Deviations from this rule are justifiable only where there is no demand for inferior classes of cloven wood. In the Bavarian Forest, the detailed assorting of coniferous cloven timber is done partly during the floating, the floating workmen selecting from out of the water the good pieces, that are used for sieve-frames, match-wood, etc. The employees, who are sworn to deal fairly, stack this wood on the bank and value it as timber.

(e) **Stacking Faggots.**—Faggots are collected into piles each containing 25, or a multiple of 25 faggots. They are put sometimes horizontally, but keep much better standing,

* “Das waldtrockne Holz,” Vienna, 1879.

three faggots being laid in a pyramid and all the others placed leaning against them.

When faggots are not prepared, the branchwood is generally

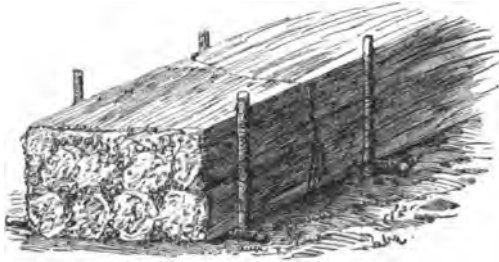

Fig. 183.—Piled branchwood.

piled in heaps, and may be cut into equal lengths for this purpose. Sometimes it is piled, as shown in Fig. 183, and tied roughly in bundles to facilitate transport.

(f) **Special men employed.**—Ordinary woodcutters are not allowed to stack firewood, as in their own interest they would make as much of it as possible. Special men are therefore employed, who are well known to the forest-manager and are sworn in to be faithful. They should pile the wood prepared by each party of woodcutters separately, so that their earnings may be calculated.

3. *Protecting the Forest-Depot.*

The supervision and guard over the material at the depot is facilitated greatly if it be arranged according to an easily recognised plan. It must be placed so that the purchaser's carts can approach each lot as nearly as possible. This is more easily attained when the conversion and sale of the timber precede that of the firewood, and then the billets may be stacked in long rows along the roads or rides, with the faggots behind them.

As a rule, the mode of arrangement of the depot depends chiefly on the area available, but the forest-manager should always endeavour, like a trader, to secure a good display of his wares.

When the last firewood stack is ready, and the felling is thus completed, all chips, broken pieces and other waste material may be collected and distributed among the woodcutters. In certain localities, the twigs and branchwood may be spread over the area, either as in the Alps to protect the young growth against cattle, or as in *jhumes*, to facilitate the burning of the surface before sowing an agricultural crop.

SECTION IX.—ESTIMATING THE YIELD.

1. *Numbering the Lots.*

As soon as the felling operations are over, the amount of material produced must be calculated and its value estimated. If the clearance of the area and the transport are carried on simultaneously, and the wood is removed a considerable distance from the felling-area to valleys or rafting stations and collected there, the estimation is effected at these places, and in the case of summer fellings often not till the following spring.

Each log or butt, each pile of 100, 50 or 25 poles, etc., each stack of firewood, and every 25 faggots, form the several

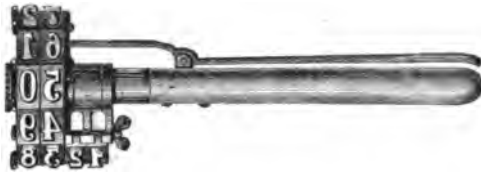

Fig. 184.—Göhler's numbering hammer.

lots. Current numbers are, therefore, affixed to each separate lot, to distinguish them from one another.

In order to render the control of timber-export effective, it is better that one series of numbers should serve for a whole forest-range, or for a group of fellings the produce of which passes in a certain direction. In order, however, to obviate the inconvenience of using very high numbers, each class and sub-class of produce is numbered separately, so that there are several series of numbers each beginning with No. 1, for the logs, butts, hundreds of poles, stacked wood or faggots. In Prussia and some other countries, each species of wood, such as beech-logs, oak-logs, etc., receive different series of numbers.

The numbering may be done by hand, or by means of a piece of softwood charcoal, a red pencil or by Faber's numbering chalk, the marks of which last for two years. A paint brush and black oil-paint also may be used with or without stencil-plates. Certain steel dies have been invented, of which Göhler's

In the remarks column, entries may be made as to where the lot is situated, for instance, on the upper, middle or lower road, through the depot, or felling-area.

The numbering book for firewood should run as follows :—

| No. of lot. | Species. | Class. | Quality. | Quantity. |
|-------------|----------|--------|----------|-----------|
| | | | | |

2. *Estimating the Quantity of Produce.*

The quantity of produce from a felling-area may be estimated in different ways, according to the cubic contents, or dimensions of the lots.

(a) **Each Lot a Separate Piece.**—When each lot is formed by a separate piece, the volume of the pieces must be estimated separately, either by calculating their cubic contents, or their dimensions.

i. Cubic Contents.

In Germany, France, and some other countries, the cubic contents of timber are always measured by the cubic meter, but in England, India and North America by the cubic foot. Without complicating the procedure by considering logs as truncated paraboloids, the simple method is adopted always of multiplying the sectional area at the middle of the log by its length. The cubic contents alone, however, are no exact indication of the value of a log, its length and thickness and the diameter of its smaller end must be also given.

It is customary on the continent of Europe to measure the length of logs in meters, and even decimeters (m. 0·2, 0·4, 0·6, etc.); the diameter in centimeters, and the cubic contents in cubic meters to two decimal places.

[In English measure, the length of logs is given in feet; the diameter, or quarter-girth, in inches, and the volume in cubic

feet without fractions. Squared balks of valuable wood like mahogany are, however, sold by the superficial foot.—Tr.]

Whether timber should be measured with or without bark depends on local custom. In the case of winter-fellings, the bark is included, and wherever summer-felled or other peeled wood is measured, 12 to 15 per cent. is added to the cubic contents to allow for the absent bark. This is done because the yield of the forests in the working-plan is estimated with the bark on the trees, but the German timber-trade is most anxious that bark should not be included, and this method Gayer strongly recommends for adoption everywhere in the interests of uniformity.

A universal system of measuring timber without bark presupposes that the bark of logs is removed at the measuring point, and that no addition is made for peeled wood. In the case of coniferous logs, the difference in diameter between barked and unbarked trees is $\frac{3}{4}$ inch on the average, somewhat more in the case of pines, and for logs under 10 inches in diameter, less than $\frac{1}{2}$ inch.

In the case of roughly barked broadleaved trees, such as oak and ash, the bark is 12 to 15 per cent. of the total volume; in the elm, up to 18 per cent. and more; the birch 11 per cent.; the Scotch pine, 11 to 15 per cent.; spruce logs and blocks, 12 to 13 per cent.; silver-fir ditto, 17 per cent. and more. It should be noted that on good soil with a dense growth, the bark is least, whilst in unfavourable localities and open woods it is at a maximum.

Whenever stems are sold at their full length, the measurement for timber stops naturally where the small end becomes less than the minimum in timber-classes, and the rest of the log can be measured only as firewood.

ii. *Measurements according to Dimensions.*

In some localities, where there is an extensive trade in logs, it has been for a long time customary to arrange them in classes which do not depend on their cubic contents. Thus, for each class (*Holländerholz*, etc., of the Black Forest), a log of average dimensions is assumed as a **standard** and by its

value that of all other logs in the class is regulated, according to variations in length and thickness at the butt-end.

In the Kinzigtal of the Black Forest, which has been renowned for centuries for its fine logs, a silver-fir log 20 meters (65 feet) long and 46 centimeters (18 inches) at the butt-end, is considered the standard.

In many regions of the Southern Alps, in the same way, butts 12—15 inches in largest diameter are considered standards. Thus traders speak of 2 pieces of 10—12 inches, 4 of 8—10 inches, 8 of 6—8 inches as equivalent to a standard, whilst butts of 15—18 inches are considered equivalent to 1½, and larger butts to 2 standards. A similar custom prevails in Norway where a standard contains about 2½ tons of timber.*

It is clear that such a method greatly facilitates trading, for the price of each class is a multiple or part of that of the standard log and rises and falls with it. At the same time it is much simpler to calculate prices by the cubic contents, than where a few millimeters in the diameter of the butt give rise to a considerable difference in prices. Besides, it is evident that traders must have experience in the method before they can understand all its refinements thoroughly, and this gives local traders a considerable advantage over would-be competitors from a distance. This naturally reduces competition and prices. Hence the method is falling into disrepute, and will probably be replaced gradually by that which employs the cubic contents.

(b) **Piled Lots.**—With the understanding that poles and other small classes have been duly placed in lots, all that has to be done here is to count the numbers of lots of each class and enter them in the book. They are reckoned also in cubic meters.

When for instance the forest-manager enters half a hundred second-class hop-poles in his book, their volume is known, for from the class-tariff the dimensions of a second-class hop-pole are known and therefore how many such hop-poles go to a cubic meter.

The cubic contents of poles is measured in the same way as for logs, but evidently this need be done only in a few cases

* [In the timber-trade, standards usually represent planks, thus the London standard is 120 × 12 ft. 3 in. × 9 in. deals.—Tr.]

to determine the average, or experimental tables may be referred to for the purpose. It is to be regretted that there is little general agreement as to the class dimensions of poles, and the volumes of different lots are in a state of chaos.

(c) **Stacked Wood.**—In estimating the quantity of stacked wood and faggots, all that has to be done is to count the number of units of recognised dimensions and enter them in the book, and as the stacks are usually 1, 2, 3 or rarely 4 stacked cubic meters, this is a very simple affair. At the same time, the dimensions of the stacks as to height and breadth should be checked, here and there, by actual measurement. The depth is the actual length of the billets, the correctness of which should be seen to carefully during the conversion. The stacks must be piled also as densely as possible; badly piled stacks should be upset and piled again. The length and girth of the faggots should be checked at the same time, and the number of faggots entered in the book.

3. *Estimating the Quality of the Produce.*

This includes all the points already referred to, such as species, grain, and customs of the market. The species should be entered always in the range receipt-book, but to enter the other points would lead the manager too far into detail. Taken altogether, however, they enable the forest manager to decide on the quality of the produce and he will pay the more attention to these points, the more valuable each lot is likely to be.

As already stated, the greatest attention should be paid to the quality of the oak-timber and to logs of spruce and silver-fir, which have far to go to reach their ultimate destination. In the interests of trade, it is desirable that such wood should be perfectly sound at least when handed over by the forester to the timber-merchant.

4. *Valuation.*

As soon as the quantity of the produce of the felling has all been entered, and the manager has become acquainted with the quality of each lot, he should proceed to put an estimated price on the lots, in accordance with the latest information he

has acquired regarding local demands. The sale-price which the produce will realise often depends greatly on the fact that a proper valuation of it has been made before the sale by the forest-manager.

In order to arrive at such a result, he must be acquainted thoroughly with the actual state of the market, and with the technical qualities and defects of his wood, and the purposes for which it is likely to be employed.

The manager should bestow the greater care on the classification of his produce, the more valuable it is, and when full-sized logs of good timber are included, a rough estimate of their value will not suffice. In such cases, the entire log should be valued in length sections in accordance with the uses to which it may be put. As each piece or lot is valued, it should be stamped with the range-hammer, generally close to the number it already bears. This denotes that the wood has been entered in the range receipt-book and is useful in the control of the transport or in possible cases of speculation.

SECTION X.—CONCLUDING THE BUSINESS OF FELLING AND CONVERSION.

As soon as the range receipt-book has been written-up, the produce of the felling must be tabulated to show its value, then the depot should be inspected, the workmen paid, and thus the whole business concluded.

1. *Registry of the Amount and Value of the Yield from the Felling.*

The results of the felling, as shown in serial numbers in the range receipt-books, must be entered in the felling-register, which summarises the total amount of produce of each class of material and its value. The prices of the units of each class of produce should be average local prices, and generally are kept up to date separately for each range and sometimes termed *timber-royalties* (*Holztaxen*).

At the same time, the produce may be marked for sale in lots which as already stated should be larger or smaller, according to the circumstances of the market (*Vide*, p. 242).

As these prices, or royalties, are fixed by units—at so much a cubic meter or cubic foot, per log, per hundred poles, etc., per stacked cubic meter, 100 stacked cubic feet, cord or 100 faggots—all that has to be done is to multiply the number of units in each class by the price of a unit.

The felling-register usually contains a summary of the whole produce of the felling, and for this the cubic meter is used generally throughout Germany, France, Austria-Hungary and Switzerland.

There is no difficulty in calculating the cubic contents of all the timber and poles, and certain reducing factors established by experiment are used to transform all the stacked volume of the firewood, faggots, etc., from stacked to solid measure.

The following average reducing-factors were determined by measurements made in Austria, for pieces one meter long:—

| | Hardwood. | Softwood. |
|------------------------------------|-----------|-----------|
| Stacked timber | ·73 | ·77 |
| Split firewood 1st class | ·67 | ·68 |
| „ 2nd class | ·63 | ·65 |
| „ 3rd class (knotty wood) | ·58 | — |
| Round billets | ·57 | ·64 |
| Ditto small | ·44 | ·50 |
| Root and stump-wood | ·40 | ·47 |
| 100 Faggots | 1·61 | 1·65 |

Beech, [ash, sycamore.—Tr.] hornbeam and oak are classed as hardwoods; alder, birch, aspen, spruce, silver-fir, larch, Scots and Austrian pines as softwoods.

2. *Revision of the Record.*

On completion of the felling-register, or before it is written up from the range timber receipt-book, the record of the produce of a felling may be revised by a superior forest official. This should be done carefully in the case of valuable timber, but is hardly necessary for firewood.

3. *Payment of the Woodcutters.*

As soon as the full statement of the produce from the felling-area has been prepared, there can be no difficulty in settling

accounts with the woodcutters; for by multiplying the contracted rates of pay per unit of produce by the quantity of material, the total amount due to them is easily calculated. Owing, however, to the generally impecunious condition of the men, it is usual from time to time to pay them advances in respect of work done; generally these are made every fortnight, or weekly. The sums paid should be proportional to the work done by the men, that always can be calculated roughly. In order to prevent the risk of over-payment and keep the men at the work, about one quarter of their earnings is kept back till the whole work is done; then the balance is paid to the men after deducting all their advances from the total amount due for the work.

It is generally the duty of the foreman to draw the payment from the forest cashier, and distribute it among the different parties of woodcutters. Wherever the work has been given to a contractor, he will be paid for it in full.

To attempt to pay ready money for the whole work during its progress, as portions of the wood are felled, converted and placed in the depot, is only to introduce complications and unnecessary trouble into the business.

CHAPTER III.

WOOD TRANSPORT BY LAND.

INTRODUCTION.

THE largest forest areas are found generally in thinly-populated remote districts, and the forest-owner must, therefore, in such cases, expect only a limited demand for the produce of his forests unless he can improve the means of communication between them and distant markets. The forest-owner often undertakes the transport of his own wood, sometimes directly to the timber-market, or to a place where existing means of communication are good enough for no further trouble in this respect on his part to be necessary. If, however, the transport of the timber is undertaken by agency independent of the forest-owner, the latter should endeavour to improve the means of communication between his forests and the markets, so that wood may be conveyed as cheaply as possible.

The great improvement during the present century in communications, and especially by means of railroads, tends more and more to reduce the cost of carriage, which is a vital question in forestry. It is therefore necessary to connect the forests with the general lines of land and water communication, in order to get full value for forest produce, and especially for the better classes of timber. Although the forest-owner has to face greater difficulties in this respect than any other large producer, yet recently nowhere has greater energy been shown than in improving forest communications.

Wood-transport, therefore, means the conveyance of the wood to the more or less remote markets or depots by means of more or less permanent routes. Transport is thus distinguished, by the greater distance over which it acts and the more permanent nature of the routes employed, from **clearance of the felling-area**, although both these measures

frequently coalesce, and cannot be sharply distinguished from one another.

The transport of wood is distinguished as **transport by land** and **transport by water**, a short account of each of which will be given; the values of the different methods described will then be compared, and permanent timber-depots will be described. In the present book, full details as regards the construction of the different means of communication will not be given, and they will be described only in a general way.

This chapter deals in detail with land-transport only, the different means of land-transport for forest produce being **forest-roads, timber-slides, forest-tramways and wire-tramways.**

SECTION I.—FOREST-ROADS.*

A. CONSTRUCTION AND MAINTENANCE.

(a) **General Account.**—Forest-roads are undoubtedly the best means of land-transport for forest material, and good forest management must attend strictly to the necessity for intersecting forests with good roads. The chief reason for the preference of roads to other modes of timber-transport depends on their superior durability.

Forest-roads are constructed not only in plains, hills and low mountainous districts, but even in high mountain-ranges, and are being extended constantly to the less accessible forests at high altitudes.

(b) **Network of Roads for a Forest.**—In constructing forest-roads it is absolutely necessary to proceed according to a well-considered plan, forming a network of roads throughout a forest range or a separate forest. The planning of this road-network should contemplate not only present demands but also those of the future, and thus consider parts of the forest which will be worked at some future time.

The road-network therefore should be projected and planned for the whole forest, though it may be necessary at present

* Cf. "Waldwegbau" by C. Schuberg, Berlin, 1873, also by Stötzer, 3rd ed., 1895. Wimmenauer, 1896. Dotzel, 1898. Marchet, 1898. C. G. Rogers, "Forest Engineering in India," Calcutta, 1900, 3 vols. Mathey, *op. cit.*

to construct only certain parts of it. The other parts of the network will be constructed, *seriatim*, as the working of the forest proceeds, and by the end of a forest rotation, the whole projected network will be completed. It is, however, indispensable to take in hand the roads for certain forest compartments several years before the regular course of fellings reaches them, so that they may be ready in time. It is especially necessary in mountain-forests, where road-making is most difficult and expensive, that the plan for the network of roads should be thoroughly well devised. In the case of forests in plains, it may be permissible to construct temporary roads, which are allowed to fall into disrepair when all the material for which they were constructed has been transported. This is not sufficient for mountain-forests, where all roads made should be kept in constant repair.

The **main roads** should run through the heart of the forests, and be so directed that they lead to other public roads in direct communication with timber-markets, or to railroads or streams serving for water-transport. The forest-roads are themselves often public roadways. **Subsidiary roads** branch-off from the main roads into the forest, and may serve as means of transport from all parts of it. In tracing subsidiary roads, the forester always must keep in view the fact that each of them should serve several compartments of the forest, and therefore should cut right through the felling-areas or adjoin them, or be connected with them by smaller bifurcations.

The principal forest-road usually follows a valley leading towards the timber-market; it either reaches this valley within the limits of the forest, or keeping more to the high and less broken ground descends to it outside the forest. The main roads should be arranged so as to connect the market with all parts of the forest, by means of the subsidiary roads, without its being necessary for the latter to make any long ascent to reach them.

In level and slightly undulating ground, every forest boundary-line and every forest-ride may serve as a subsidiary road. In mountainous forests, however, the roads, descending in long curves from the heights to the chief line of communication below, pass repeatedly through the compartments;

or roads at different altitudes are connected by means of slides, which are often necessary where the mountain-slopes are steep. The subsidiary roads may be traced also along the narrow side-valleys of the higher mountain-ridges, into which the wood is brought from both sides. In such cases the roads must wind round every intervening spur or rock in order to communicate with the felling-areas.

In the case of an extensive tract of woodland belonging to one owner there is little difficulty in laying out a network of roads, but where the properties are subdivided among several owners, or where the forest surrounds other property, there are often serious obstacles to be dealt with. Old roads which one is loath to abandon are often sources of difficulty. It may also be the outlets from the forest where difficulties arise, when the fields beyond it that should be traversed by well-constructed forest-roads belong to poor or obstinate village communities, or to private owners.

As regards the kinds of road to be constructed, a distinction may be made between earth-roads, paved-roads or *chaussées*, and roads chiefly made of wood.

(c) **Earth-roads.**—In earth-roads no material is used but that found in the immediate neighbourhood of the road. In the plains the road is lined-out, roots of trees extracted and removed, ditches dug to serve as road-boundaries and for drainage, and the material from the ditches placed on the surface of the road to give it the requisite curvature.

In mountainous forests a horizontal basis must first be given to the road by excavating the slope above its axis and throwing the material below it. Wherever the slopes are very steep, retaining-walls of either stone or wood must be constructed below the road; in such cases the stones necessary for this purpose are nearly always available alongside the road, and with them dry masonry retaining-walls may be constructed; only exceptionally should wood, which is so perishable, be used for this purpose.

Earth-roads may be improved considerably if they pass over clay or limestone, by strewing the cart-track with small broken stones, sand or gravel, or by putting on a layer of clay if the soil is too loose. Whenever roads are much used this

must be done if they are to be at all permanent. If, instead of merely spreading stones on the surface, the cart-track is covered to a depth of 8 to 12 inches with broken stones which are well rammed down, the road is said to be **macadamised**.

In constructing forest-roads the greatest attention must be paid to drainage, and this is of the highest importance in plains and on peaty soil. In hill-roads, drainage is generally secured by their sloping nature, especially on sunny aspects. In order to drain roads on north and east aspects and on level ground, side-drains must be kept open and the surface of the road suitably curved. The road also must be raised above the ordinary ground-level and well aerated by keeping it free from over-hanging trees [although it is well-known that road-side avenues are highly efficient drainers when the trees are not too near the cart-track and are properly pruned—Tr.]. Where sufficient fall cannot be given to the side-drains, and stone is not available, as in depressions on the plains, in alder-woods, etc., every means should be taken for raising the level of the road, and the ditches kept at some distance from it so that the water in them may not permeate into the road and make it soft. The draught of air is increased by keeping the road straight, clearing broad road-sidings through the forest and cutting away all overhanging trees.

Macadamised roads have the great advantage over paved roads, especially when gravel and small stones are at hand, of being not only cheaper but actually easier for traffic than the latter, except when very carefully constructed.

(d) **Paved Roads.**—Paved roads are distinguished from ordinary roads by their greater width and the greater attention paid to the gradient, but especially by the care with which they are metalled. The cart-track in them is excavated, lined with stones or cement, and coarse broken stones are then spread on the surface and rolled down firmly. Several other layers of stones are then superposed, each layer consisting of finer material than the one below it. It is always better to use broken stone, which packs better than round pebbles. Each separate layer is rolled and firmly pressed down. The more gradual the change of size in the material used for successive layers of metalling, the more durable the

roadway will be. If small stones are placed directly on a coarse basis, the road soon becomes worse than the simplest macadamised road; the coarse stones from below work their way through to the surface, rendering it uneven, and forming holes into which material placed to mend the road soon sinks. As these paved roads everywhere must be constructed strongly, the retaining walls, culverts, bridges, etc., are much more elaborate than on ordinary roads; frequently solid masonry-revetments are applied to the steep slopes above them in order to prevent landslips, and in any case, slopes of soft material must be terraced and wattled.

The main roads coming from a forest, where the traffic is continuous, should be constructed as paved roads or at least macadamised. Even the most frequented subsidiary roads should be macadamised. False economy is never more out of place than in the construction of indispensable forest-roads. [Even mule-tracks four to six feet wide, in the Himalayas, should be macadamised.—Tr.]

(e) **Roads made of Wood.**—Such roads are not durable and should be avoided as much as possible. On peaty soil and in swampy depressions, however, they cannot be dispensed with, nor for summer-sledging. They are of three kinds: roads made of fascines, of round pieces of wood and sledge-roads.

i. *Roads made with Fascines.*

Fascines are used for short distances in crossing swampy ground, which cannot be drained easily, especially over peat-mosses where macadam would sink in uselessly. After digging the boundary ditches of such roads, a layer about one foot deep of birch, spruce or Scots-pine branches is placed evenly on the track, the larger ends being turned inwards; on this is laid a layer of moss, heather, bilberry or turf-sods, etc., whichever the locality affords, and the surface is completed with gravel, iron-pan or clay. Sand alone should not be used, as it soon finds its way through the substructure of the road, and in any case is a bad binding material; sand, however, when mixed with clay or loam, may be used to cover the roadway.

Where roads cross shifting sands they may be constructed similarly.

ii. *Corduroy-roads.*

These are made under similar circumstances to the fascine roads for crossing short stretches of swampy ground. In this case, the lowest layer consists of middle-sized logs placed close together longitudinally in the direction of the road, and upon them round or split billets of wood are packed transversely, whilst poles are pegged down firmly on both sides along the edges of the roadway above the billets to retain them in position.

This kind of road is used to prevent the feet of beasts of draught from sinking into swamps, and is also much used for filling hollows in the construction of sledge-roads.

iii. *Sledge-roads*

Permanent sledge-roads are used in the summer transport of wood over slightly sloping ground. In order to reduce friction in sledging logs or fire-wood, the road is laid transversely with middle-sized round billets which are held in position by pegs driven into the ground. Their distance apart should not exceed two feet, so that the sledges may rest always on at least two of them. To reduce friction further, the billets are often smeared with grease, or water is poured on them. In the case of their being too slippery after rain, sand may be strewn on them to increase the friction.

In the Barr forest-range in Alsace, sledge-roads are extensively used, also in most of the forests of the Vosges mountains.

[A much more elaborate sledge-road than those described here was made in the forest of Tihri Garhwal, in the north-west Himalayas.* Its gradient varied between 5 and 11 degrees, and experience shows that 8 degrees is best, and the sharpest curve has a radius of 20 feet. The length of this sledge-road is 5877 feet, and the total fall 835 feet. It was

* For a complete account of this sledge-road, see "Indian Forester," Vol. XII., p. 366.

constructed of defective meter-gauge deodar railway-sleepers which measure 8 feet \times 8 inches \times $4\frac{1}{2}$ inches, two sets running horizontally and $2\frac{3}{4}$ feet apart, being jointed and pegged together by oak pegs, whilst the transverse sleepers were pegged into them at distances of $2\frac{1}{2}$ feet. The grooves in which the sledges run varied in breadth from 4—6 inches according to the curves, and were $\frac{1}{2}$ to $\frac{3}{4}$ inch deep, and 2 feet apart. The central part of the roadway was ballasted up to the level of the transverse sleepers to prevent the roadway from shifting, and to serve as a footpath. Guards consisting of half-sleepers were placed on the outside of all sharp curves to prevent the sledges leaving the road.

The roadway itself in many places was blasted out of precipitous rock and contained 20 bridges and wooden viaducts, altogether 1068 feet long. This sledge-road proved very economical in the transport of railway-sleepers. In the adjoining Bamsu sledge-road, the line on the steep gradients was made of pine, the cross-pieces being 3 feet apart to increase friction, and sand used freely. On low gradients finely grained, hard timber, such as Sissoo, was used, and the cross-pieces, 2 feet apart. On intermediate gradients, deodar.—Tr.]

(f) **Horizontal Plan of Roads.**—As regards the horizontal plan of forest roads, sharp curves with a radius less than 100 feet should be avoided as much as possible, especially in mountain districts, and the roads should run in long sweeping curves. . Wherever the transport is mainly concerned with logs, attention should be paid to the possibility of the road being used for sliding the timber or for a forest tramway.

(g) **Gradient.**—It is most important to decide on the gradient of a forest-road, which should be constructed only after pegging out the levels. Roads for general traffic have a maximum gradient of 5 per cent., which is also a desideratum for main forest roads, as in such a case, the road may be conveniently traversed in both directions. Forest-roads, however, are generally used uphill by empty conveyances, and those which are laden generally come downhill, so that gradients in main roads may go up to 7 and 8 per cent., and in subsidiary roads to 10 per cent., and even more according to the manner in which they are used.

Steep gradients should be avoided always for cart-traffic, not only to facilitate the latter, but also to protect the road, which when steep is liable to much injury from the use of the brake and owing to erosion by water. **Sledge-roads**, on the contrary, require a steep gradient and have been constructed recently in a most perfect form in high mountain-regions, being made of two kinds for sledges drawn by men or animals; they may be termed **feeders** and **main sledge-roads**. The latter are confined to the lower ground; traverse long valleys, and serve for conveyance of the wood to depots. The feeders descend the mountain-slopes from the highest and most inaccessible parts of the forest, they often wind round all kinds of obstacles, rocks are blasted to make way for them, galleries cut along precipices and tunnels bored. By their means the wood is brought down to the main sledge-roads. Wherever sledge-roads run through cuttings in districts with heavy snowfall, they must be covered with rafters and spruce branches for protection. The gradient of the feeders should not be less than 6 to 8 per cent., or greater than 18 to 20 per cent., though even the latter is sometimes exceeded, but 12 to 15 per cent. are the usual gradients. The main sledge-roads are less steep, and 8 to 12 per cent. are usual gradients, but even a slight ascent cannot always be avoided in their case where a ridge has to be crossed between two valleys.

Ground timber-slides are used extensively in the eastern Schwarzwald; they may be used also as sledge-roads chiefly for the transport of logs. Their gradient should lie generally between 9 to 12 per cent., and may go up even to 18 per cent.

A steady gradient is more necessary in the case of sledge-roads than on roads for wheeled traffic; in the latter case, now-a-days it is considered better to vary the gradient, as this is less tiring to beasts of draught than a uniform gradient which always calls on the same muscles.

(h) **Breadth of Roads.**—The breadth of forest-roads depends on the mode of conveyance used, and the amount of traffic. Main forest-roads should not be less than 18 to 24 feet broad, if the traffic on them is not to be impeded, 6½ to 8 feet being the width between the wheels of a cart.

The subsidiary roads need not have a greater breadth than

10 to 15 feet. The breadth of sledge-roads is still less, for the main sledge-roads 8 to 10 feet, and for the feeders 8 to 4½ feet. Road-slides may be 6 to 8 feet wide. All roads, however, which are wide enough only for one cart or sledge, must have sufficiently wide places here and there for the return traffic to pass; wherever logs are transported, the breadth of the road must be increased at all turnings, or where curves run round projecting rocks. Otherwise logs must be fastened along the edge of the road on which the projecting ends of logs dragged on small sledges may slide.

In the case of narrow sledge-roads with steep gradients passing with curves over precipitous ground, accidents are avoided by placing logs along the edge of the road, that touch one another at their ends and are kept in place by piles or props.

(i) **Maintenance of Roads.**—Wherever there is heavy traffic, roads suffer much damage, by the use of brakes, etc.; in mountains the rain-water brings down silt and landslips, and may inundate the roads at certain points, so that their surface is constantly being degraded. Continual prompt maintenance and repairs, improvements of the drainage of the road and filling-up all holes and ruts are therefore necessary. Repairs to roads, therefore, require almost as much attention as their construction. The chief rule is not to allow any damage to get the upper hand, but to commence repairing it as soon as the weather is dry. It is often advantageous to entrust the repairs of the roads on contract to trustworthy woodcutters [or to apprentice forest-guards, as in France (*gardes cantonniers*), who work themselves and also supervise the other labourers.—Tr.].

In many forests it is customary to place a bar across roads after the season's transport is over, in order to protect them from extraneous traffic. The possibility of doing this depends on the nature of the forest-rights and other local circumstances. As a rule, such a practice does more harm than good to the forest. Roads should be open to traffic, and the more they are used and injured by the traffic, the more useful they are, and the higher the net-revenue of the forest will be.

B. MODE OF CONVEYANCE.

The conveyance of the converted wood along roads to the collecting or sale depots is effected either by **men** or **beasts**.

(a) Conveyance by Men.

Conveyance by men is confined almost entirely to sledging, which in **transport**, as opposed to **clearance of the felling-area**, takes place on permanent sledge-roads. Only firewood and scantling or butts, but not long logs, may be thus transported. In the case of sledges, it is impossible to draw any sharp distinction between transport and clearance, except that in high mountain-regions sledging bears more of the character of transport, and in lower hills, of clearance. From both points of view the methods of sledging have been described already (p. 272).

In forests of low hills and plains, no permanent sledge-roads exist, and sledges are used only to convey the wood to the nearest cart-road. In mountainous regions, however, there is no object in removing the wood merely from the felling-area to the nearest road. It is a question of transporting it for miles over permanent sledge-roads down to the valleys to depots, or rafting-stations, at low altitudes; this implies a separate industry not always intimately connected with the felling operations.

i. *Winter Sledging.*

In most cases sledging is done over the snow, and the same kinds of sledges are used as in clearance of the felling-area (*vide* p. 271). Sledges used for firewood have high side-pieces, but for those used for carrying butts, the loads are fastened by means of chains and ropes, and the sledges are longer, as shown in Fig. 186, which represents a Bavarian timber-sledge. Before sledging begins, the wood is frequently piled-up in stacks, but usually the sledge is laden on the felling-area and brought down to the depot. Wherever sledging is done independently of the felling operations, and by many workmen acting together, a certain order and uniformity in the operations will be found very effective. Therefore, and in order to avoid

the constant interruptions to the work, which sledges ascending and descending simultaneously would cause, a large number of sledges are laden, and descend and ascend together

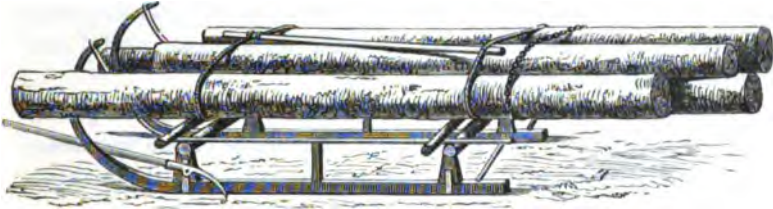

Fig. 186.—Bavarian timber-sledge.

(Fig. 187). Sometimes the returning empty sledges are carried back along the sledge-road, but the workmen usually prefer to carry them by the shortest cut, uphill. At the collecting

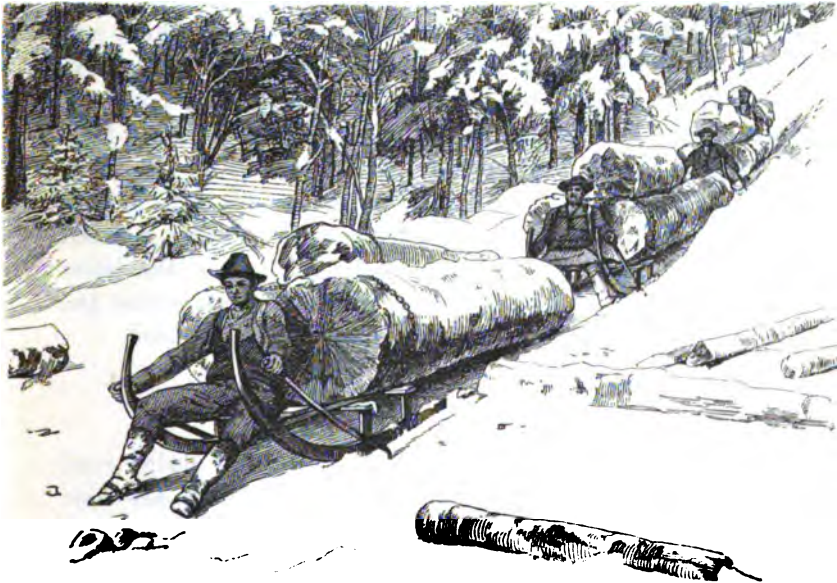

Fig. 187.—Timber-sledging.

depot the wood must be stacked carefully in order to economise space; or if further transport is down slides or by water, it may be thrown at once down the slide or into the water.

In many mountainous districts, as in the Alps and Vosges, sledging is the usual mode of conveyance of wood; the work is commenced at the first fall of snow and continued as long as the weather permits. Huts built of wood or stone are provided in suitable places for the workmen, so that they may remain constantly at the work; these huts prove useful also during felling operations.

The loads which may be transported by a sledge vary with the size of the sledge, the skill and experience of the workmen, the gradient, the nature of the sledge road, and the distance of the collecting depot from the felling-area.

Much greater loads can be carried down regular sledge-roads than on mere hillside tracks. The load may be $1\frac{1}{2}$ to 2 stacked cubic meters, *i.e.*, 50 to 70 stacked cubic feet. This, however, implies that the sledge-road is in good order and to secure this the workmen have often to work several hours daily. The amount of wood a man can bring down in a day depends firstly on the distance traversed, and then on the condition and gradient of the sledge-road. With moderate and uniform slopes and a good road, a man can bring down 3 to 5 stacked cubic meters (100 to 175 stacked cubic feet) of firewood for a distance of about 3 kilometers, say 2 miles; or 10 to 12 stacked cubic meters (350 to 420 stacked cubic feet) to half that distance. The amount of work done is, however, reduced where the gradient is very slight or excessive, as in the latter case the return of the sledge is difficult; also, where the gradients vary so that brakes have frequently to be used.

ii. *Summer Sledging.*

Sledging during summer takes place on the sledge road described on p. 306, and both firewood and butts are thus transported.

In the forest of Barr, in Alsace, there are 24 kilometers of summer sledge-roads, the longest being 7 kilometers. These roads cost 43 pf. per meter (*5d.* a yard), and the round billets of silver-fir and beech last ten years. The cost of the transport of fuel is 70 pf. per stacked cubic meter (*2s.* per 100 cubic feet); 2 to 5 stacked cubic meters (70 to 175 stacked cubic feet) of

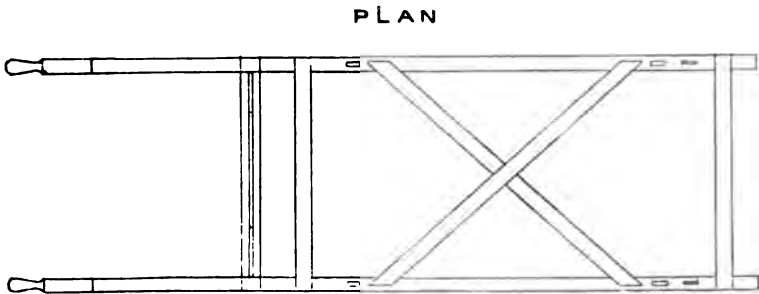
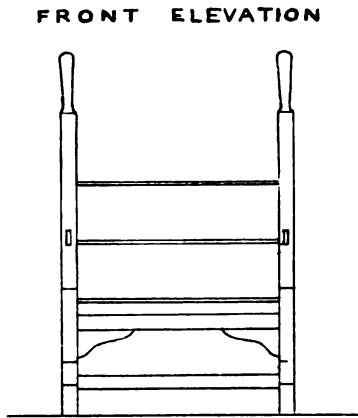
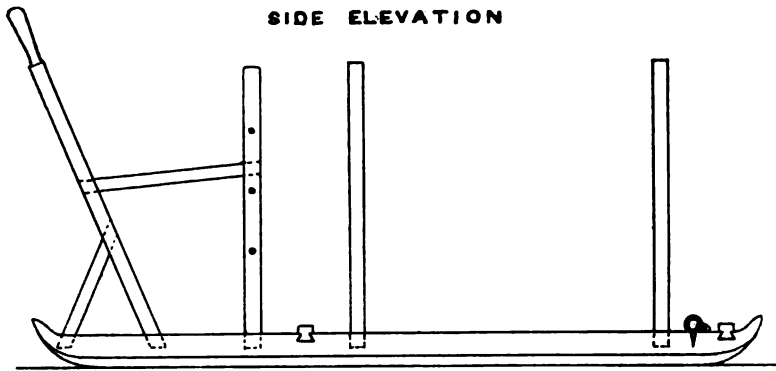

PLATE III.
HIMALAYAN SLEDGE FOR RAILWAY SLEEPERS.

[To face p. 313.]

firewood form the load, or from 3 to 6 butts, according to the gradient.

[In the Himalayan sledge-road referred to on p. 306, two men carry down daily 100—120 meter-gauge sleepers ($6\frac{1}{2}$ ft. \times $8\frac{1}{2}$ \times $4\frac{3}{4}$ inches), whilst they could carry down only 24 on their shoulders, the distance being 1 mile and 1 furlong. Twenty-five meter gauge or 15 broad gauge sleepers go to a load, the weight being about 1 ton. Plate III. shows the nature of the sledges used ; they are 3 feet wide.—Tr.]

(b) Transport by Beasts.

Transport by the help of beasts is carried on with carts and sledges, and less frequently by dragging or by pack animals.

i. *Ordinary Cart Traffic.*

On a dry roadway the ordinary four-wheeled timber-cart is used, and for firewood it must have sides, but for poles and middle-sized logs, these are not required. The wood is secured to the cart by means of ropes and chains ; and specially strong carts are used for large logs and butts.

The mode of transport by carts depends chiefly on the quality of the roads, as obviously larger carts may be used on good roads than on bad ones. The largest waggons for firewood are used in the Schwarzwald, and often carry 30 to 36 stacked cubic meters of wood (14 to 17 tons).

In carrying long logs, the front and back parts of the timber-cart are separated and the butt-ends of the logs are placed in front, their smaller ends being suspended under the axle of the hinder pair of wheels, so as to allow for turning at curves in the road. All timber-carts should contain levers, a screw-jack and the necessary chains. If the wheels are high enough, the log is sometimes hung under both axles, which saves the frequently laborious process of loading the timber ; and if, in such cases, in descending steep slopes, one end of the logs drag along the ground, it then acts as a brake.

Generally horses are employed in timber transport, although bullocks are very serviceable and replace them in certain districts on the Continent and in hot countries.



Fig. 188.—Horse-sledge with removable frame.



Fig. 190.—Brake.



Fig. 189.—Short timber-sledge with brakes.

ii. *Sledging with Beasts,*

After a fall of snow, sledges laden with firewood may be dragged conveniently by a horse or bullock; they are larger than the ordinary sledge, and have short horns and two shafts. For the transport of butts, short sledges are used. In many Alpine districts, horse-sledges are provided with a moveable frame (Fig. 188). In transporting butts the latter are fixed at their upper ends to the short sledge (Fig. 189) by chains and nails, their lower ends sliding on the ground. If the gradient be steep another butt is dragged behind the sledge. The brake consists either of a bundle of firewood attached

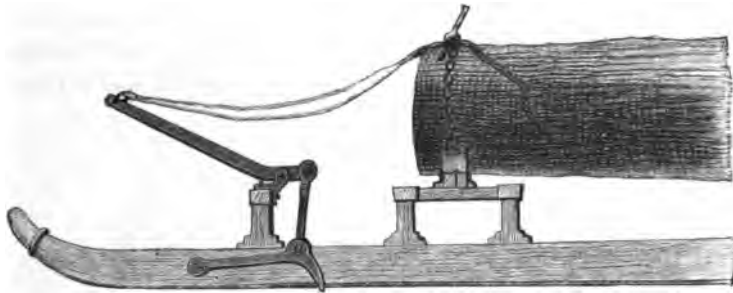

Fig. 191.—Wasenmeister's brake.

to a short chain, or a piece of planking, on which the driver stands. It may be the brake shown in Fig. 190, on which also the driver stands. The construction of Wasenmeister's brake is seen from Fig. 191.

Sledging by the help of horses is followed extensively in the Bavarian Alps, where the brakes just described are all in use.

iii. *Dragging by Beasts.*

Dragging logs by beasts is often impracticable on ordinary roads, on account of the great damage which would ensue.

iv. *Use of Pack-cattle.*

In Germany the use of pack-cattle, mules, or ponies for the transport of firewood or charcoal-wood, is limited to the Alps,

where the wood which has been collected lies scattered over a large area. A horse carries only 2 cwt., while it can drag 7 to

9 cwt. At the same time, pack-animals require only bridle-paths, which can be constructed and kept in repair much more easily and cheaply than cart-roads.



Fig. 192.—Carriage of boxwood by mules.

[In the Himalayas the transport of firewood is carried on extensively by means of pack-mules and ponies, in billets 3 feet long, and the cost of conveyance is 1 rupee 6 annas per 100 stacked cubic feet per mile for oakwood, and 1 rupee 2 annas for fir (Fig. 192).—Tr.]

SECTION II.—TIMBER-SLIDES.

A. CONSTRUCTION.

A timber-slide is a more or less permanent channel, either constructed of wood or excavated in the ground, and placed along a mountain slope; the wood descends by its own weight. Slides may be distinguished as **wooden slides**, **ground slides**, or **roads used for sliding timber**.

1. *Wooden Slides.*

Wooden slides may be constructed either of butts or poles, or of planks.

(a) **Log or Pole Slides.**—These are semi-circular channels, made of closely-packed poles, or logs, 4 to 12 inches thick, and are used for timber transport. The pieces of timber used in constructing ordinary slides of this kind should be 16 to 26 feet long, and the separate sections of which the slide is made are the same length as the pieces. The length of a slide is thus frequently described by the number of sections it contains. The channel has a width of $2\frac{1}{2}$ to 5 feet; it rests

on strong wooden supports, which may be termed **block-sleepers**, and are made of different shapes. Owing to the great weight of the slide that naturally tends to drag it down-hill, this tendency being increased by the shaking to which it is subject whilst sliding is in progress, the block-sleepers must be supported by props on both sides to keep them steady. Only when the block-sleepers are sufficiently massive to preserve their own stability can these props be dispensed with. The lowest section of a slide is made very strong to resist shocks, and is either horizontal or inclined upwards, in order to moderate the fall of the wood as it slides down. It should rest on strong blocks of wood driven into

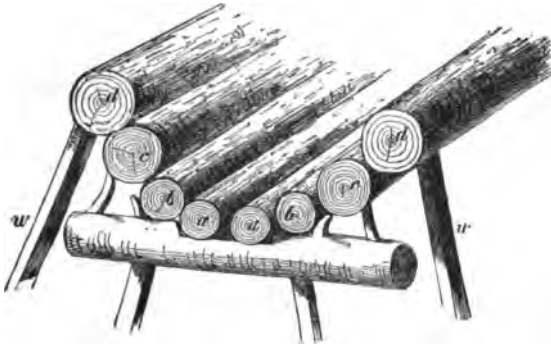

Fig. 193.—Timber-slide.

the ground, and the effect is to shoot the descending piece of wood upwards in a curve, so that it may fall without any great shock (Fig. 196).

As a rule (Fig. 193), each section consists of six poles, two (*a a*) forming its base, two (*b b*) the sides, and two (*c c*) the edges of the slide. In curves, one of the pieces *c* may be omitted on the inner side. Where the gradients are very steep a second pair of poles (*d d*) may be added. The pieces of wood on the inside of the slide are all barked.

The sections of the slide are joined together as shown in Fig. 194. The pieces *a a* fit into the groove of the block-sleeper (Fig. 195), the pieces *b b* rest between the former and pegs driven into the block-sleeper, and *c c* on these pegs and two others similarly fixed; they are kept

in place by props (*w*); *d d*, when used, are similarly supported.

The construction of slides in the Black Forest is somewhat different, as shown in Fig. 196, where all the poles, except the two lowest, are bored by augers, and kept in position by strong beech trenails. In some cases a plank is used for the bottom of the slide.

The trestles supporting the block-sleepers vary in height, according to the nature of the ground, or the block-sleepers may rest directly on the ground.

In the Black Forest and the Tyrol, the block-sleepers rest usually on round billets.

Fig. 197 shows the mode of construction of the end-section



Fig. 194.—Method of joining pieces of a slide.



Fig. 195.—Block-sleeper.

of a slide, *m* being a plate of wrought iron, over which the descending pieces slide, and which, owing to its elasticity, propels them upwards before they fall.

Slides intended for the transport of logs must be constructed in a much stronger manner than those for firewood, and it is then chiefly the side-pieces (*b* and *c*) which must be strongly supported; logs measuring one foot and one foot two inches in diameter and 50 to 60 feet long may be used.

The slide shown in Fig. 198 is used for logs in the Driften-thal, in N. Tyrol. It is sub-divided above into two branches, and is chiefly used for bringing down butts; its strength of construction may be judged from the plate.

When sliding logs 30 to 60 feet long, it must be remembered that where the slide is of any considerable length the

logs shoot out from it with great velocity, and to considerable distances, which may extend to 200 or 300 feet in the gently

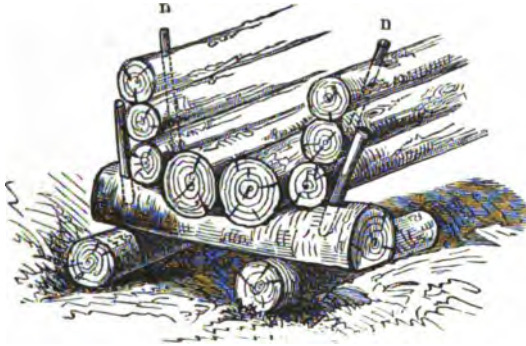

Fig. 196.—Black Forest slide.

inclined foreground of the slide (in the Salzkammergut and other places).

Arrangements sometimes have to be made to reduce the

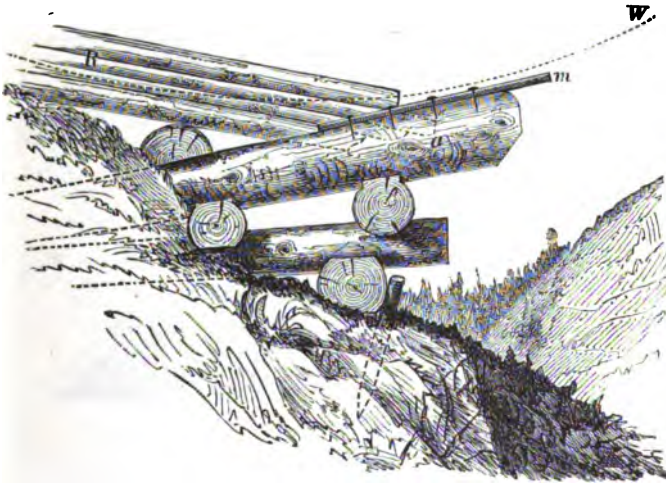

Fig. 197.—Lower extremity of a slide.

velocity of logs when sliding, and a mode of brake for the purpose is shown in Fig. 199; as the log coming down strikes and lifts the brake, its velocity is reduced. Another plan is to lead an intermediate section of the slide upwards,

and allow the piece to fall into a side-bifurcation by which the slide is continued. The piece of wood loses all its acquired

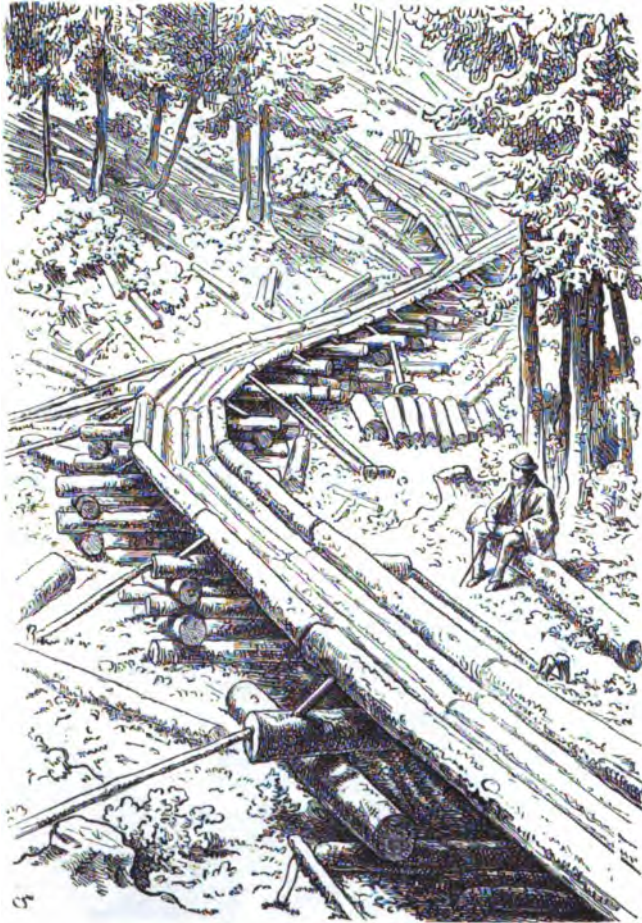

Fig. 198.—Slide in N. Tyrol.

velocity in this change of direction and then descends again, until it meets with another brake.

[The largest slide of this nature hitherto made in India is the Bakani slide, near Chamba, in the Punjab. It is 12,539 feet long, with a vertical fall of 1,650 feet, or an average gradient of $13\frac{1}{3}$ per cent. It is formed of 4,000 deodar-logs of



PLATE IV.

BAKANI TIMBER SLIDE IN THE CHAMBA FORESTS.

[To face p. 320.



various sizes, of which there are 4—6 in a cross-section, and generally they are embedded in boulder ballast; when the present working of the forest-block has been completed these logs will be removed and exported as timber. Where the line is above the ground-level, the slide is supported on piles made as follows :—

Two logs, about 8 feet long, are placed 10 feet apart in line with the slide, cross-wise on these are placed two others 12 feet long, notches in their ends fitting into corresponding notches in the others, then two more longitudinally and so on,

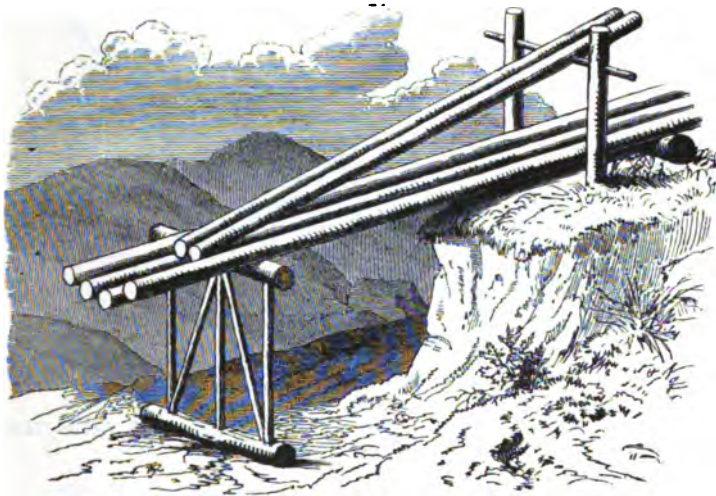

Fig. 199.

till the required height is reached. The middle space is filled with boulders, and the outer frame-work is packed with dry stone-masonry to give solidity to the piles.

The largest log sent down was 48 feet long and it descended for 2,500 feet, at the rate of 20 miles an hour. *Vide* Plate III.—Tr.]

(b) **Plank-Slides.**—In plank-slides, as shown in Fig. 200, the base and walls are made of planks, which are let into the block-sleepers and nailed firmly to them.

[In the Lambatatch Forest in Tihri-Garhwal in the north-west Himalayas, a slide of this kind, $2\frac{1}{2}$ miles long, was made by

simply wedging together two vertical and one horizontal planks, each measuring 13 feet \times 12 inches \times 5 inches, into block-sleepers. It was used for broad-gauge railway-sleepers, which fell into a deep part of the river Tons. This slide was 1 mile 1,052 feet long and the fall 2,687 feet, the average gradient being 2 in 9 or 22 per cent. Brakes formed of 2 and 3 inch planks placed 15 feet apart were used to stop the velocity of the sleepers, but this proved of no avail and the slide was then divided into two sections, the steeper part being covered in with planks. A little water was admitted to prevent the wood from taking fire, which eventually happened to the lower

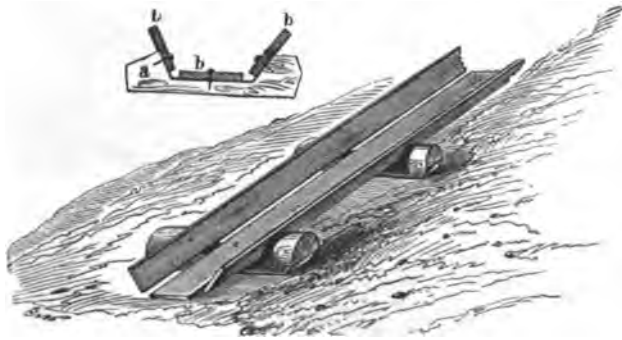

Fig. 200.—Plank-slide.

part of the slide, down which the sleepers went with great velocity.—Tr.]

Plank-slides are used extensively in the Black Forest. If plank-slides are to be used for the export of large quantities of timber they must be constructed strongly, but when only for temporary use, the sections are lightly built and portable, as shown in Fig. 200. In this case the ends of the planks are sloped off and fastened by screws to those of the next section. These portable slides are used for firewood in the Sihlwald, near Zurich.

(c) **Wet Slides.**—The description of slides will be completed by an account of wet slides, which must be made as nearly water-tight as possible, so as to hold a moderate stream of water; therefore they must be constructed much more carefully than dry-slides.



Photo by]

PLATE V.

[F. Gleadow, I.F.S.

HIMALAYAN WET-SLIDE BRIDGE.
Crossing Chasm 90 feet wide and 80 feet deep.

[To face p. 323.

As Fig. 201 shows, they are made generally with eight hewn poles, the sides of which fit closely, and the interstices are stopped with moss, or with tarred tow, etc.

[A wet slide in the Deota Forest in Tihri-Garhwal in the N. W. Himalayas was constructed in 1876-78, being 12,192 feet long with a fall of 1,300 feet, the gradients from 1 in 14 to 1 in 2.5, and the best gradient 1 in 4. It consisted of a trough composed of three planks (12 feet \times 13 inches \times 5 inches) roughly joined and firmly wedged into block-sleepers. Being made of *Pinus longifolia*, the latter only last 3 or 4 years, but should be made of deodar-wood, which is very durable in the hill-districts of India. The slide is worked by means of a good flow of water, which is supplied by troughs at intervals of about a



Fig. 201.—Wet slide.

quarter of a mile, a good depth of water being required when the gradient is less than 1 in 3. When there is plenty of water, 1,200 railway-sleepers can be passed down in about 10 hours, each sleeper taking ten minutes on its journey. Such slides cost about 16*d.* a yard in India.* Fig. 202.—Tr.]

For short wet slides, where there is a plentiful supply of water, preference should be given in their construction to merely hewn poles, instead of planks, as repairs are thus facilitated. Water is brought into the slide whenever it passes any stream or spring. In the Salzkammergut, planks are used in a similar way to the Tihri-Garhwal slide. In California, hundreds of miles of wet timber-slides have been constructed as shown in Fig. 203.

* An account of this slide is given in the working-plan of the Tihri-Garhwal Forests by N. Hearle, published at Allahabad, for the Government of the N. W. Provinces, 1888.

(d) **Gradient.**—The amount of gradient is a most important consideration in constructing slides. Too small a gradient renders a slide useless, with too great a gradient the wood will leave the slide and great danger arises to any person who may be near at hand. The permissible limits are 5 % and 35 to 40 %, but the way in which the slide is used,

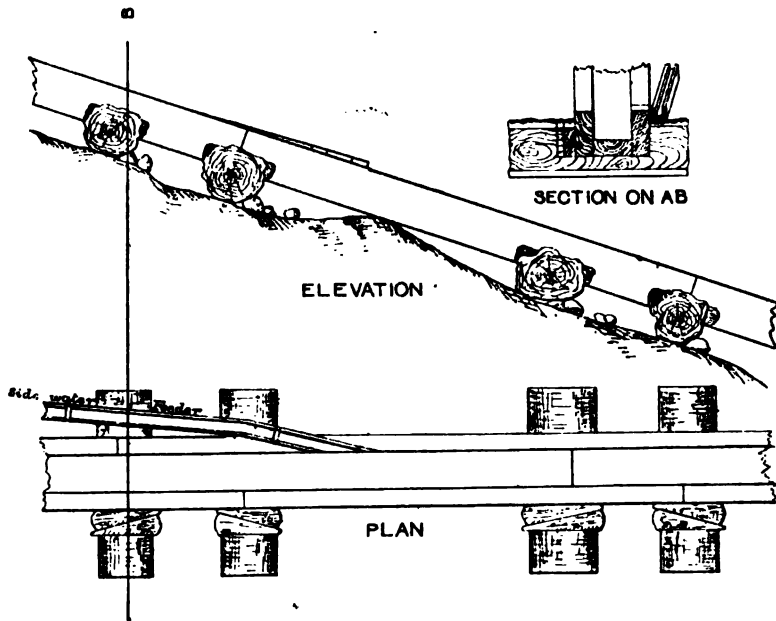

Scale $\frac{1}{4}$ Inch to 1 Foot

Fig. 202.—Deota sleeper slide.

Drawn by T. Marten, Indian Forest Survey.

and the size of pieces of wood to be brought down, affect the question.

Thus there are dry slides, ice-slides, and wet slides.

In the case of dry slides, a steep gradient is necessary, which may go up to 40 per cent. and more.

[If, however, the gradient be very steep, the slide should be fairly straight, as, otherwise, the shocks to which it is subjected by wood coming down causes too much wear and tear. There is also always a danger of fire from friction in dry slides with excessive gradients.—Tr.]

As a rule, however, dry slides become slippery owing to the moist air, or may even contain a certain amount of snow, so that in such cases a lower gradient will suffice than if the slide is used when quite dry, as may be the case in hot countries with scanty rainfall.

In the case of ice-slides, water is introduced into the slide during a frost, so that it becomes coated internally with ice; a very slight gradient is then required.

In wet slides, a thin stream of water is necessary, and should be deeper the steeper the gradient.

Besides depending on the manner in which a slide is used, the gradient will be

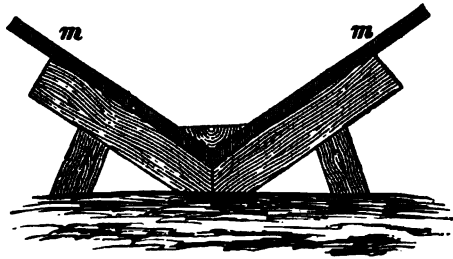

Fig. 203.—Californian wet slide.

affected also by the size of the pieces brought down, so that there are slides for firewood, logs, or scantling such as railway-sleepers, and in the Alps, for billets two to three meters long used for charcoal.

Slides intended for bringing down logs and butts must have lower gradients than those used for firewood, as the former pieces attain a much greater velocity than the lighter pieces of firewood.

The following gradients are usual:—

| Material Transported. | Dry slide. | Ice-slide. | Wet slide. | Remarks. |
|-----------------------|-----------------------|------------|------------|--|
| | <i>Percentage.</i> | | | |
| Firewood | 20—35 | 6—12 | 5—8 | 5 per cent. is 1 in 20. |
| Logs | 15—20 | 3—6 | 3—6 | |
| Charcoal pieces ... | Midway between above. | | | [The data for railway-sleepers result from Indian experience.—Tr.] |
| Railway-sleepers ... | 30 | — | 25 | |

In the case of dry slides, as already stated, the degree of dampness of the air, and the nature of the atmospheric

precipitations affect the surface of the slide, and modify the necessary gradient very considerably.

However desirable it may be to give to each slide the most suitable gradient, the nature of the ground frequently renders this impossible, and the gradient is thus consequently greatly modified. As a rule, by using the sides of a mountain torrent, these slides run more or less directly down to the lower valleys, at whatever gradient the bed of the torrent may render practicable. Slight changes of gradient over a few sections of the slide must be avoided, however, by levelling the base of the slide, either by cuttings, embankments, or constructing viaducts, so that the vertical section of a slide may represent a gradual descent, and there should never be any decided angles between two connected sections. [Plate IV. shows a slide crossing a mountain ravine in the Himalayas.—Tr.]

It is also necessary to secure steeper gradients in the higher portion of the slide than for the lower portion, so that the latter may more and more approach the horizontal direction; the last few sections of it may even ascend, and the longer the slide and the heavier the pieces to be sent down, the more this must be accentuated. As regards the horizontal plan of a slide, it should be straight or form a steady curve without sharp corners, especially for long logs.

(e) **Collecting-places for Wood.**—In high mountainous districts the configuration of the ground will not allow always of the construction of a continuous slide from the lofty ridges down to the valleys, and several transport-works may be made, such as sledge-roads, slides, wire-tramways, etc., according to the nature of the ground in each part. In order to collect the wood coming down from one side to another lower one, a collecting-place may be constructed. It is barred with stout poles with side palisades and has an aperture below, into which the expanded upper end of the next section is inserted to receive the wood for the next stage of the descent.

(f) **Maintenance of Wooden Slides.**—Wooden slides are either permanent or temporary, the former serving a certain forest tract for a series of years, or connecting a collecting depot high up in the mountains, to which the wood is brought

in sledges, with a lower depot in the valley. Such a slide must be constructed most carefully and strongly, the site for it well chosen, and the gradients very carefully arranged. Temporary slides are used in bringing-down wood from the upper to the lower part of a felling-area, or to a road, and are constructed in a much lighter and less expensive way than permanent slides. They may be made with portable segments (p. 322).

The construction of slides requires a large quantity of wood, and this is further increased by the slight durability of the latter, for although slides may last longer in damp, shady places, and shorter on sunny aspects, yet they rarely last more than 7 years, and usually repairs are required after 3 or 4 years.

[In the Himalayas, deodar-wood is so saturated with oil, that its heartwood is practically imperishable in mountain districts; timbers in bridges in Kashmir exposed to alternations of damp and dryness have lasted for hundreds of years, so that very durable timber-slides may be made of deodar.—Tr.]

As progress is made in the construction of roads, slides become less important; at any rate, this applies to slides several miles long, which were formerly so prevalent on the southern declivity of the Alps, where the best constructors of slides are to be found.

Shorter slides, however, intended to complete communications over steep ground, are still employed extensively in the Alps and other mountain-ranges, and their use is increasing.

2. *Ground-slides.*

Ground-slides are tracks often found on mountain-sides, and are made either on the bare ground by the repeated sliding of logs, or artificially improved in various ways, so as to be fit for sliding. As a rule, a depression on a steep slope is selected, a line for sliding dug along it and pieces of wood placed on it transversely on which the logs may slide, other pieces being placed here and there along the edges of the slide to prevent the logs from leaving it.

In the Black Forest wet sloping meadows are used for this purpose, the line of the slide being bounded by logs. In the Alps the method of sliding along the ground often alternates with timber-chûtes. Ground-slides are used for the transport of logs only.

A ground-slide serves its purpose only when its base and walls are sufficiently firm and smooth; therefore all stones, roots, etc., must be removed, intervening rocks blasted, the way improved here and there by laying down transverse pieces of wood, while in the more difficult places which have to be traversed short wooden slides are constructed to complete the work.

It is evident that ground-slides cannot be maintained in workable condition for any prolonged length of time. If they have no rocky subsoil they are torn-up soon by drainage water, and may become buried in silt, gravel, and other debris.

Sometimes a wire rope is fastened to the logs whilst they descend a ground-slide. A rope is coiled round a windlass at the top of the slide so that as a log goes down attached to one end of the rope, the other end is wound round the windlass ready to be fixed to another log as soon as the former has reached its destination; often three or more logs are fastened one behind the other, and go down together. The windlass works with a simple brake arrangement. The logs may be placed in trucks and these let down a tramway by the rope.

Although ground-slides should possess steep gradients, yet if they are used when covered with snow or frozen, the gradient need not exceed 20 to 25 per cent., especially when they are well constructed and bounded by logs placed laterally, for in such cases descending logs soon attain a very high velocity.

3. *Road-slides.*

In some valleys leading from the Black Forest, especially those of the Wolf and Kinzig, regularly constructed roadways are used for sliding logs and sledging, as shown in Fig. 204.

It has been laid down already on p. 308 that roads when used as slides should have gradients of 9 to 18 per cent., and more, and should be steepest above and become gradually level

below. Although slides should be as straight as possible, and free from sudden curves and angles, this principle may be

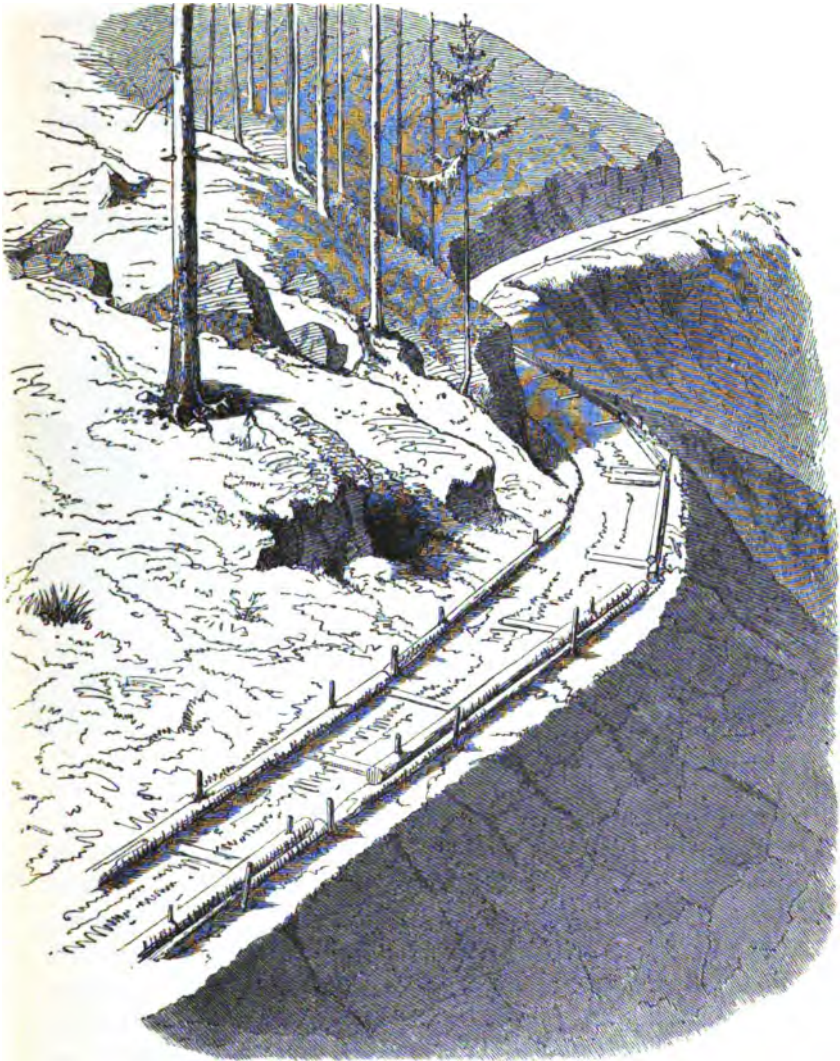

Fig. 204.—Black Forest road-slide.

departed from if the direction of the slide has to change suddenly. A barrier is then erected at the end of a section of

the slide at which the downward section begins, and the log, after striking against the barrier, rolls into the lower section (*m*, *n*), and continues its descent as shown in Fig. 205.

[A similar turning was effected in a fuel sledge-road near Chakrata, N. W. Himalayas, by using a large cart-wheel set on a pivot as a turn-table, on which the direction of the sledges was changed. Fig. 206, show a Japanese method of changing direction in a slide.—Tr.]

The upper end of a slide is generally somewhere near the felling-area. Its lower end should lead to a plot of land sufficiently spacious for the material brought down to be collected and sorted. In order to manage this better the

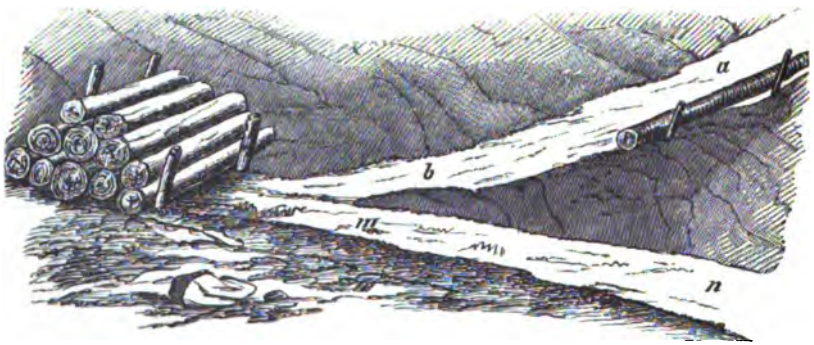

Fig. 205.—Change of direction in a slide.

slide may be divided below into several branches. In any case, it should terminate above a cart-road or stream used for floating.

Once the logs which are to be transported are brought by any means whatever to the head of the slide, they are used to fix its sides, commencing at the top; being placed along the outer sides, or on both sides, of the roadway, supported by pegs either through the logs or outside them, and at such a distance apart as to allow for the easy passage of a sliding log between them (Fig. 204). In order to prevent descending logs from jamming, the distance apart of the boundary logs should be greater on curves than on straight sections of the slide, or the inner side of the slide may be left free. On the outside of curves it may also be necessary to put two or three

boundary logs one above the other, in order to prevent the sliding logs from leaving the slide. In mountain-regions transport on road-slides deserves more attention than has hitherto been bestowed on it; it wastes no wood, is very expeditious, for with a length of 2,000 meters ($1\frac{1}{3}$ miles), 100 to 300 logs may be brought down in a day, and the roadway may be used also for sledges. Sliding on roads is therefore a highly practical method where cart-traffic is impossible.



Fig. 206.—Change of direction in Japanese slide. From a Jap. State publication.

Road-slides are now used in Austria, Galicia, the Carpathian mountains, and in the Salzkammergut. In Hohenashau, in the Bavarian Alps, the ordinary sledge-roads are used in winters without much snowfall for sliding 8-meter logs. They are also used in Franconia, but there only on snow or ice, the transport being chiefly confined to butts for saw-mills.

4. *Mode of Transport on Timber-slides.*

The mode of transport of wood on slides is very simple, and depends on the construction and purpose of the slides. Besides launching the logs the requisite labour-force is employed on the maintenance of the slides.

(a) **Wooden Slides.**—The chief object to be secured in the maintenance of wooden slides is to get as smooth a surface as possible. This may be secured by watering the slide during a frost, so as to get a smooth, icy path; by using the snow which lies on the slide, removing most of it and pressing-down the remainder; in wet slides, by using all available water; or generally, by keeping the slide free from dirt, dead leaves, etc., and using it simply as a dry slide.

Slides are used chiefly during winter or early spring, partly on account of the ice and snow, and partly because the wood must be brought down then, so as to be ready for floating when the water rises in the streams in the spring, dry slides, however, may be used throughout the summer.

Whenever, owing to slight gradients of 5 to 6 %, ice-slides must be used, a good deal of labour is involved in watering, one man being required to water and look after every 40 or 50 sections of the slide. Sliding then is often done at night, when the work has been prolonged into spring, and frost occurs only on clear nights. For the most part slides are used either covered with snow, or dry. The work then consists in removing superfluous snow which may have fallen during the night, and in thoroughly freeing dry slides from pieces of bark, wooden splinters, etc.

Owing to the prolonged use of the principal slides, the bottom pieces get worn-away, and pieces to replace them when necessary should always be kept at hand. During the work of sliding, the logs and other pieces of wood which have been collected at the top of the slide during winter, are thrown in piece after piece, or they may be launched as they arrive at the top of the slide. The work of sliding is done generally by contract-labour. All the wood should be round, except in slides specially made for railway-sleepers or other scantling, and logs should be barked. In clearing the slide of dirt, etc., the men ascend with climbing-irons on their boots.

In all slides, effective means should be assured of warning men below who may be repairing the slide, before any wood is sent down; also when sliding has been temporarily stopped and the woodcutters have gone to fetch more wood, the men below should be signalled to continue their repairs.

[In the Tibri-Garhwal railway-sleeper slide, a wire for an electric bell at the top of the slide was provided along the line, and men were stationed at intervals, so that if by any chance the sleepers jammed, the men above might be warned to stop sliding any more sleepers till matters had been set right below.—Tr.]

In the case of temporary slides, as soon as all the wood lying at the slide-top has been launched, the pieces which have stopped on the way are sent down, and then the pieces of the slide itself are taken up one by one, and sent down the remainder of the slide. Usually the slide leads down to the stream used for floating, into which the wood falls, but if the logs fall on to the ground at the end of the slide, one or two men must be there to roll them out of the way of the succeeding logs, which might cause breakage if they fell on other logs. All this work is very dangerous to people who may be anywhere near the slide, and the workmen must be exceedingly careful to avoid accidents. Sometimes, for instance, a slide crosses a footpath or cart-road, or there may be interruptions in the slide, or difficult places with insufficient gradient, etc. At all such places men must be posted to warn passers-by of danger, and to expedite the logs, etc., which are descending.

(b) **Road-slides.**—In the transport of logs by road-slides men must be posted along the slide; they should place fresh transverse pieces under the logs which are sliding-down, or remove some of these pieces, according to the rate at which the logs descend. They should also repair the roadway, where any damage has been done, signal to the men above and, below them, and generally expedite the work. On such slides only one log descends at a time, and as soon as it has arrived at the bottom of the slide a signal is given to launch a fresh log, which three or four men effect at the top of the slides with *krempe*s.

Road-slides with gradients of 8—12 % can be used only in winter. With a gradient of 12—50 % they may, however, be used in summer, and the logs always descend butt-end first, the ends of the logs being rounded for the purpose.

SECTION III.—FOREST-TRAMWAYS.*

It is only during the last twenty years that iron tramways have been used in forests. At first, forest-tramways were constructed chiefly of wood, of which those by Leo Presti, von Lippert and improved kinds in Austria-Hungary by Egetz, are the best-known.

Decauville's portable railways, which were used in France for agricultural purposes, have proved thoroughly adapted for timber-transport, and have found many imitators in Germany. Although there may be differences of detail in the various kinds of tramway in actual use, yet the chief points to be secured are **easy transportability** of the plant combined with **strength and solidity of construction**.

Monorail Tramways are used in America, and in 1898, de Coulon constructed a monorail tramway from the forest of Neufchâtel in Switzerland.† There is also a system of conveying trucks on a strong level wire, supported by trestles, where the motive power is supplied by a stationary steam-engine.

1. *Kinds of Tramways used.*

If forest-tramways are to be thoroughly useful for timber-transport, they should start from the ordinary country lines of communication, and penetrate along the main and subsidiary forest roads into the interior of the forest as far as the felling-areas, and even up to the individual felled trees.

It follows that some of the lines should be permanently constructed, that a second portion should be more or less portable, and that those sections of the tramways which reach the felling-area should be of a light portable nature.

It is evident that in certain cases the line cannot be continued up to the felling-area, whilst in other cases the portable parts

* Runnebaum, "Die Waldeisenbahnen," Berlin, 1886.

† "Indian Forester," Vol. XII., 1886, p. 244, for an account of a forest-tramway used at Kottenforst, near Bonn, by Sir D. Brandis, K.C.I.E., and Colonel Bailey, R.E. Also cf. Mathey, "Exploitation des Bois," Vol. I., 1906, where is a very detailed account of tramways.

† The Monorail Portable Railway Co. (Caillet's Patents), 22, 23, Lawrence Pountney Lane, Cannon St., London, E.C.

of the tramway communicate directly with the permanent way, and the half-portable portion is not required. In fact, all lines do not include the three kinds of tramway already mentioned.

2. Mode of Construction.

This includes **laying-out the road, the rails and sleepers, the rolling-stock and apparatus used for loading the trucks.**

(a) **Laying-out the Road.**—Ordinary forest-roads will suffice



Fig. 207.—Rail.



Fig. 208.—Iron sleeper.

for the main tramways and the half-portable way. They should be as straight as possible, and there should not be much range of gradient, which may reach 8 or 10 % though moderate gradients from 0 to 6 % are preferable. The sharpest curves should have 60 to 100 feet radius.

For the main and secondary lines, earthworks to improve the gradient cannot be dispensed with, but the portable

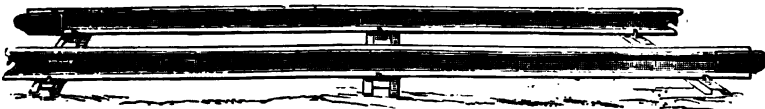

Fig. 209.—Portable pair of rails.

portions of the railway must run according to the lay of the ground.

(b) **Rails and Sleepers.**—Flange rails (Fig. 207) of the best Bessemer rolled steel are used. Transverse sleepers only are used. For the main lines wooden sleepers are used, but for the portable portions of the line steel sleepers (Fig. 208) are required, and these sleepers are strongly and permanently united to a pair of rails, constituting a section as in Fig. 209. The rails are 6 to 8 meters long in the main lines, but only 2 meters long on the portable lines, and a section must not be heavier

than a man can carry (Fig. 210), *i.e.*, 35—45 kg. (76—100 lbs.). Whilst on the main lines consecutive rails are fastened

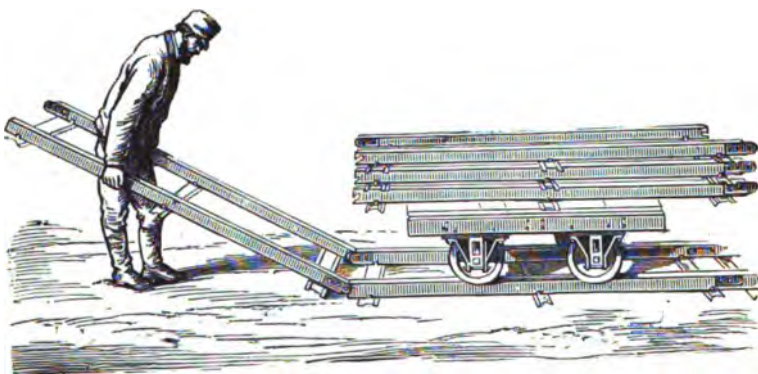

Fig. 210.—Laying the lines.

together by plates and bolts, in the portable portions they must be attached so as to link and unlink with one another



Fig. 211.—Fastening for the rails.

quite easily, as shown in Fig. 211. This costs sixpence a meter cheaper than the usual method of fastening rails,

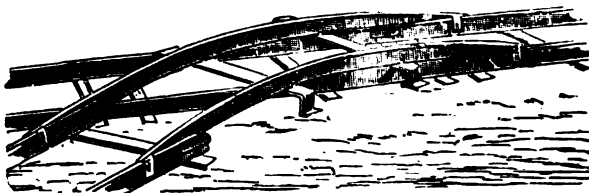

Fig. 212.—Junction between two lines.

while the cost of maintenance of the portable lines in 1900 was 45·6 % and in 1901 35·9 %, of the cost of permanent lines.

Bieran, at Schizmede in Elsass in 1898, gave up sleepers and laid heavy steel lines 9 meters long and weighing 16 kg.

(35·2 lbs.) directly on the road. The rails were screwed together every 1 to $1\frac{1}{2}$ meters by tension rods and joined longitudinally by strong lappets.*

As regards the gauge, experience shows that for main lines 70 centimeters (27 inches), and for portable portions 60 centimeters (23 inches), are most suitable.† Junctions on the main lines are effected by a combination known as switch and points, a description of which may be seen in Dempsey's Practical Railway Engineer, but on the portable lines a junction is effected more easily by means of a curved section placed over the rails, as in Fig. 212.

[Brandis states that at Kottenforst, wooden sleepers are

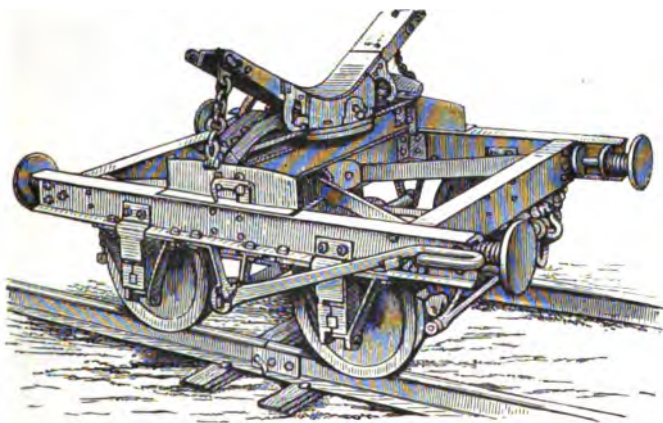

Fig. 213.—Truck for logs.

preferred even for the portable portion of the railway as not liable to bend on uneven ground. Two kilometers ($1\frac{1}{4}$ miles) of branch-railway may be laid by two men in a day. With two wooden sleepers, one at each end, a section weighs 38 kilos = 84 lbs., but the rails must be heavier than when more sleepers are used, 8 kilos per meter.—Tr.]

The main lines might be constructed in similar fashion to the portable lines, but in their case the rails are 5—6 meters long, instead of only 2 meters, and the sleepers 80 centimeters

* Bieran, Verlegbare Bahnen ohne Schwellen, Allg. Ft. u. Jd. Zeitung, 1899, also 1902.

† [So Gayer, but change of gauge is of doubtful efficacy.—Tr.]

to 1 meter apart, instead of being only at either end of the portable sections, so that two men are required to lift each

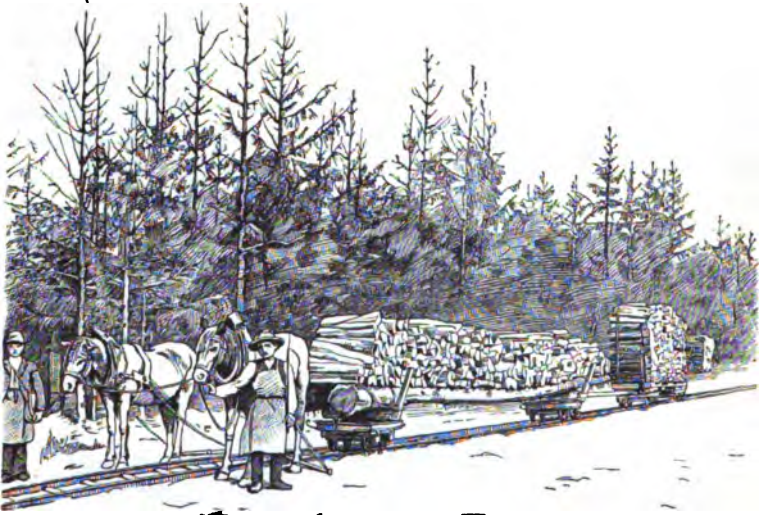

Fig. 214.—Transport of firewood.

section instead of one man. It is also greatly preferable to use wooden sleepers for the main lines.

(c) **The Rolling-stock.**—The rolling-stock, or trucks used



Fig. 215.—Lading the trucks.

for transport, must, though strongly built, be as light as possible. It is clear that these trucks must be constructed most carefully, when it is remembered that heavy logs are to

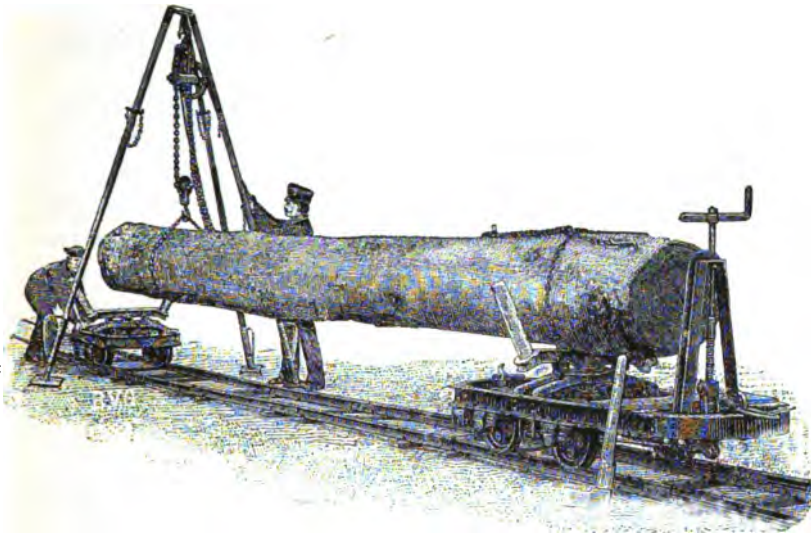

Fig. 216.—Simple crane.

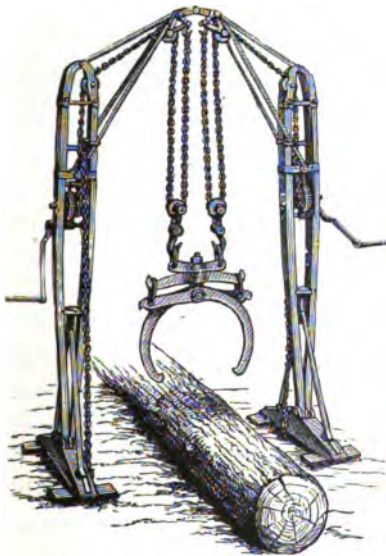

Fig. 217.—Double crane.



Fig. 218.—Windlass.

be carried, and that the workmen incur considerable danger in moving such heavy pieces of timber. At the same time light trucks are essential, especially on lines with a gradient

up to 7% and without steam-power, as they have to be dragged back to the felling-area by horses; as far as possible they should be made of wood.

The trucks are constructed below like ordinary railway-trucks, but they support a revolving horizontal plate furnished with an iron crescent-shaped support, or a horizontal bed with inclined arms, on which the logs rest as shown in Figs. 213, 214. These revolving plates allow of a log resting on two trucks being taken round curves. Each truck is provided with a brake, and different kinds of brakes are used.

For the transport of firewood the revolving plate is not required, but the truck forms a platform at its surface, and uprights are supplied on both sides to support



Fig. 219.—Windlass for lading.

the wood. Evidently the transport of logs can be conducted only by means of two trucks; firewood also may be piled on two trucks over two scantlings placed longitudinally (Fig. 214).

(d) **Apparatus for Lading the Trucks.**—In using forest tramways all suitable mechanical appliances for saving labour should be provided. Although in lading trucks with poles and other light pieces manual labour alone is required (Fig. 215), cranes are supplied for lifting logs on to the trucks. Fig. 216 represents a special tripod crane, Fig. 217, a double crane capable of lifting $4\frac{1}{2}$ tons, which may be separated into two parts for convenience of transport and Fig. 219 an improved timber-loader constructed by Haarmann at the Osnabrück steel works. [This is said by Brandis to be the safest method for the workmen.—Tr.] Finally, Fig. 218 shows an improved

windlass, which is very effective, the method of loading by means of it being shown in Fig. 220.

How useful it is to have recourse to machinery, in case of extraordinary demands on labour, was seen in 1891 and 1892, in Brannenburg in Upper Bavaria, when thousands of large logs from trees killed by the "Nun" moth caterpillars in the



Fig. 220.—Method of lading.

Ebersberg Forest were laden on to trucks by a steam-crane as shown in Fig. 221.

By means of one of these cranes the log is raised high enough for the rails to be laid under it, and the trucks pushed on to them, when the log is lowered and fastened by chains on to the trucks. Heavy logs must be laden by means of cranes, and only smaller ones by the use of levers. In the case of firewood there is no difficulty in loading the trucks.

[The cost of 6 miles of tramway (4 main lines and 1½ miles



Fig. 221.—Steam crane for lading logs.

branches) at Kottenforst, rolling-stock, loading apparatus, and laying-down 4 miles of main line, in which £40 was spent on earth-work, was £252 per mile and it is estimated to last for 15 years.—Tr.]

3. *Mode of Transport.*

A distinction may be made in forest-tramways according to the means used to work them: merely utilizing a down-incline

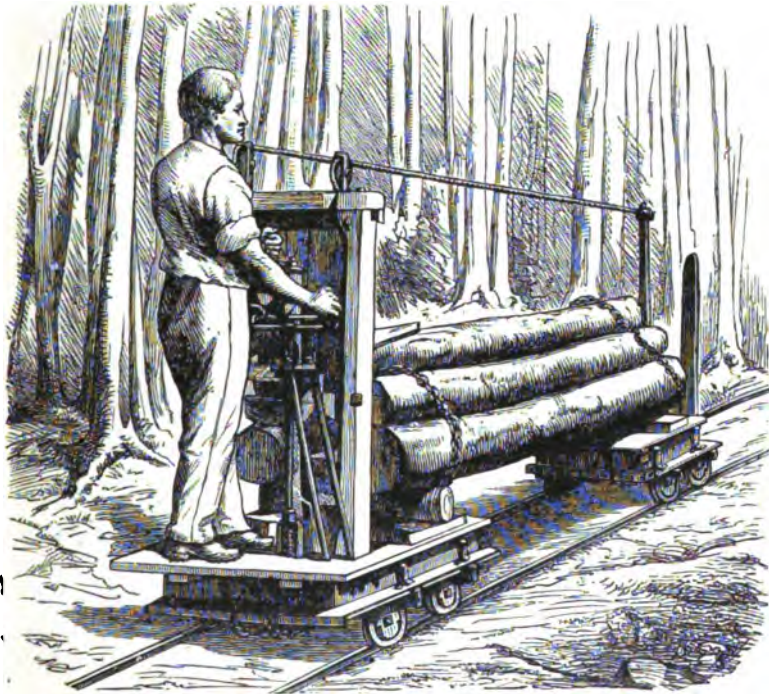

Fig. 222.—Use of brake.

of the line of road; dragging the trucks by means of horses or men, or finally by locomotives.

Where the *incline of the roadway* is used, there must be a fall in it of about 3 to 4 %, and the trucks must be provided with suitable brakes. The empty trucks are dragged back by horses and less frequently by men. This method is employed for short distances wherever the ground is suitable, and is represented in Fig. 222.

Horses are used on nearly all branch-lines which are constructed in level land, even when of quite a temporary nature. The horses do not pass between the rails but alongside of them; they are accompanied by drivers and other men, especially when several trucks are united so as to form little trains (Fig. 214). Brakes are always required.

At present on the main lines, as in Elsass (Schirmeck, Alberschweiler), also at Schneegatten in Upper Austria, locomotives are used almost everywhere, unless the lines are very short. The locomotives are small; in mountainous forests specially constructed, light, mountain-locomotives with 3 axles are used, which can travel on curves even with a radius of 25 meters (80 feet). In this case the brakes must be very effective. If the main line is of the ordinary railway-gauge, the usual kinds of trucks are used in trains of different lengths, as in the forest of Ebersberg, where 190 truck-loads leave the forest daily, the total annual yield of the forest in timber being 45,500 truck-loads.

The loading of the trucks is effected by rolling or sliding over inclined poles as shown in Fig. 215; also special machines for loading are used, and wherever the timber is transferred from trucks of one gauge to those of another, cranes are indispensable.

Whether the construction and working of a forest-tramway is best undertaken by the forest management, or by a contractor, is a question which cannot be answered in a general way; the nature of the locality, volume of wood to be transported, length of the lines, greater or less delay experienced in clearing the felling-areas and several other factors, intervene. Circumstances differ materially in the case of tramways which are at present being worked. In general, except in the case of railways of the ordinary gauge, experience has shown that it is more economical to construct and work the lines directly, and not by contract; this is quite independent of the advantage to the forest-owner in having, in the former case, more freedom in the management of his forest.

Main lines in complete unison with the ordinary railway system of a country should be constructed and managed

by railway engineers. Thus the 12 kilometers ($7\frac{1}{2}$ miles) of railroad in the Ebersberg forest were constructed very rapidly by the 1st Pioneer battalion from the Munich Garrison. [Forest-tramways are used in Assam, the Punjab, and other parts of India.*—Tr.]

4. *Statistics.*

The nineteenth century was characterised chiefly by great improvements in machinery and a consequent complete revolution in the means of transport and communications. Forestry should therefore march with the times, and improve the means of transport in forests which are difficult of access. It is a great mark of progress during the last 20 or 30 years, in such a conservative industry as forestry, that a considerable extension of forest-tramway has taken place.

Dozens of forest-tramways have been constructed in Germany during the last ten years, and there is scarcely a German province in which either a permanent or temporary tramway is not being worked. The first steps in this direction were taken in North Germany, in the different Prussian and Saxon provinces, and South Germany has followed suit, partly owing to the enormous volumes of timber following the great destruction of forests by insects, or storms, in South Bavaria, the Vosges Mountains and Würtemberg. The oldest forest-tramway is that of the Sihlwald, near Zurich (Fig. 230).

The most important forest-tramway hitherto made on level land in Germany was constructed in 1889—92 to remove the enormous volume of timber (4 million cubic meters, or $2\frac{3}{4}$ million loads) which had been killed by the "Nun" moth caterpillars, in the forests of Ebersberg, Perlach, Sauerlach and Forstenried. This tramway consisted of 12 kilometers ($7\frac{1}{2}$ miles) of main line of the ordinary gauge, from the railway-station of Kirchseeon, passing through the middle of the devastated forests, with 40 kilometers (25 miles) of branch-lines, a gauge of 60 centimeters (say 2 feet), and 27 kilometers (17 miles) of portable lines which passed right up to the

* "Indian Forester," Vol. XII., p. 349 gives an account of the Changamanga tramway in the Punjab.

felling-areas. The construction of this tramway was commenced in August, 1890, and it was opened for transport by the beginning of December of the same year, but has now been removed entirely. The most recent level forest-tramway is that 15 kilometers long at Rheintessen from Sprendling to a depot on the River Main. This depot covers an area of $12\frac{1}{2}$ acres and affords convenient quays for lading boats with timber.

The forest-tramways in the German Vosges near Barr, Rothau and St. Quentin are the most important mountain-tramways hitherto constructed. Owing to the nature of the locality, consisting of narrow winding valleys, frequently with steep gradients, many difficulties were encountered during the construction of these tramways, and deep cuttings, viaducts, bridges and double curves are frequent. Thus, the Schirmeck tramway, 40 kilometers long, with a gauge of 70 centimeters, and worked by locomotive power, ascends 501 meters (1,612 feet). The branch-lines of similar construction to that of the main line are 16 kilometers long, with a maximum gradient of 7.14%.

[In the State forests near Schlettstadt on the river Ill, in Alsace, that are liable to inundations and where the construction of roads is very costly owing to the spongy nature of the ground, short portable tramways are used to transport the heavy oak and other timber to the banks of the Ill.—Tr.]

For a discussion of the value and suitability of forest-tramways, as compared with other means of transport, the reader is referred to p. 480 of the present book.

SECTION IV.—WIRE-TRAMWAYS.

At the end of 1850, the first wire-tramways of the simplest kind were erected in order to convey bundles of firewood and faggots weighing up to half a cwt. down precipitous hillsides. A stout iron wire was used for this purpose, which descended the valley with a gradient of 25—30% and on which the transported material passed hanging by a hook, or a twisted withe.

This simple arrangement has led more recently to continual

improvements at several places in Switzerland, the Tyrol and Germany, with the object of transporting larger pieces of wood, and especially logs and butts for sawmills. At present there are two kinds of wire-tramways, those with one or two wires.

1. *Double Wire-Tramways.*

These consist of two wires about 3 centimeters or 1 inch thick, each of them composed of a wire-rope made of 6 strands

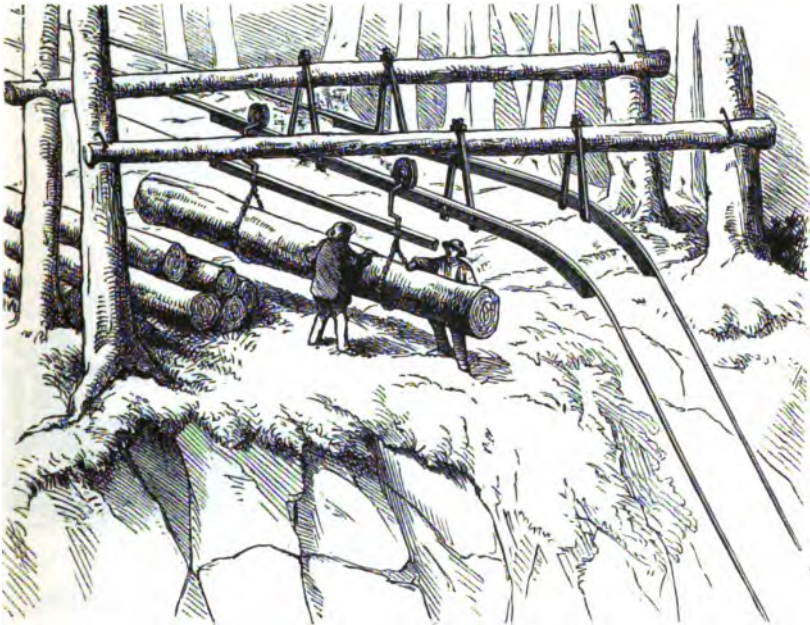

Fig. 223.—Gündlischwand wire-tramway.

of wire closely twisted round a hempen cord and extending without supports from the top to the bottom of a declivity. One serves for the descent of laden cars, and the other for the ascent of the empty ones. The upper ends are fastened to large trees and run over a pair of iron rails, which are curved downwards in front (Fig. 223). The lower ends are wound round horizontal cylinders, which can be turned by means of levers and cog-wheels, so as to stretch the wires (Fig. 224).

The log which is to descend the wire, is suspended from it

by chains from two wheels (*a a* Fig. 225) running on the wire and kept at a suitable distance apart by a rod (*b*). This arrangement is termed a truck. Were the laden truck left to itself, it would descend with constantly increasing velocity down the wire, and smash the wood and itself at the end of its course. In order to prevent this and control the course of the truck, a second and more slender wire (*S* Fig. 225) is attached to the rod (*b*), and is wound round two rollers at the upper end of the tramway, so that the truck may be let down and drawn

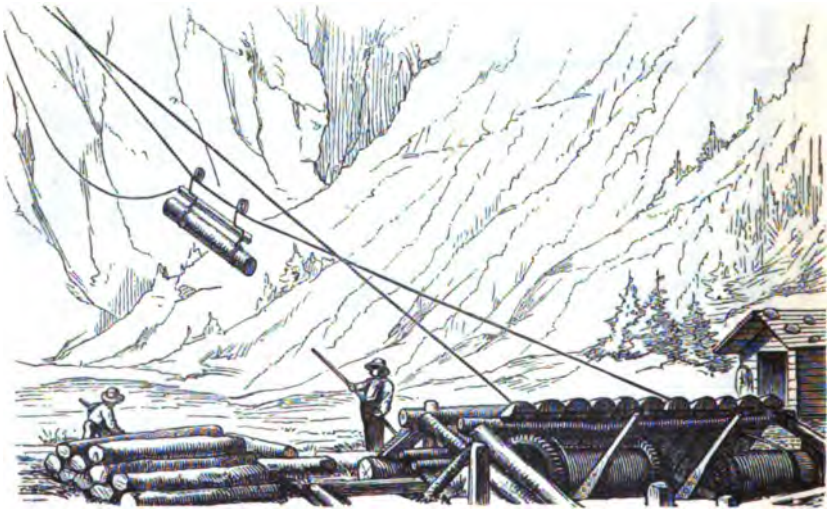

Fig. 224.—Lower end of a wire tramway.

up again empty. These rollers also serve as a brake to regulate the speed of the truck.

The wire-tramway at Gündlischwand in the Grindelwald, which is shown in Figs. 223 and 224, is 4,300 meters (say 14,000 feet long), and the wires hang quite freely without any support at an angle of about 26 degrees. Another double wire-tramway has been constructed in the forests of the Count of Stolberg-Wernigrode. It differs from the preceding one owing to its moderate gradient and because the wires are supported at several points by bent iron rods (Fig. 226) attached to horizontal poles (*m*) supported by trestles.

In Fig. 226, (*a*) is the wire and (*c*) wheel of the truck.

This tramway is supplied with a special windlass for dragging logs up to it from distances of 200 meters by means of a wire.

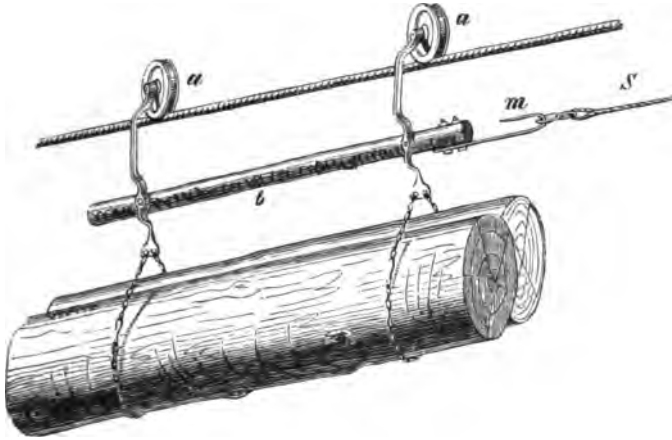

Fig. 225.—Truck for wire-tramway.

The Prince of Schwartzenburg has similar wire-tramways in his forests in Böhmerwald. The largest wire-tramway of this class is at Roveredo, and is 5 miles long.

[In the Bamsu wire-tramway in Tihri-Garhwal, in India, described in "Indian Forester," August, 1897, page 283, there are 3 spans with a total length of 1,825 feet, used to connect two sledge-roads, Bullivant's patent steel $\frac{3}{4}$ -inch diameter wire-rope. Two spans (634 and 432 feet) single wire, other span 759 feet, the steepest, double endless wire running round two drums with vertical axles. Oak saddles are used to support the sleepers as they reduce friction. Tension applied by means of rough winches. The double wire works best, and 250 sleepers per diem were carried, but after 20,000 sleepers had been passed down, wear and tear was so great, that carriage by coolies at 8 pies per

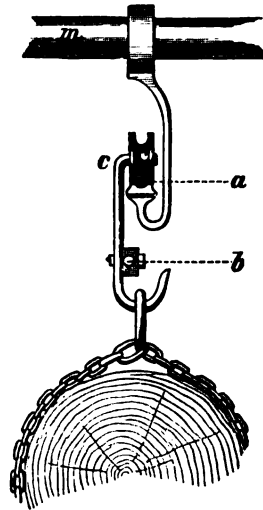

Fig. 226.—Truck.

sleeper was equally cheap. However, the construction of the wire-tramway reduced this charge by 25 % from 1 anna to 8 pies. The gradients are 26 and 27 degrees for single wire and $31\frac{1}{2}$ degrees for double wire.—Tr.]

2. Single Wire-Tramways.

In single-wire tramways, the laden and empty trucks travel at the same time on a single wire; otherwise their construction is similar to that of the double-wire tramways, the only peculiarity in this case being the arrangement for allowing the empty and laden trucks to pass one another on the wire.

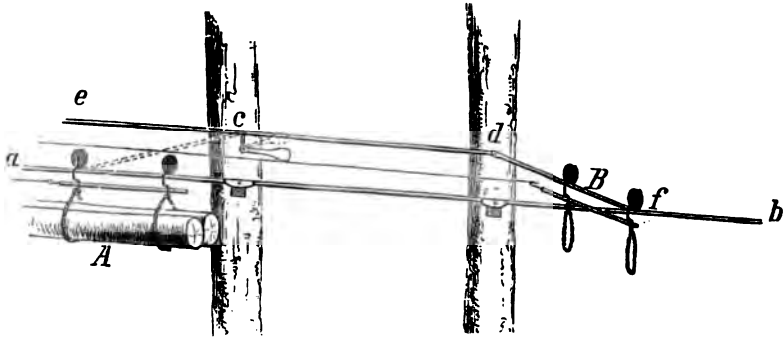

Fig. 227.—Transfer station.

To allow for the possibility of this, at the middle of the wire, where the trucks cross one another, a so-called transfer-station is arranged as follows: a workman stationed on a scaffolding lifts the empty truck from the wire and replaces it beyond the descending truck so as to allow the latter to pass.

An automatic siding has, however, been invented, as shown in Fig. 227: at a short distance above the wire, is fixed, on the poles (*c d*) which serve to support it, a rod (*e c d f*) for the passage of the empty truck. The part of this (*e c*), jointed to the remainder by a hinge at (*c*), has also a counterpoise, so that it remains parallel to the wire unless pressed-down by the weight of the truck, (*c d*) is fixed parallel to the wire, and (*d f*) is also jointed at (*d*) and meets the wire at (*f*). The empty

truck *B* on reaching (*f*) ascends (*f d*) and passes from (*d*) to (*c*) whilst the laden truck passes under it, and then rejoins the

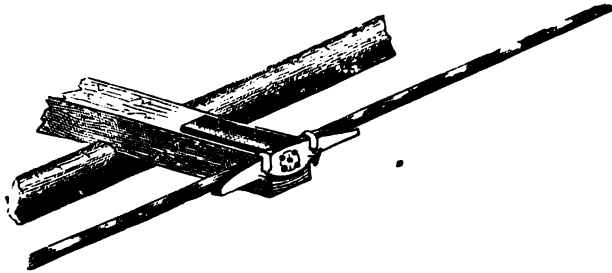

Fig. 228.—Method of supporting wire.

wire by pressing down (*c e*). The laden truck *A* on reaching (*f*) lifts up (*d f*) and passes on its way.

The first single wire-tramway was constructed in Schlieren-

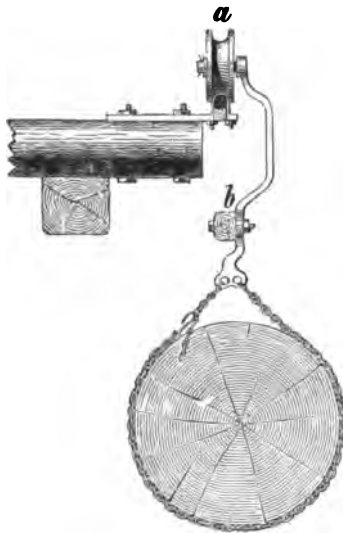

Fig. 229.—Truck.

thal near Alpnach, in Canton Unterwalden, in Switzerland, it has a length of 2,100 meters (1 mile 3 furlongs) and is supported at numerous points, with a gradient of 35%. It differs from the tramway just described by the fact that the wire is

supported at the end of horizontal rods to which it is fastened by plates and bolts, so that the wheels of the truck may pass freely over it (Fig. 228). The iron rod of the truck supporting the log is also bent outwards (Fig. 229).

Single wire-tramways have been constructed in the Salzkammergut, in Carinthia, and other places on the southern declivity of the Alps. In Canton Tessin, Switzerland, there are 141 double or single wire-tramways.



Fig. 230.—Forest-tramway in the Sihlwald.

CHAPTER IV.

WOOD TRANSPORT BY WATER.*

TRANSPORT of wood by water consists either in floating logs, scantling or firewood, piece by piece, down streams, or in rafting them, after they have been bound together in rafts.

This is the oldest form of transport known, and is referred to in the Bible in 1 Kings v., when Solomon rafted large cedar logs from Tyre for the construction of the Temple at Jerusalem. In the Roman provinces of Germany, only logs were floated, the floating of firewood being a more recent industry. At present, timber-transport by water is carried on more or less in many streams, especially in mountain-regions where it is most highly elaborated.

SECTION I.—FLOATING.

Under this section the floating of single pieces of wood to their destination will be discussed.

The section describes:—the natural suitability of any stream for floating; artificial improvements of streams; erection of the works necessary for the maintenance of a proper supply of water and for catching the wood at its destination, and the methods employed in floating wood.

All streams cannot be used for floating wood: they may be too weak or too strong, with too narrow or too wide beds; they are sometimes too winding; bad banks, rocks, boulders, etc., may interfere with the floating in an otherwise suitable stream, or floods may effect serious damage. In the most favourable cases similar protection must be afforded to the floating-channel, as to a stream driving water-mills or other

* There is very little literature about water-transport of wood. The best German works are—Förster: "Das forstliche Transportwesen." Vienna, 1885. Barth, "Die Geschichte der oberen Kinzig." 1895.

hydraulic works, and manual labour is required to conduct the floating. Hence floating has become a highly elaborate undertaking, in the carrying-out of which many costly constructions and protective works are needful.

1. *Conditions necessary for Streams to be Utilizable.*

Independently of artificial improvements which may be effected, a watercourse used for floating timber must possess certain natural peculiarities, depending on the direction, power and fall of the stream. The direction must eventually lead to the timber-markets, however much the stream may wind on the way there. Not unfrequently artificial channels are cut in order to shorten the course of the stream.

The minimum width admissible is the length of the logs to be floated, as, unless they have room to turn, constant blocks will occur during floating. Only in the case of artificial floating-channels, where the banks are quite smooth, and butts for saw-mills are floated, may the width of the stream be less than the length of the logs.

The maximum width of a stream used for floating depends on the possibility of securing and extracting all sunken wood by means of ordinary appliances. Even with the best management some of the heaviest logs will sink, and this sunken wood is either carried along the bottom of the stream, or sticks in holes in its undermined banks. In very broad streams sunken wood cannot be guided to the shore or otherwise secured. Hence, unless the logs are being rafted, the breadth of streams used should not exceed that of a large brook, or small river.

The depth of the water is also an important point; this should be sufficient to float water-logged timber which will not quite sink, without danger of its grounding on the bottom of the stream. Long and slowly running streams should be deeper than rapid streams, which carry the timber better where the distance for floating is short, and there is, therefore, less chance of the wood becoming water-logged. When large, round timber is floated, a greater depth is necessary than for poles and split wood, which are easier to float.

When thoroughly dried, all woods indigenous to Northern Europe will float, but heavy, broadleaved species lose this faculty much more quickly than coniferous wood; so that while the latter may be floated in the round for great distances, this is not possible with the former. [Of coniferous wood, that of pines and cedars rich in turpentine floats much longer than that of spruce and silver-fir. Experience in India has proved this fact.—Tr.] Generally water-logged wood floats vertically. The best depth for floating coniferous logs and split pieces of hardwood is one and a half to three feet, as then the workmen always can wade into the water to secure the sunken wood.

There is no necessity for any uniform fall in a stream, and most streams used for floating timber vary greatly in this respect. The best fall is $\frac{1}{200}$ to $\frac{1}{70}$, as then the wood descends rapidly and is guided easily by the workmen; there is also little wear-and-tear owing to the pieces dashing together or against rocks, that may also cause continual blocking of the stream and necessitate severe labour to set the logs floating again. Floating, however, has to be undertaken frequently with a fall, less or much greater than the above. In the latter case, cascades have sometimes to be passed, and much timber is lost.

Rafting can be done with much less fall, and artificially-constructed or improved rafting-streams have falls of only $\frac{1}{500}$ to $\frac{1}{400}$.

The last point to be considered in the practicability of a stream for floating timber consists in the possibility of damming its tributaries artificially, so as to collect temporarily a much greater head of water than it usually holds.

There is much periodical variation in the amount of water in a mountain-torrent, and sometimes a formidable, destructive torrent may be seen where a few weeks later there will be merely a little thread of water. In other cases a stream may be always too low for floating, but by collecting the water of its tributaries, enough water may be obtained to float down a sweep of logs.

2. *Improvement and Maintenance of Watercourses for Floating Wood.*

No watercourse is constantly fit for floating without some artificial improvement, but all streams are not susceptible of the same amount of improvement; in many cases the low value of the timber to be floated will not allow of much expenditure at a profit in this direction, and sometimes the forester has to put up with the mere maintenance of the natural state of a stream. Hence, the works on no two streams used for floating resemble one another. In the following pages the most perfect methods of improving and maintaining a floating-channel are described, so that the forester may select what is practicable in any particular case.

The improvements consist of:—**increasing the head of water** in a stream according to requirements, beyond its average quantity; **regulating the course** of a natural stream; **constructing an artificial channel** to replace it, and **booms** to stop and collect the floated material.

(a) **Increasing the Head of Water in a Stream.**

Besides rivers such as the Inn, the Isar, the Oder, etc., which are constantly used for timber-floating, nearly all German mountain-streams require arrangements for raising the average height of their water. It is especially the higher parts of streams, near their sources, where this is most necessary, for there they contain the least amount of water and pass through forest areas where floating is most necessary. The means used for increasing the water are:—**lakes and ponds, feeding-canals, dams and tanks.**

i. *Lakes and Ponds.*

In valleys and mountain-depressions at a high elevation, natural reservoirs such as lakes and ponds are of frequent occurrence, especially in high mountain-ranges with masses of snow and glaciers, where lakes of different sizes are frequently found in the upper stages of the side-valleys. These permanent water reservoirs are very valuable, for they usually

lie along the line of floatage, and by means of a simple sluice at the outlet of a watercourse from a lake, the level of the latter may be maintained high enough to furnish a good head of water for floating wood down the stream. Many lakes are thus utilized.

A small lake from which a side-stream passes into the line of floatage, or which may be connected with it by a canal, may also be utilized similarly, and in both these cases the dams to be constructed are similar to those that will be described further on.

ii. *Feeding-canals.*

Instead of lakes and ponds, watercourses near the floating-channel may be utilized to raise the water-level of the latter by leading their water into it. A mountain-range, through the principal valley of which the floating-channel passes, is often a rich water-collecting basin, its springs and brooks running through the forests; if here, not only the less important springs, but also the brooks of adjacent valleys, are united to the floating-stream by canals, and its tributaries provided with sluices, the best possible measures will have been taken to gain a sufficient water-supply.

Lines of levels should be run for these projected feeders, which often must be conducted round spurs and precipices so as to secure, if possible, a uniform fall, which should rarely exceed 3 or 4 ‰, or serious damage may ensue. Sluices are required where the feeder leaves the brook the water of which is to be utilized, and also where it joins the floating-channel, so that swollen torrents may be avoided, and water admitted to the latter only when it is required. It must not be supposed that it is always a difficult matter to lead water from one basin into another, for in the upper parts of a mountain-range several streams may be quite adjacent, which diverge widely lower down; the feeding-canals also are not difficult to construct, being usually mere trenches like those used in irrigating meadows, and it is usual to utilize only tributaries of the same stream that eventually join it lower down.

The direct line of floatage is not often supplied by feeders, but frequently they are used to fill reservoirs.

iii. *Dams and Reservoirs.*

Whenever lakes and ponds are not available, the water of the floating-stream itself may be dammed-up, and thus a stronger head of water obtained. This is secured by means of a **dam** furnished with a **sluice-gate**, that is erected transversely across the valley in which the stream runs so as to maintain the level of the water behind it. A **reservoir** is thus formed, the water in which may be made available for floatage when required, by opening the sluice-gates.

There is much variety in the mode of construction of dams, and according to the material used for them, they are made of earth, wood or masonry. The chief point is to make the dams and sluices watertight; cemented masonry-dams are best in this respect, but earth-dams are superior to wooden sluices.

(a) **Earth-dams.**—Earth-dams are formed of heaps of earth at the ordinary angle of repose for the material used, as

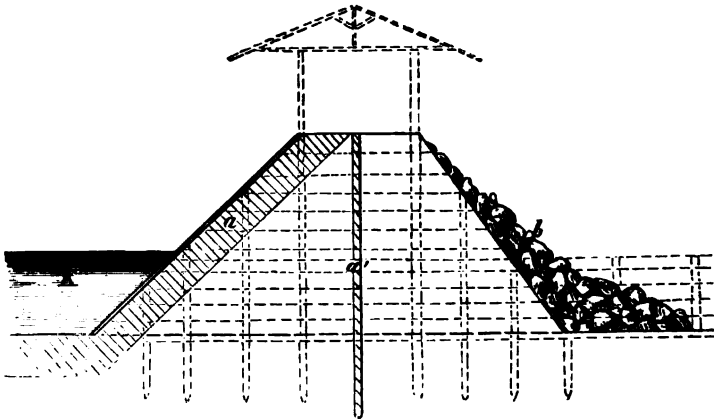

Fig. 230.—Earth-dam.

shown in Fig. 230, which gives the section of such a dam. A facing (*a*) of clay or loam is added to the dam on the side near the reservoir, to make it watertight, and another vertical layer of clay or loam (*a'*) in the middle of the dam will prevent rats from perforating it. In order to strengthen the work, a

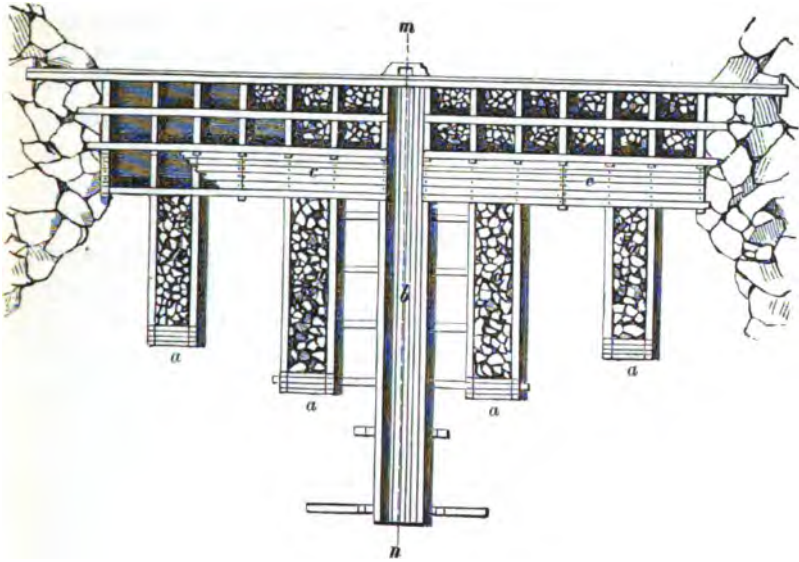

Fig. 231.—The Martin's dam in the Bavarian-Bohemian Forest, that has now been rebuilt in masonry.

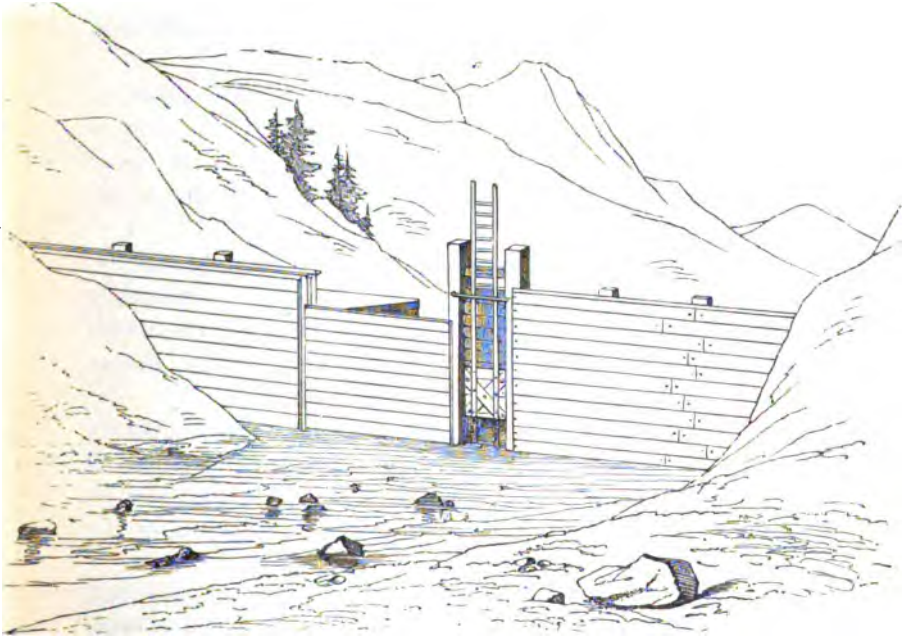

Fig. 232.—Wooden dam at Absdach (Black Forest).

thick facing of rough heavy stones is piled on the side of the dam, away from the reservoir. The impermeability of the dam by water is specially influenced by the nature of the ground on which it rests, and for its site, a place is therefore chosen where there is solid rock, or a clay bed; if this is some depth down, it may be necessary to have artificial clay foundations.

(b) **Wooden sluices.**—Wooden sluices have a framework of wood strengthened by means of earth or stones, usually the latter, in which case the wooden framework is lined with clay and filled with stones. Fig. 231 shows the ground-plan of such a sluice, there being three rows of partitions to be filled with stones. On the side away from the reservoir, these partitions are only half as high as the other two rows, and are planked over (*c, c*). A roof is usually placed over the sluice, and it is crowned by a planked bridge. Buttresses (*a a a a*) of somewhat similar construction to the rest of the sluice are added to strengthen the structure. They may, however, consist only of coarse, dry, stone masonry; *b* is the channel for the passage of the water in the direction *m n*, and is closed by a sluice-gate.

Fig. 232 shows another weaker kind of wooden sluice in the Black Forest, at Absdach, on the river Wolf. It consists of piles boarded over, and strengthened, away from the reservoir, by large blocks of stone between which an opening is left for the sluice-gate.

(c) **Masonry-dams.**—These are built very strongly, chiefly, or entirely, of large hewn stones. As a rule, however, they are only faced with hewn stones, the interior being filled with rammed broken stones, or with gravel or rough stones imbedded in clay; buttresses are then required.

In order to increase their strength, they are frequently made in a regular curved shape, the convex side of which is opposed to the water-pressure, but in that case it must rest on either side on firm rocks, and then resists the pressure of the water like a great vat.

Fig. 233 shows the plan and elevation of a masonry-dam at Herrenwies, in the Black Forest, with two sluice-gates (*b b*); *a a* are smaller gates which are opened first to relieve the

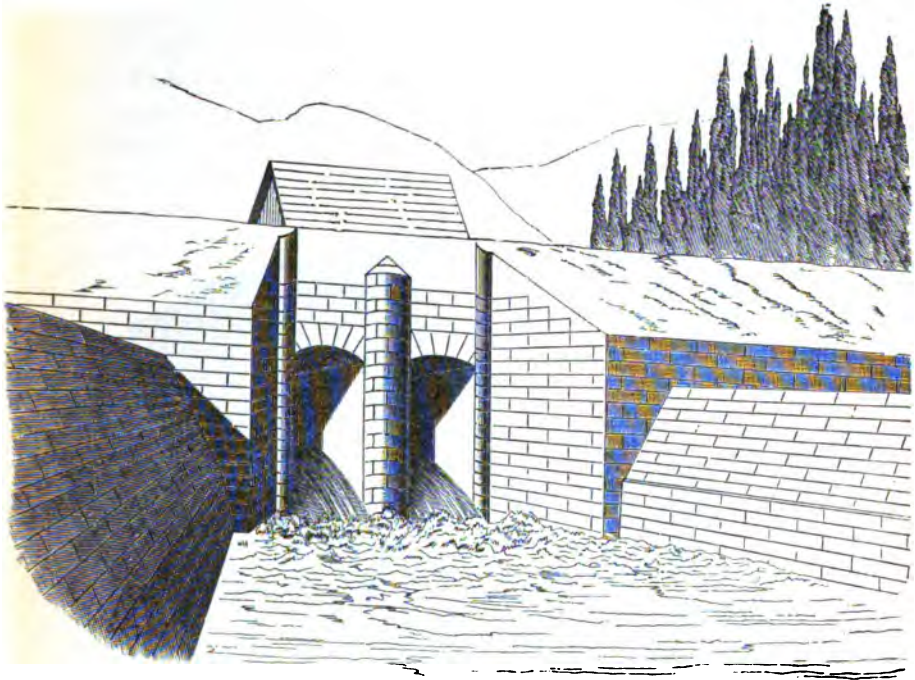
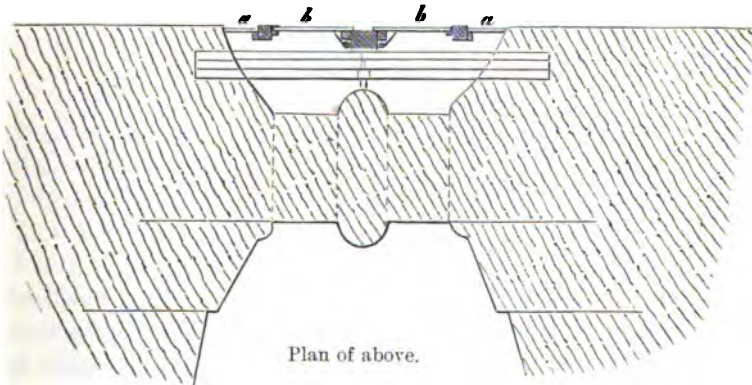

Fig. 233.—Masonry-dam at Herrenwies (Black Forest).



pressure on *b b*. This dam is to be recommended owing to its simple gates and manner of opening them.

(d) Dams of combined masonry and earth.—These are the

most highly perfected of all dams, and are used in the Bavarian forest, as shown in transverse section, in Fig. 234. The masonry rests on a foundation of piles, and the reservoir side of the dam is faced with hewn stones resting on cemented rubble-masonry containing a thin layer of concrete. A wall of cement and clay bounds this structure, and a well-stamped

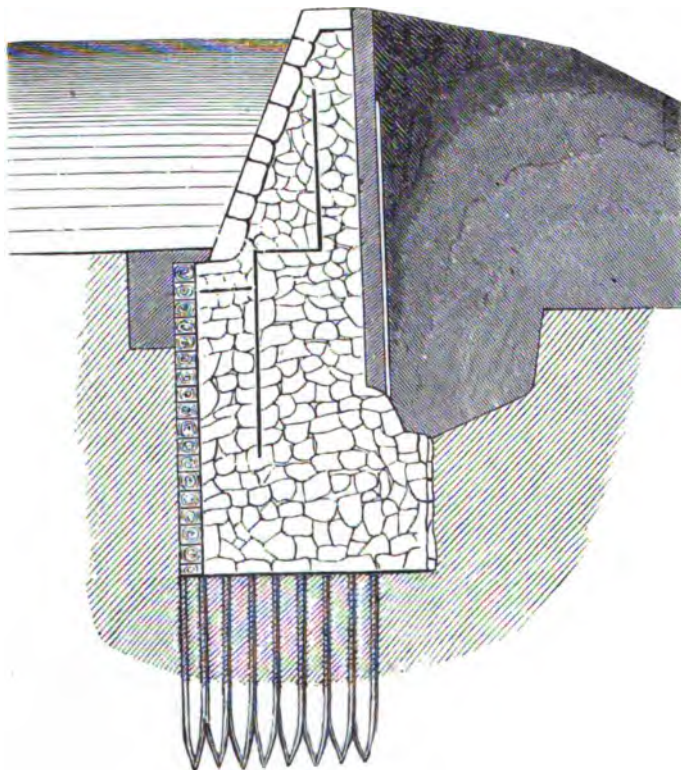

Fig. 234.—Masonry and earthen dam in Bavaria.

earth-dam is continued towards the valley. This mode of construction, and a liberal use of cement and concrete to a considerable depth in the foundations of the dam, make it watertight in the highest possible degree.

(e) **Sluice-gates.**—The gates for the chief outlet of water from the reservoir are usually in the middle of the dam, but sometimes at its base. The sluice-gates open usually into a

channel, which conveys the rush of water at some distance from the dam into the natural bed of the stream. This protects the lower side of the dam from being undermined by the water, and is specially important in the case of wooden sluices and earth-dams, as in Fig. 231, *m b n*. The sluice-gates are closed by various contrivances, and they may be distinguished, according as they open with a rush, like ordinary sluice-gates, or are raised gradually, as in the case of vertically opening valves.

(f) **Sluice-gates opening in the ordinary way.**—This is

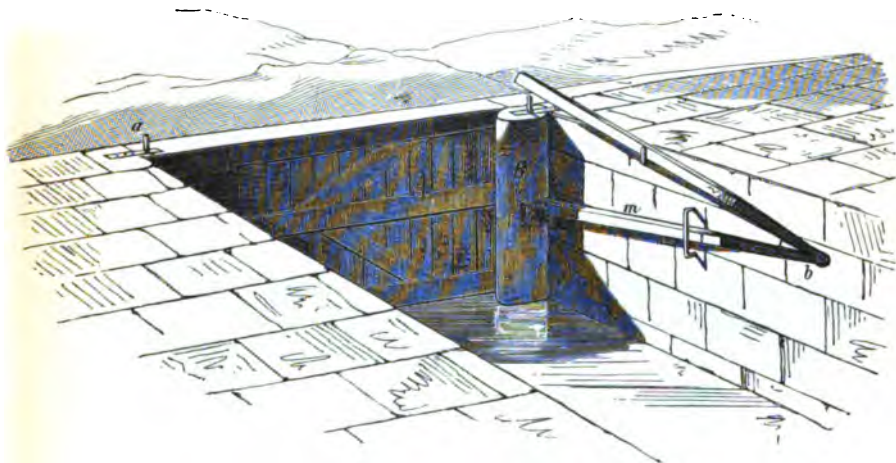

Fig. 235.—Sluice-gate.

effected by means of hinges, but the gates are closed by various contrivances. The usual method of closing them is shown in Fig. 235. *A* is the gate revolving on hinges at *a*. *B* is a revolving elliptical cylinder of wood, which is kept closed by means of a peg (*b*), a lever placed between *b* and the wall of the dam and the pressure of the water in the reservoir, until the lever (*m*) is withdrawn; the pressure on *B* then causes it to revolve on its axis through an angle of 90° and present its smaller diameter to *A*, so that the latter can open, *b* entering a recess in the wall made to receive it.

Another mode of opening a sluice-gate is shown in Fig. 236:

as long as the end (*m*) of the lever (*s d m*) rests against the peg (*b*), the cylinder is kept closed, but when *s* is pressed

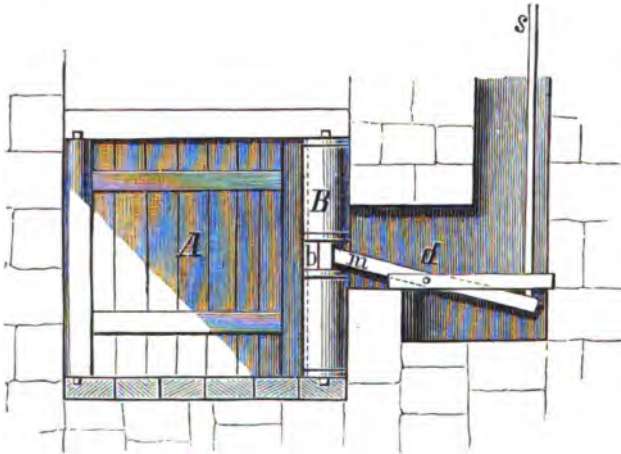

Fig. 236.—Sluice-gate.

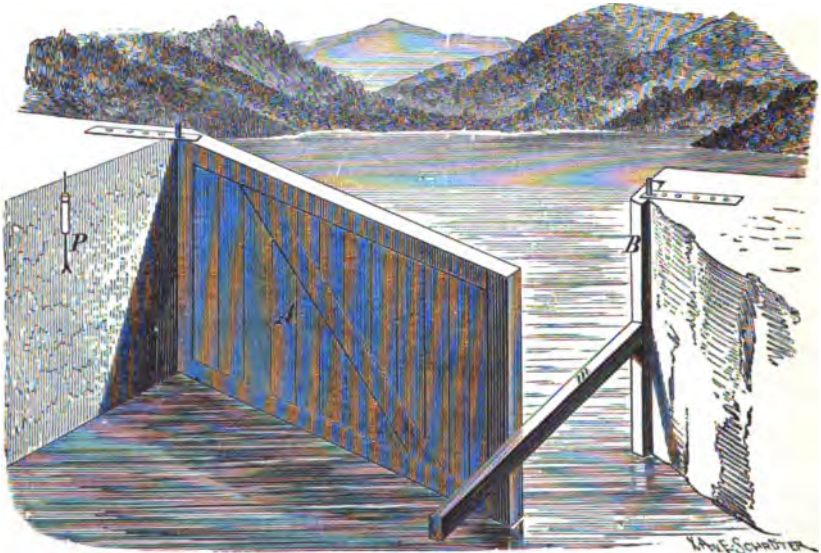

Fig. 237.—Sluice-gate.

down, *b* is released, and the gate opens. This mode of opening is used chiefly when the walls of the dam are high.

Fig. 237 represents another mode of opening sluice-gates, where the bar (*m*) is fastened back by an iron pin which fits through a projecting stone at *P*, and can be easily withdrawn.

[In the case of all the above sluice-gates, there is danger of the gate swinging violently against the wall of the dam, and being broken or injured. This is avoided by having the

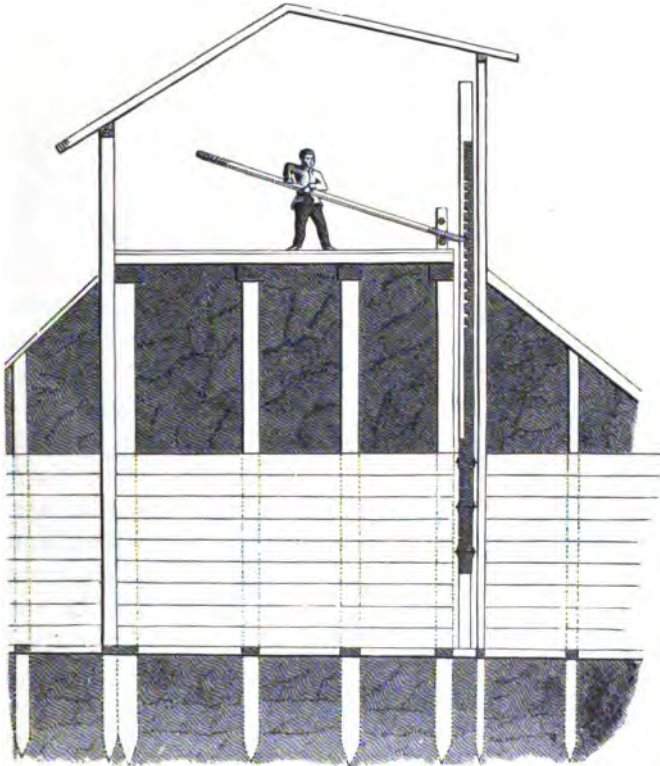

Fig. 238.—Earthen dam with sluice-valve.

hinge at a short distance from the wall, so that when the gate is opened, there may be a passage for the water between the hinge and the wall of the dam; the intervening water then breaks the force with which the sluice-gate swings, and prevents its striking the wall.—Tr.]

It is evident that when the confined water of the reservoir presses with all its weight on the whole sluice-gate, on

opening the latter, the violent rush of water would damage the banks below ; such gates can therefore be used only where the watercourse below has steep rocky banks. They have also the disadvantage, that the sudden rush of water may not be able to carry downstream all the wood which is lying on the

bed of the watercourse, so that much of its effect is lost. In the Tyrol, self-opening sluice-gates are used, which open when the reservoir is full.

(g) **Sluice - valves.** — Sluice - valves are used in well-constructed floating-channels and wherever the banks need protection against the downward rush of water, so that the amount of water passing through the passage in the dam may be regulated at will. These valves are opened by means of a lever fitting into cogs, a ratchet preventing the descent of the valve (Fig. 238). In the Absdach sluice, the so-called ladder sluice-gates are adopted, the construction of which may be seen in Fig. 232. In order to avoid the use of heavy valves, two smaller ones side by side may be used, or several, each of which works in its own groove and may be raised by a revolving axis by

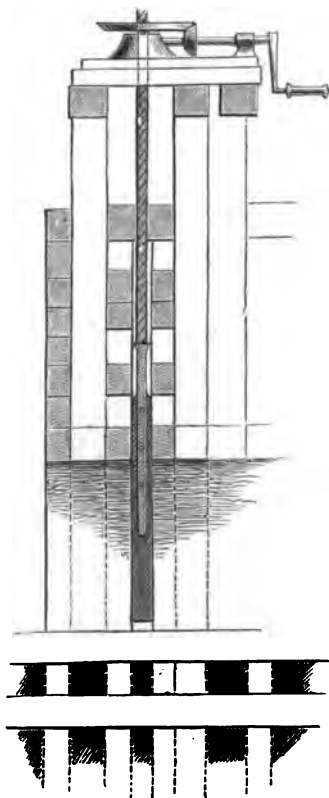

Fig. 239.—Sluice-valve.

means of rollers and chains, or winches.

The mechanism for raising these heavy valves with a small expenditure of strength should be of a very simple nature. Fig. 239 gives a simple combination of cog-wheels and endless screw for the purpose. This mode of raising valves is in general use for the tanks which will be described lower down.

(h) **Sluice-gates made of logs.**—The roughest method adopted for closing sluices is to place a number of round logs, split in half, vertically alongside one another, with their ends resting against two strong beams above and below. The crevices between them are then stopped with moss, and a pile of earth is often made behind them. When it is desired to release the water, a hook attached to a rope is passed through an iron ring in the central log, which, on being lifted, is

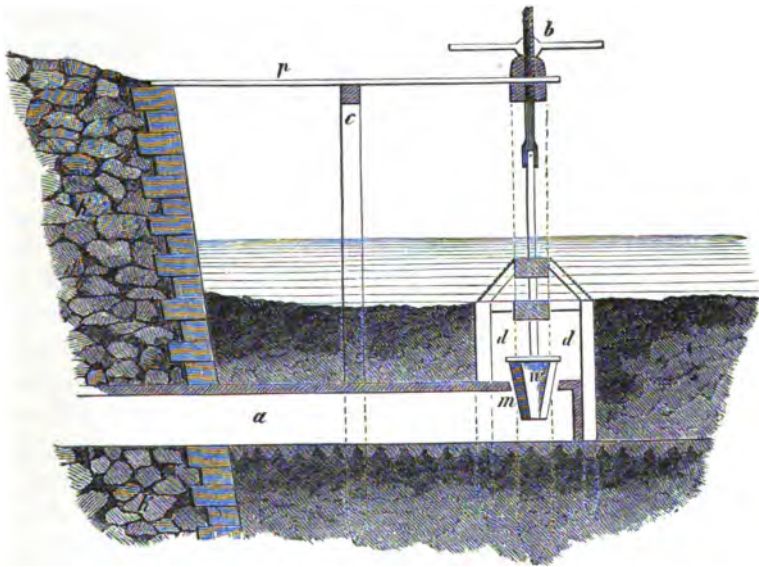

Fig. 240.—Plug-valve.

carried down by the water ; the other logs are similarly lifted out of the way.

Balks of wood one above the other also may be suspended horizontally, as is usual in the Black Forest, by chains before the opening, as shown in Fig. 233. They are raised one after the other by hooked poles. Fig. 240 shows the so-called **plug-valve** which is much used, especially in Austrian Silesia. The valve fits vertically into a channel (*a*) excavated under the dam and projecting 4 or 5 yards into the reservoir, where it is strongly closed, the open end of the channel leading down-stream. The end under the reservoir is open at *m* and

can be closed by a conical plug (*n*) which is raised by means of a vertical bar and screw (*b*); (*p*) is a plank bridge for giving access to *b*. The chamber in which this plug plays is covered with a fine grating to exclude rubbish. This kind of valve weakens the dam much less than any other form of opening for the water, and the water can be allowed to pass through the channel as gradually as one could wish; it is however very liable to become filled with silt and mud, that are removed with difficulty.

All sluice-gates must allow for an overflow of excessive water from the reservoir and also for passing a small quantity of water into the floating-channel before the principal sluice-gates are opened. The principal rush of water, which is required for floating, passes through the sluice-gates, of which there may be several in the case of large dams, but when once the reservoir is full of water, any more water coming in must be allowed to escape, otherwise the top of the dam would be injured. For this purpose, therefore, a small channel is generally provided at the top of the dam, unless there is a special gate constructed for this purpose. It may also be necessary to completely drain the reservoir of water, in case of repairs, or to free it from sand, gravel, etc.; for this purpose a third opening may be necessary lower down than the principal gates. It is usual to admit a little water into the floating-channel so as to set the logs slowly in motion, before the chief rush of the water comes. This can be done at pleasure by means of sluice-valves, but where there are sluice-gates a special opening must be made in the large gate for this purpose, unless the floating-channel is provided with a small quantity of water by a side-channel, opening with its own sluice-gate. The size of the principal sluice-gate depends on whether it serves only for the passage of water, or for the wood as well, and in the latter case it must evidently be 4 or 5 meters broad (Fig. 232).

(i) **Dimensions of Dams.**—Dams vary much in size; there are some dams which maintain reservoirs capable of submerging a whole valley below them; these are 450 feet long, and over 65 feet in breadth, and in their construction a considerable amount of capital is invested, whilst

others can raise the level of a stream barely above its full strength.

The more a watercourse is encumbered with boulders and rocks, the lower the dry-season level of its water and the longer its course, the more plentifully should water be supplied. Sometimes in such cases dams are constructed which allow of a depth of water in the reservoir, at the dam, of 15 to 30 feet. Well-constructed floating channels with a small and uniform fall require much smaller dams.

Generally large reservoirs are preferable to small ones, even though they take a comparatively long time to fill, as their effects are more proportional to their cost, and the floating is more certain than where several small dams are constructed. Very large dams have been made in Carinthia and the southern Alps, and in Austria and Hungary.

(k) **Position of Dams.**—The principal dams are made always in the uppermost parts of a mountain-valley, and their effect reaches for several miles down, so that in many valleys no more dams are required below the principal one. In other cases, however, there are floating-channels with several small dams at distances apart of from $1\frac{1}{2}$ to 2 miles.

Dams are intended, as far as possible, to drive the drainage of a locality into the watercourse which is used for floating. Watercourses, however, contain least water near their sources, but are here most in demand for floating purposes. It is therefore necessary to utilise the first weak run of the water, and wherever it is possible to do so, a strong dam is erected near the very top of a valley, so as to collect as much water above it as possible.

A site is therefore preferable for the principal dam where the sides of the valley approach one another with rocky walls, whilst above this gorge is a basin-shaped expanse of valley. Such places are often found in mountainous regions.

Care must be taken that the water entering a reservoir is fairly free from silt and gravel, which would soon render it too shallow for use. Wherever this is not the case, special works must be constructed to keep out the sand, etc.; these will be described further on, under the heading "Weirs."

iv. *Tanks.*

Dams can be constructed across a stream only in narrow mountain-valleys where they can rest on mountain-spurs on

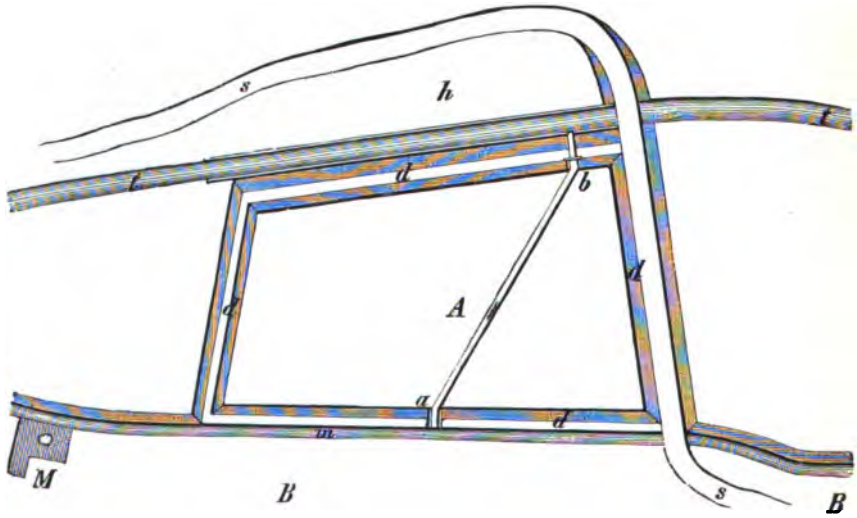

Fig. 241.—Tank *A* supplied by river *t*.

both sides, without being necessarily of any considerable length. In wider and broader valleys with a slight fall,

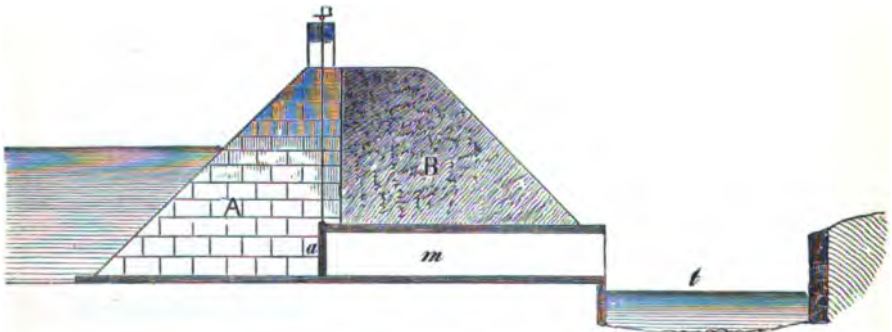

Fig. 242.—Sluice-gate of the tank *A*.

where there are meadows, cultivated lands and perhaps houses, which a dam would obviously inundate, while its cost

would be prohibitive, owing to the large amount of compensation involved, it may, nevertheless, be necessary to obtain larger supplies of water for floating timber than the natural course of a stream affords, and these may be secured by constructing a tank. This is an artificial pond surrounded by strong embankments, that is fed by underground culverts, or by a canal bringing water from the upper part of the watercourse; thus water may be collected in the tank to swell the stream below it.

There may be peculiarities of the locality that modify the mode of construction of tanks, but in this respect they are much less variable than dams.

Figs. 241 and 242 represent a tank which has been constructed at Wilgartswiesen, in the Bavarian Palatinate. The reservoir *A* is situated between the floating-stream *t* and a small mill-stream *m*. It is surrounded by strong embankments (*d, d*), 14 feet high, and is fed by the mill-stream, which bifurcates from the watercourse above the reservoir and is led along the hill-side with a gentle fall, so that at *a* it is about 10 feet higher than the watercourse, which it rejoins after passing the mill *M*. There are sluice-gates at *a* and *b*, the former for admitting the water and the latter for its escape; *s, s* is a cart-road along which is conveyed the wood which is stacked at *h*, and there put into the stream. This tank holds 280,000 cubic feet (8,000 cubic meters) of water, it can be filled once daily, and takes 2 hours and 40 minutes to run dry, floating 42,000 stacked cubic feet (1,200 cubic meters) of firewood.

The embankments of tanks may be of earth or masonry, or half earth, half masonry, as shown in section in Fig. 242. Here *A* represents the stone-masonry, *B* the earth-work, *a* the sluice-valve, *m* the feeder, and *t* the watercourse.

Tanks to assist floating have been constructed at several places in Silesia, Franconia, the Palatinate, etc.; they are utilised in summer for irrigating meadows and cultivated lands.

v. *Weirs.*

The works already described have for their object to increase the quantity of water in a floating-channel, but as soon as the

accumulated water has run off, the stream resumes its natural level.

Weirs, on the contrary, are constructed to raise the water-level permanently and moderate its fall and velocity. They consist of a shallow dam erected across a stream, the top of which is either slightly below, even with or above the water-level, so that the water must more or less increase in depth behind the weir before passing it.

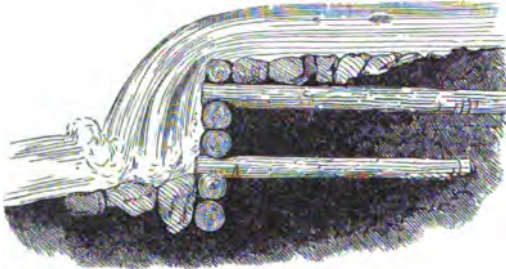

Fig. 243.—Wooden overflow weir.

Thus we may have **ground-weirs**, below the surface of the stream; **overflow weirs**, between the highest and lowest levels of the water, and **sluice-weirs** which are provided with gates: in the latter case, the quantity of water in the stream can be perfectly regulated.

All these three kinds of weirs are employed in streams used

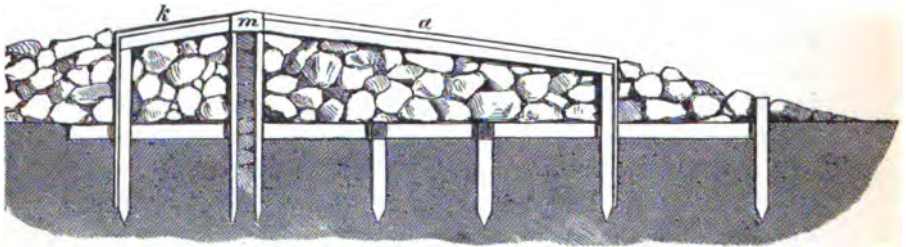

Fig. 244.—Overflow weir with slight fall.

for floating; they are necessary not only to divert water to mills and irrigation-canals, when the water is used for these purposes besides for floating, but also to maintain a high permanent level of water in a floating stream.

The construction of **ground-weirs** is very simple, they may be composed of a ridge of stones, a stem of a tree kept in

position by piles, or row of piles behind which sunken fascines or stones are placed.

An overflow weir may be constructed either of wood or of stone: Fig. 243 shows a section of a simple wooden weir with a steep declivity; Fig. 244, a weir with a slight fall.

Stone-work is naturally preferable to wood in constructing weirs, and wherever coarse stones are available, a weir may be constructed as in Fig. 245. Weirs constructed of hewn

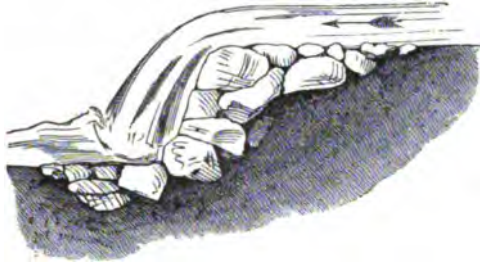

Fig. 245.—Stone overflow weir.

stone-masonry (Fig. 246) are preferable to rough constructions, but unless the watercourse has a rocky bed, piles must be driven in to serve as a foundation under the weir.

The efficacy of any weir is measured by the height to which the water rises behind it, and the distance back to the point

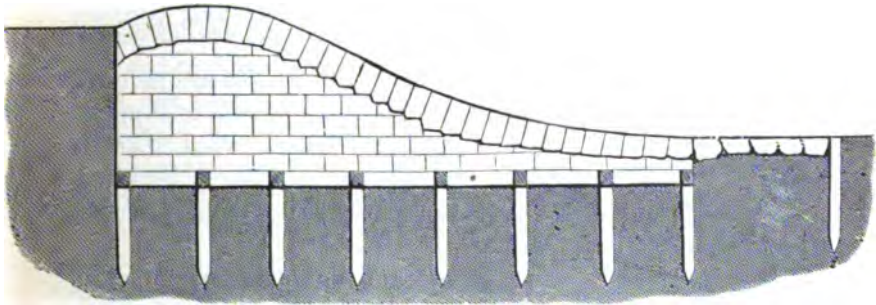

Fig. 246.—Stone weir.

where the stream retains its former velocity, or ceases to be slack-water. Hence, in order to improve thoroughly a stream for floating, a succession of weirs should be constructed from slack-water to slack-water; in this way the average fall of the stream will be reduced, a very important point in floating.

The slower the current, the further back the slack-water extends; in sluggish streams, weirs may reduce the velocity of the stream too much for floating, and are useful only for diverting mill-streams from the main watercourse. Wherever, on the other hand, the current is rapid, it is evidently advantageous to keep the water back as much as possible; for then, independently of the advantages of a moderate current, the banks and works to improve the floating are secured much better against erosion, and the depth of the stream is rendered much more suitable for floating, an important matter when it contains much gravel and boulders.

The most suitable places for weirs are narrow valleys between rocky banks, as in such places the water cannot damage the banks of the channel and cause inundations, even when its depth is considerably increased.

In such places generally several consecutive weirs are required, so that the watercourse in certain cases becomes regularly terraced, with a succession of falls. As a rule, the number of weirs should be proportional to the rapidity of the current and the quantity of gravel and boulders in the stream. These weirs are not constructed all at the same time, but by degrees, as the space between any two of them becomes filled with silt and gravel, and therefore a new weir becomes necessary.

Besides the above-mentioned weirs, others also are required wherever any side-channel leaves the main stream to supply a mill, etc. Booms for collecting the floating wood also are erected frequently on weirs. The more remote the point where the water from a side-channel is required, the higher must be the weir which supplies it.

It is evident that sand, gravel and boulders accumulating behind the weirs constantly raise the bed of the stream, so that the water will in time overflow its banks unless they are sufficiently high. This is dangerous not only for the banks, but also for the wood which is being floated and tends to leave the stream and become stranded. If then a rush of high water follows, much damage may be done to the riparian properties, for which the manager of the floating will be held responsible unless he has taken proper precautions. In all cases,

therefore, where such damage is to be feared, weirs should be furnished with sluice-gates, which may be opened when there is danger of a flood.

Fig. 247 shows a section through the middle of a weir in which a sluice-gate is supplied, $m o n$ being the section of the weir, and $o m$ the sluice-gate with a sloping base ($s m$), enclosed by wooden horizontal walls; this gate is closed when the water-level is at its ordinary height, but can be opened in floods.

More frequently, however, a ground-weir is erected with a number of sluice-gates arranged side by side, by opening

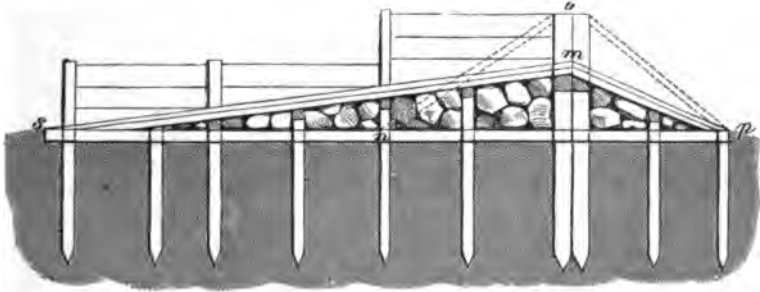

Fig. 247.—Weir with sluice-gates.

which all the water may pass in high floods or the timber be allowed to float through.

It has been remarked already that certain works may be necessary to keep silt, gravel or boulders out of reservoirs; these works are merely weirs made of wattle-work or stone, across the small brooks which feed the reservoir, and thus the results of denudation of the hill-sides are kept from descending the watercourse. In addition to these weirs, the ordinary measures should be adopted for fixing the slopes on either side of a mountain-torrent, and keeping it stocked with forest growth.

(b) Works for regulating the Course of a Natural Stream.

There is not a single watercourse, which is naturally so suitable for floating timber, but that it may be improved by some

artificial works, to render the floating more regular and to avoid damage. In strong or weak waters there are always a number of hindrances: the banks may require securing; it may be necessary to remove obstructions from the bed of the stream, by blasting, or otherwise; sometimes the current requires modifying, or bifurcations of the stream should be cut off whilst floating is in progress.

i. *Strengthening the Banks of Streams.*

Artificial works may be employed with advantage wherever the banks of a stream are too steep, or too sloping, or where

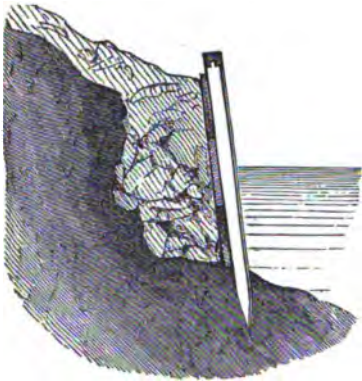

Fig. 248.

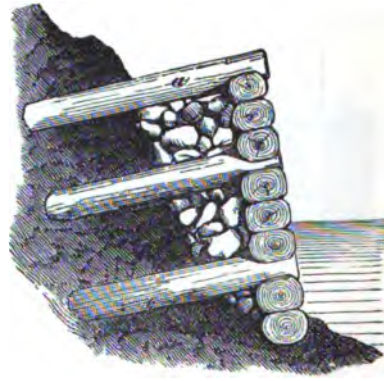

Fig. 249.

Methods of strengthening the river bank.

the breadth of the stream requires modification. **High, steep or vertical banks** of a stream, if not of hard rock, get undermined and fall in, holes being formed in which the wood sticks; or the material of the bank may be carried away and form an obstruction lower down the stream. Wood which lodges against the bank becomes at length waterlogged, and may be lost. Hence, all bad banks require facing. Wherever the bank is composed of mere earth, a slope of 25 to 30 degrees should be given to it, and it should be sodded or planted with willow-cuttings to give it firmness. If a current sets in against such banks they may be protected by wattle-work, a trench being dug along the bank, a wattle-work fence

constructed and the interval then refilled with earth well rammed-in. The earth bank may also be faced with ordinary stone-masonry, or merely with large dry stones, and the trench filled with broken stones or gravel. Where stones are scarce, fascines may be laid parallel to the bank, secured by means of stakes, and covered alternately with stones or earth.

Other modes of protecting banks consist in a row of piles, which are driven-in in front of the place to be protected, and either bound with wattle-work, or planks or fascines fastened on inside them (Fig. 248). Where wood is plentiful the walls may be of logs 4 to 6 inches thick (Fig. 249), supported by stakes (*a*), and nailed together with long iron nails. It is, however, always better to employ stone-masonry for the purpose wherever stone is procurable, both to economise timber, and because the latter is not durable. Where stone is used for the purpose a good foundation must be supplied, as in Fig. 250, to prevent undermining, and a slope of about one in ten should be given.

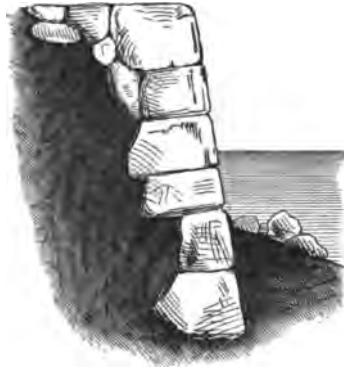

Fig. 250.—Stone-facing.

As great a hindrance to floating as steep banks, are banks which are too flat, as the stream widens-out in such places, and tends to fall-off in strength, depth, and rate of current. The gravel and other material brought down from above accumulate in such places, forming shoals which the floating timber only passes with difficulty, and many logs become stranded. Improvements thus have for their object to restrict the bed of the stream.

The simplest method is to drive in a double row of piles as close to one another as the length of the logs which are floated, they demarcate the stronger water from the slack-water near either bank. The piles are high enough to overtop the highest level attainable by the water, and the logs as they float down align the piles and exclude the dead water.

In some cases wattle-work is applied round the piles, other rows of piles are driven-in a few feet from the first rows, and the interval filled with stones, branches and sand. Finally solid parallel lines of masonry may be constructed, which are no other than dams running parallel to the stream and united to the old banks by wings; they may be looked upon as artificial banks to the stream.

The top of these dams must be of about the average level of the stream so that all flood-water passes over it, carrying with it silt and gravel which gradually fills-up the site of the slack-water. Sometimes where there is an extensive tract of slack-water, it may be covered with a network of dams crossing one another, which gets filled with silt, etc.; if these dams are raised gradually as the spaces between them become filled, the slack-water may disappear entirely, and the lateral dams be overflowed no longer at high water.

ii. Strengthening the Bed of the Stream.

The bed of a stream requires artificial improvement much less frequently than the banks. This is, however, sometimes requisite, in the case of **mountain-torrents with stony beds**, and usually consists in **blasting-away the rocks and removing stones**, which otherwise might cause holes to form behind them in the bed of the stream, and thus catch the floating logs. The best season for these operations is the autumn, or whenever the water is lowest; the stones removed from the stream may be utilised to improve its banks. It is, however, easy to do too much in the way of removing obstacles from the bed of a rapid stream: for if a floating-channel be freed from all impeding rocks and stones, which form so many natural weirs in its course, the stream often becomes torrential and its banks may be broken and inundations or other disastrous consequences ensue.

Rapids may occur where the bed of a channel is narrow and steep, where the stream runs between rocks in passing from a higher stage in the valley to a lower one, and there is then likely to be difficulty in floating the timber. If in such places the bed be terraced (Fig. 251), floating will be much expedited

by making a network of logs which is filled in with stones. The blasting necessary in such a place is, however, so difficult to carry-out, that frequently the wood is landed and passed down a water-slide and placed again in the stream further on.

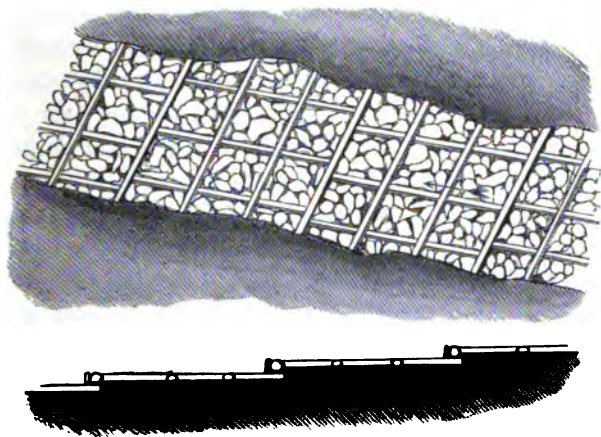

Fig. 251.—Fixing the bed of a stream.

Careful paving of the bed of a stream is not unfrequent at openings from tanks and to a certain distance inside the latter.

iii. *Rectifying the Floating Channel.*

Usually the channel of a mountain-stream winds considerably as soon as it approaches the plain, and its current is thus reduced considerably. The wood, which is being floated, has therefore to travel far in order to pass over a comparatively short distance, and may become water-logged. Owing to the slight fall, inundations occur with every high water, the banks of the stream are injured and much wood stranded far and wide.

Straightening the channel of the stream is then the best mode of obviating these dangers. The stream is straightened by making short artificial cuts between its bends and windings. Such a cut is commenced generally at several places between the points on the stream that are to be joined, the banks then serve as dams until the channel is completed. In such

cases it may be even worth while to make tunnels for the water to pass, as at Hals, near Passau.

Artificial floating-canals leading to a timber-depot are of the same nature as the above and sometimes run from one river-basin into another.

The best known of these artificial floating-canals is that belonging to the Prince of Schwartzenberg, at Krummau, in Bohemia ; it is 35 miles long, of which 600 yards are tunnels leading from the centre of the forests to the river Mùhel, which flows into the Danube between Lintz and Passau and brings down the yield of 35,000 acres of forest.

Whenever a canal is dug, levels must be taken most carefully beforehand ; one in fifty is the best fall, though frequently unattainable. The canal just described has a fall of one in nine for a short distance, and one in the Bavarian forest a fall of one in five. In such places, the bed of the canal must be paved, or terraced, as already described.

In the latter case, the upper section of the canal is only 4 to 5½ feet broad, and 1½ feet deep ; it brings down very large butts for the saw-mills. It is there constructed of blocks of granite ; lower down, its banks are made of wood, but in 1882 the floods proved too much for these wooden constructions. In the lowest section, where there is much more water available, the width of the canal is 10 feet.

In constructing such canals the chief point is to secure a good supply of water, owing to the snowfall in mountainous regions this can generally be done. The line is then taken, as far as possible, through all adjoining mountain-streams, or it is supplied with water by reservoirs and dams.

iv. *Lateral Booms.*

All streams used for floating have branches either natural or artificial, and arrangements must be made to keep the wood out of such bifurcations, or in certain cases to conduct it into a side-stream. To effect this, lateral booms either floating, or fixed in the bed of the stream, are required. A thoroughly dried spruce-log fastened to the bank of the stream by withes and floating in the water in front of the side-stream will often suffice.

Should the width of the stream be so great that this is not sufficient, a chain of two or more logs (Fig. 252) attached together either by withes or iron rings may be substituted. These are floating booms. Whenever a boom has to withstand a great pressure, as, for instance, where numbers of saw-mill butts are being floated, or the floating wood is being driven from the main stream into a bifurcation, a fixed boom (Fig. 253) should be constructed. In this case, piles (*m m*) are driven into the bed of the stream and are supported by props (*s s*).

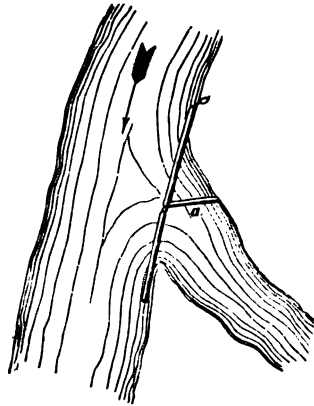

Fig. 252.—A lateral floating boom.

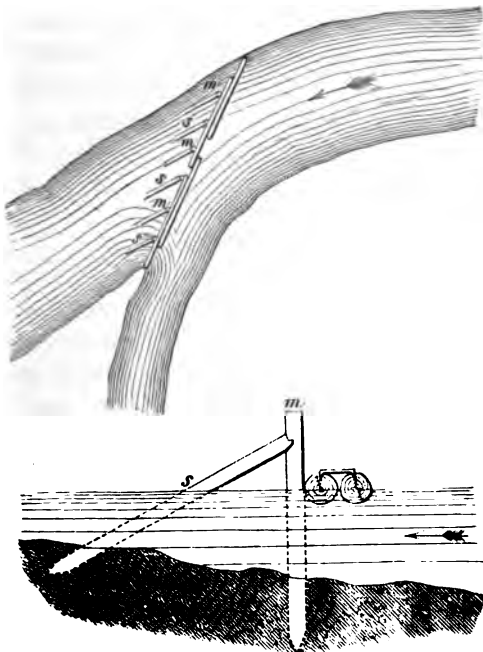

Fig 253.—Fixed lateral boom.

The logs forming the boom are then attached to these piles and close the stream. One row of logs is often insufficient, and then two or more logs are fastened together and placed in front of the piles. Such booms will not, however, stop water-logged wood; when there is much of this, a more elaborate boom is required, the construction of which will be described further on.

v. Accessibility of the Banks of the Stream.

Accessibility of the banks is another necessity whenever a stream is used for floating timber. The water must be accessible at least from one of the banks by a good foot-path, so that the workmen may be able to fasten logs to the shore, push off stranded logs, or land timber, and move about expeditiously.

The only difficulty in lower mountain-valleys and level ground is to come to terms with the riparian owners about sites for the construction of booms, etc. In the higher mountain passes, however, steep precipices often line the banks of narrow gorges, through which the stream passes, and the logs can be controlled by the workmen only at great risk to their lives. Such gorges are especially common among limestone rocks; they form passes between the higher and lower stages of the valleys, the water falling in a series of cascades among large boulders and masses of rock. The floating wood is constantly sticking in such places, and a whole sweep of timber may thus be stopped. In order to prevent this mischance the gorges must be made passable; often a pathway is constructed with wooden galleries supported by numerous iron bars and wooden beams let into the rock, and connected with one another by steps cut in the rocks, and by ladders.

3. Booms.

Booms are constructions intended to arrest or divert the passage of all floating wood at a fixed point in a stream. All floating timber is stopped or diverted by the boom, and where large sweeps of timber come down, the boom has to resist considerable pressure and must be very strongly constructed; its site also should be situated favourably for the purpose in view.

Booms, therefore, vary from those of the simplest nature to colossal structures costing thousands of pounds. Most of these booms are constructed by ordinary woodcutters or floaters, who from long experience in the work frequently show great ingenuity; some of them may even be classed as engineers.

But for the very reason that the nature of booms depends on local conditions, no constructions are more varied, and hardly any two booms are alike. In the following paragraphs,

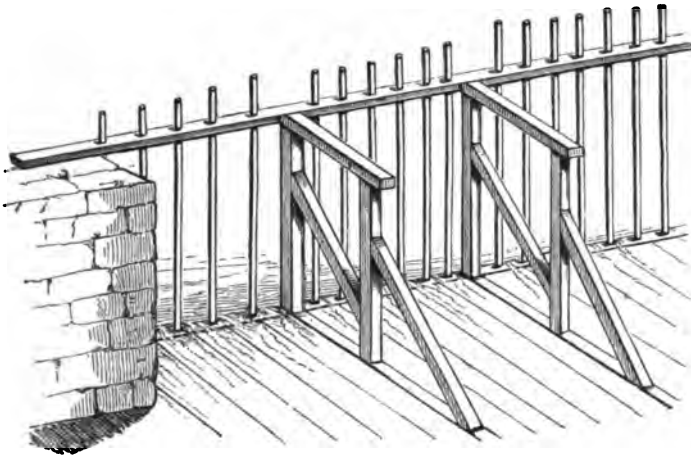

Fig. 254.—Wooden grating to serve as a boom.

therefore, some characteristic forms of booms only will be considered.

(a) **Mode of construction.**—There are three essential points

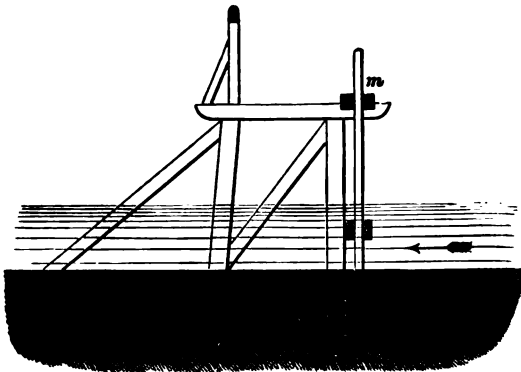

Fig. 255.—Transverse section of above.

in the construction of a boom: the supports, the horizontal bars which stop the sweeps of timber, and the grating of rails that surmounts the boom.

Booms may be divided into two classes, according as the grating is vertical or oblique, the largest and most important belonging to the latter category.

Fig. 254 represents a simple form of wooden boom with a vertical grating which has to resist a moderate pressure only; Fig. 255 shows the section of a support to this boom, and *m* the grating and horizontal bars. Wherever in mountain-streams rocks occur on which the grating may be supported, they may be utilised as supporting piles for the boom; but if such natural supports are wanting and the pressure of the

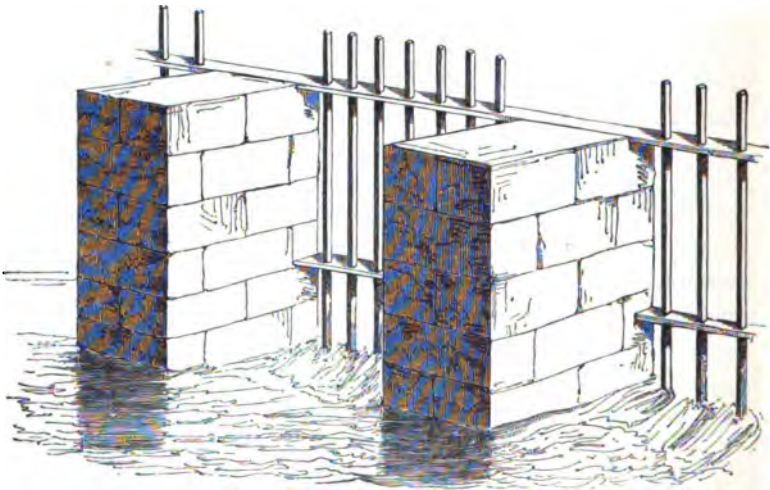

Fig. 256.—Boom with stone supports.

sweeps of timber is great, masonry-pillars must be erected for the purpose (Fig. 256).

The horizontal bars are constructed of large balks of timber, which are bored through in order to allow the rails of the grating to be inserted; or they are composed of three balks, the middle one perforated to support the grating. The lower bar is placed frequently at the water-level (Fig. 254), where it is best preserved.

In the case of large booms required to withstand the pressure of large sweeps of floating wood and powerful streams, oblique gratings are used. It is evident that such an

arrangement will withstand a much greater pressure than will vertical gratings. The inclination of the grating to the surface of the water varies, depending on the absolute weight and

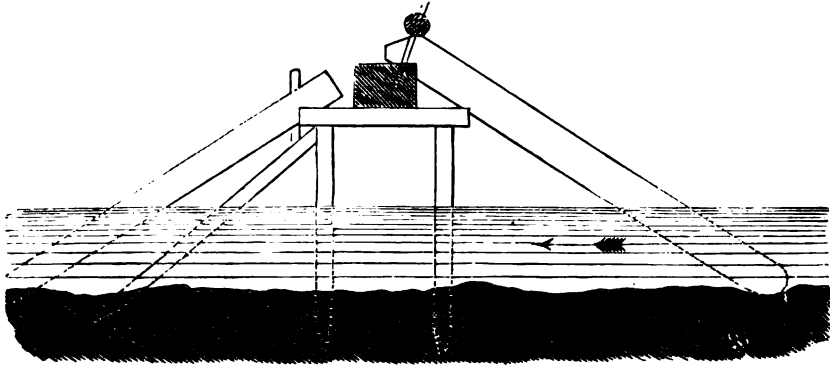

Fig. 257.—Support of an oblique boom.

stability of the rails which form the grating. Where these rails are large—in large booms they often attain lengths of 20 to 25 feet and a thickness below of 8 to 10 inches—the inclination

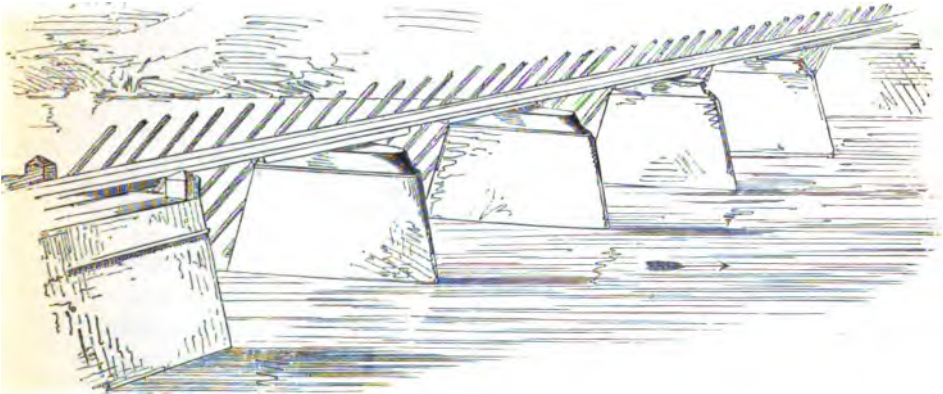

Fig. 258.—Oblique boom with masonry supports.

of the grating may be 60 degrees, but otherwise it is placed more obliquely, say, at an angle of 25 to 30 degrees.

The rails of the grating are always round pieces, barked spruce or larch, with their thicker ends in the water, and they

rest without any support on the bed of the stream. In front of them, floating spruce stems are placed to take the shock of the floating wood from the grating. Where the stream is broad and the grating long, supports are also necessary, their simplest mode of construction being shown in Fig. 257.

The supports of large booms require, above all, a solid foundation: in the case of wooden supports, piles are driven

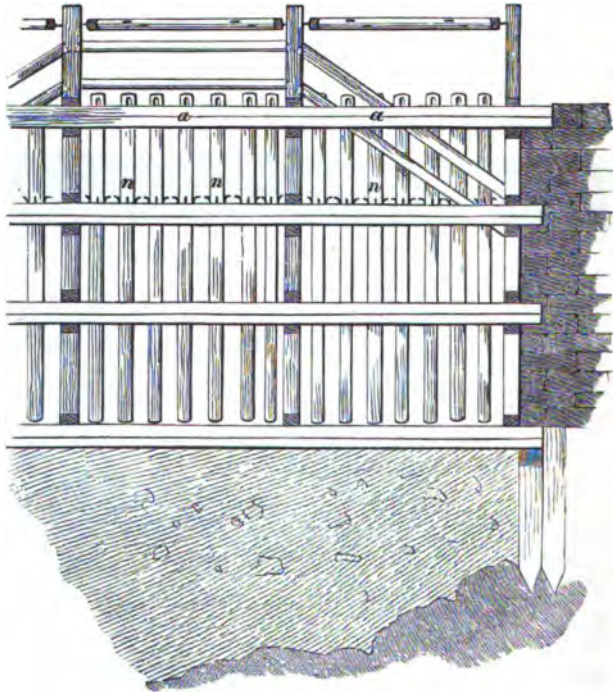

Fig. 259.—Boom with removable grating.

sufficiently deep into the firm (rocky) bed of the stream; when there are masonry-supports, a firm foundation of piles is supplied, in case a rocky base cannot be reached. Fig. 258 represents a large boom over the river Regen, at Regensburg; in this and other large booms the supports are similar to those used for large bridges, they are arranged with their longest sides parallel to the stream so as to offer as little resistance to it as possible. Of a similar construction is the large boom at

Baden, near Vienna, also that over the Ilz at Passau, the boom nearly a kilometer ($\frac{5}{8}$ mile) long at Brixlegg, and other large booms.

What enormous pressure such booms have to support, especially in floods, may be imagined easily from the fact, that floating timber often accumulates behind them to a height of 15 to 20 feet and sometimes even overtops them. In such cases, as has been already remarked, not only must the construction of the boom be of the strongest possible

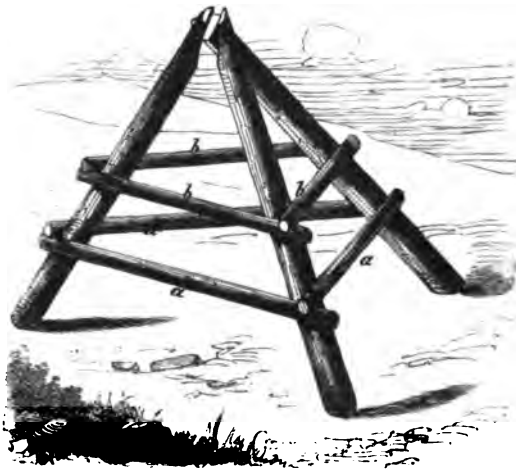

Fig. 260.—Trestle to support a grating.

character, but also the locality must be specially adapted for it.

In the case of many booms, with either vertical or oblique gratings, the latter are placed *in situ* only during the floating season, and for the rest of the year are removed and kept in sheds on the river-banks. This cannot be done always, when the grating rails are very large and weigh several hundred-weights each, but even then, part of the grating must be removed if the stream is to remain navigable, or passable by rafts of wood. In such cases, the rails are provided with strong iron rings so that they can be raised by means of hooked poles and placed on the horizontal bars, and on a planked footway constructed behind the latter.

Water-sawmills always require booms to keep out the floating wood which is intended to pass beyond them. Such booms

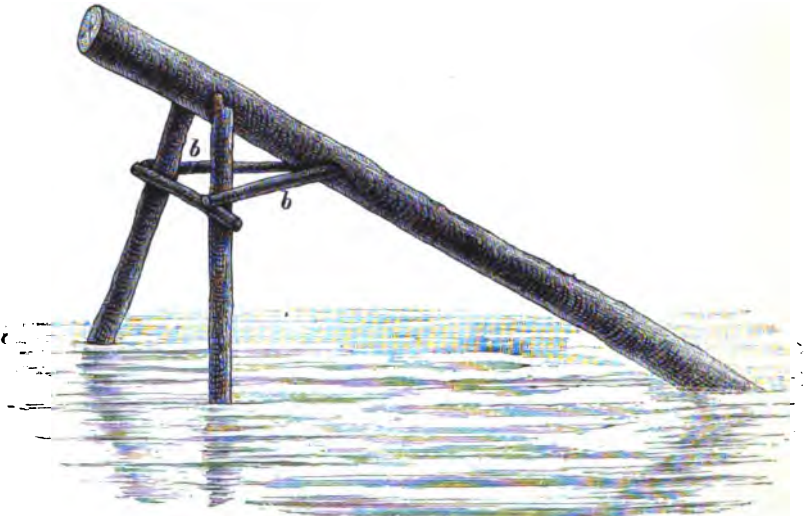

Fig. 261.—Trestle for a boom.

must be constructed so that part of the grating may be readily removable and allow entrance for the butts which are to be

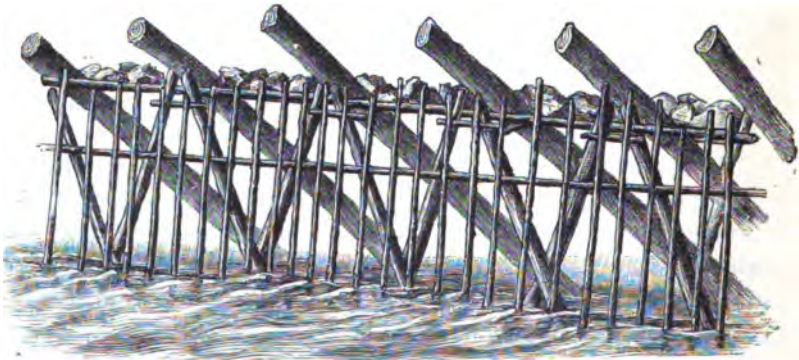

Fig. 262.—Trestle boom.

sawn. The grating is, therefore, frequently provided with the arrangement shown in Fig. 259. The hooks at *nn* are for the removal of the rails, each of which is perforated for

the admission of a wedge to keep it in position when raised, the wedges resting on the bar (*a a*).

Besides the above usual kinds of booms, special, local booms, such as **trestle-booms**, **portable booms** and **booms with gabions**, are in use, of a cheaper and simpler mode of construction. They are used chiefly for temporary floating, or in the case of streams subject to such high floods that the construction of more elaborate and expensive booms is not advisable. They

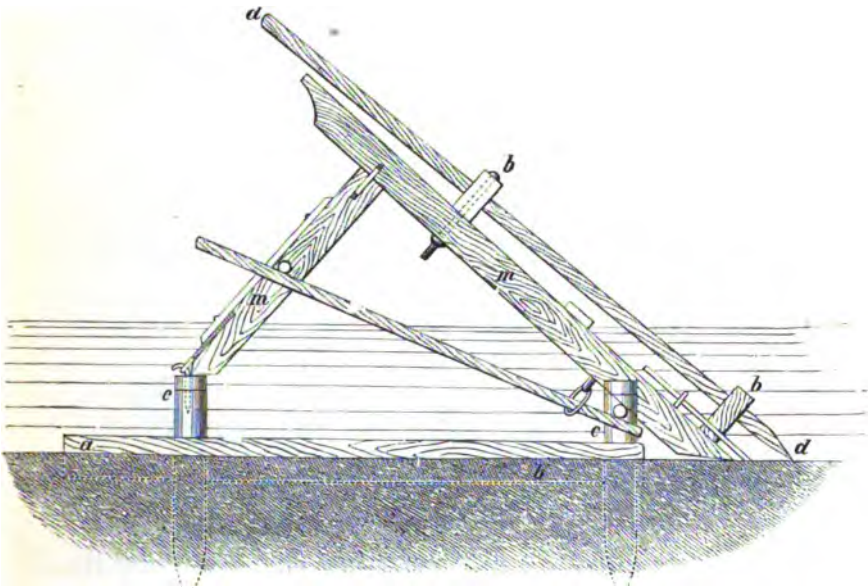

Fig. 263.—Moveable support for booms.

are therefore re-made every floating season, and then broken-up, and are prevalent chiefly on the south side of the Alps, in Savoy, the South Tyrol, Carinthia and other districts.

The essential feature of a **trestle-boom** is a three-legged trestle (Fig. 260). These trestles, strengthened by the transverse pieces (*a a*), are placed in a line across the stream so that one foot of each projects somewhat over the foot of the trestle next to it, and the tops of all the trestles are about the same height above water-level. Thus different-sized trestles are required according to the depth of the water. In the case of large trestle-booms over strong streams, a second row of

trestles is placed behind the first to strengthen it, one of the feet of the second row crossing the feet of those in the front row. This crossing of the feet of the trestles strengthens the boom in a very marked way.

After all the trestles are in position in the water, the bars (*b b b*) are nailed on to them; they are intended to support heavy logs with which the trestles are loaded, to add weight to the boom and render it firmer. As the trestles are not imbedded in the ground, but only rest on it, they would not withstand the force of the stream if they were not heavily weighted. Further weight is added by placing stones

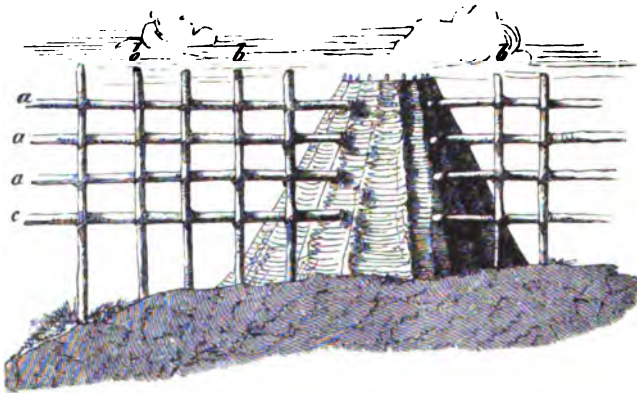

Fig. 264.—Gabion boom.

and boulders above the logs which rest on *b b b*. Supports for the rails are then nailed on to the trestles, the rails fastened to them with withes, and floating logs placed in front of the rails. Fig. 262 represents a form of trestle-boom common in S. Alpine countries.

Portable booms form another class which may be erected and removed at pleasure, but their mode of construction varies considerably. Fig. 263 represents a section of such a boom with a permanent base, which is used in streams where sudden floods occur, as in Lower Austria, the rivers Ziller, Gail, etc. The fixed base is composed of a beam (*a*) and piles (*c c*); on the latter the trestle-beams (*m m*) rest, and the grating-rails (*d d*) are supported by pieces (*b b*) which are bolted to *m*. Another kind of portable boom is used in Nadworna, in

Galiccia, in which three twisted wire ropes are stretched as tightly as possible one above the other and supported by trestles at distances of 30 feet apart.

Another kind of boom is formed of gabions (Fig. 264), as used in Venezianisch and other places. Here, instead of wooden or stone pillars, gabions of basket-work filled with stones are used, which support the horizontal bars and the grating-rails. The gabions are placed in a line across the stream at distances of 5 to 15 meters (16 to 48 feet) apart, according to the strength of the stream, and are tall enough to be above the highest water-level; their height varies, therefore, with the depth of the water in which they are placed. Planks are then placed from gabion to gabion, forming a footway, and stout poles (*a a a*) are bound to the gabions by means of withes. The grating-rails (*b b*) are then bound to *c* outside the water and let down into it from the footway, till each rail rests on the bottom of the river. The several rails are bound by withes to *a a a*, and along the grating floating logs are placed.

These gabions have the advantage of costing little, of being erected in a short time by the floating-gang and of being repaired easily. At the same time, they are not durable, and are often overthrown by heavy floods, to which they offer a large, exposed surface. They are adapted specially for small temporary sweeps of floating timber, chiefly on unimproved mountain-torrents.

Finally, floating booms must be mentioned. They consist for the most part of spruce-logs which are united at their ends by iron rings and fastened together in sufficiently long chains. These chains of logs are fastened at one or both ends, and float on the surface of slowly flowing streams, on which floating is done only occasionally. In order to give them a greater power of resistance, some of the logs are anchored to the bottom of the river. In spite of this, however, they cannot resist a sudden flood, as has been often experienced, in the breaking of such booms, especially if the stream is fairly strong (the river Inn).

[In the river Jumna, at Daghpathar, a boom is placed at a point where the river is 120 yards broad. It consists of two

portions, a raft 354 feet long, constructed of railway-sleepers as shown in Fig. 265, and a line of logs. The raft is fixed at one end to a rock on the right-hand side of the river, and kept obliquely inclined towards the current by wire ropes anchored to the other bank. This portion of the boom is placed in the full current of the powerful stream. From its other end extends a line of logs fastened end to end by a wire rope, and 910 feet long. The floating sleepers are stopped by the raft-boom, and then float along the line of logs into slack-water, when they are

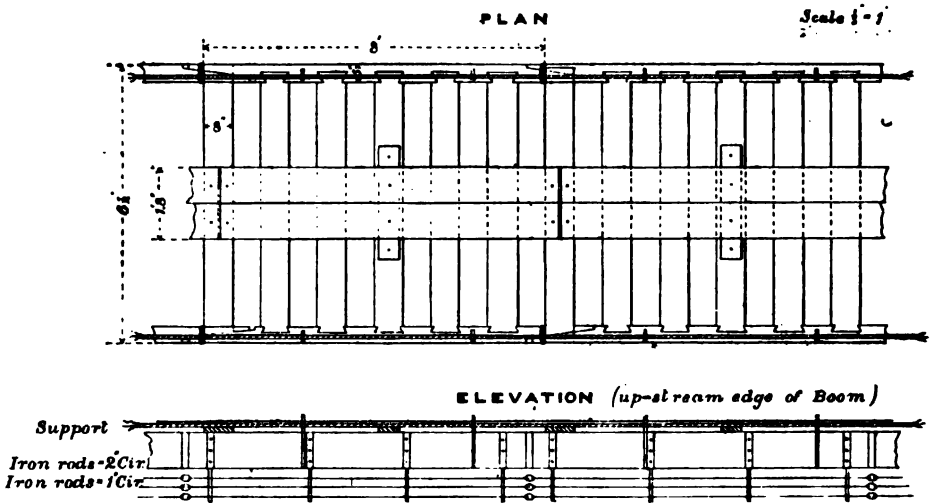

Fig. 265.—Dagpathar boom.

Drawn by A. G. Hobart-Hampden.

caught easily by men swimming on inflated buffalo-skins, and landed.

The construction of the raft-boom is as follows :—

Two broad-gauge sleepers are placed $6\frac{1}{2}$ feet apart and with their broad face vertically downwards; transversely to these and dovetailed or merely let-in, are placed at intervals of about one foot meter-gauge sleepers with the broad face horizontal. In the centre are two planks placed longitudinally and serving as a footway. A wire rope runs along each side, and is firmly fixed to the broad-gauge sleepers. This is to give the boom flexibility against sudden strains. Below the sleepers

are three iron rods one inch in girth supported by bars 2 inches in girth from the broad-gauge sleepers.

This boom cost Rs. 1150, including Rs. 500 for wire ropes, which last for many years; it is annually removed before the July monsoon, and replaced in October. About 400,000 sleepers and scantling are stopped by it annually and made-up into rafts at Dagpathar.—Tr.]

(b) **Modes of using Booms.**—According to the strength of the stream, the purpose for which they are erected, but above all on account of their suitability for any particular locality, various kinds of booms are used. Here, in the first place, a distinction must be made according as the booms are used, either to stop all the wood floating in a stream (**terminal booms**), or to divert it into a side-channel (**lateral booms**); it must be considered, secondly, what steps may be taken to reduce the pressure on booms and prevent them from breaking.

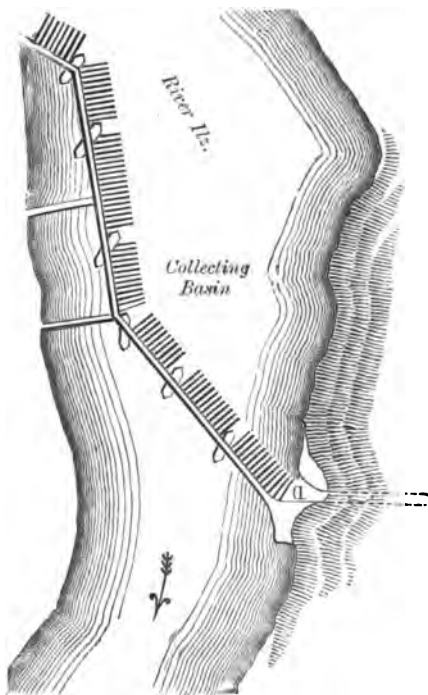

Fig. 266.—Terminal boom at Passau.

i. *Terminal Booms.*

Terminal booms, intended to stop all the wood floating in a stream, are erected either **transversely** or **obliquely** across a stream, the former being termed **straight** and the latter **oblique booms**. Booms may run in a broken line, or be arranged so that a quantity of floating wood may be collected and taken away from the boom.

Straight booms are made chiefly on streams with a slight

fall and where sudden floods are not to be feared. They have to resist severe pressure, and wherever large sweeps of wood are floated should be constructed strongly.

Oblique booms are commoner both in the case of lateral and terminal booms, they have naturally a greater length in proportion to the breadth of the stream than straight booms, and the longer they are, the better able are they to withstand the pressure of the floating wood and floods. Most booms are not straight, but have a broken line of contour; and many booms, and some of the most important ones, collect and retain for some time a large quantity of the floating wood. The boom across the river Ilz, near Passau, built as in Fig. 258, and a plan of which is given in Fig. 266, collects over ten thousand saw-mill butts, and allows for their being continually removed by the underground channel (*a*).

ii. *Lateral Booms.*

These booms are intended to divert floating timber into a side-channel, and are long and oblique.

In powerful floating-channels, a terminal boom usually cannot be laid across the main stream without danger of being broken. In such cases, therefore, a side-channel is diverted from the main stream and the sweep of timber conducted into it, the main stream being barred by a boom. Fig. 267 is a long lateral boom, only closed in the middle by floating logs. *H* is the main stream; *s*, the side-channel, lower down in which the terminal boom is placed; *b* is a weir diverting water into *s*. As in this case the pressure of the sweep of wood and of the stream is divided between two booms, neither of them need be very strongly constructed. This is the chief advantage of leading the floating wood into a side-channel. Where a natural bifurcation of a river does not exist, an artificial side-channel is constructed frequently with advantage; if, then, the lateral boom is supplied with a strong weir, or, if possible, with a sluice-weir, the supply of water to the side-channel may be regulated at will. On this general principle are founded all the better kinds of riverside sawmill timber-depots, which will be described further on.

By supplying booms with sluice-gates, they may be improved considerably; but this necessarily pre-supposes sufficient strength to withstand the pressure of the wood and water. Sluice-gates are specially valuable in the case of large booms with masonry supports. By regulating the supply of water, the front of the boom may be covered more uniformly with floating wood, so that when the sluices are opened the greater part of it may become stranded, or can be brought to land easily. In the case of long booms, it is highly advantageous, by opening first one sluice-gate and then another, to drive the wood in front of portions of the boom hitherto free from it; and, finally, by opening all the sluice-gates to bring in the tail of the sweep of the wood.

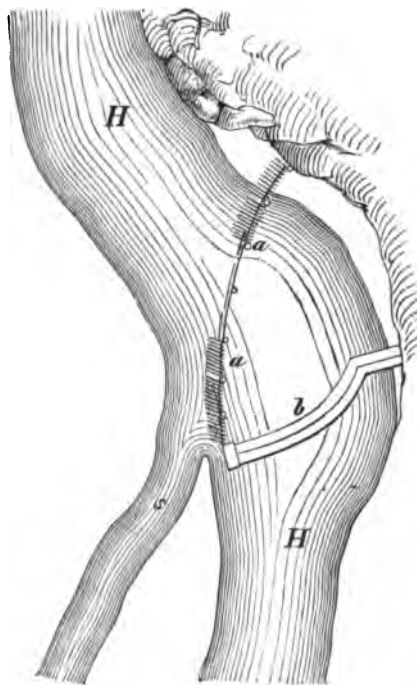

Fig. 267.—Lateral boom.

iii. *Reduction of the Pressure on a Boom.*

Attempts should be made in every possible way to reduce the pressure on a boom; this object may be secured in various ways, by constructing booms on weirs, by means of channels for waste water, channels to remove sand, sluice-gates, etc.

Generally lateral booms are placed on a weir, which supports part of the water-pressure and reduces the fall of the stream and the pressure on the boom. Nearly all large booms which are intended to strand the wood, or to serve as lateral booms,

are of this nature. Channels for waste water are artificial cuts, which branch-off from the main stream above the boom, returning into the stream below it. Thus a certain portion of the water is led away from the boom, which has, therefore, less pressure to withstand. Fig. 268 represents such a channel,

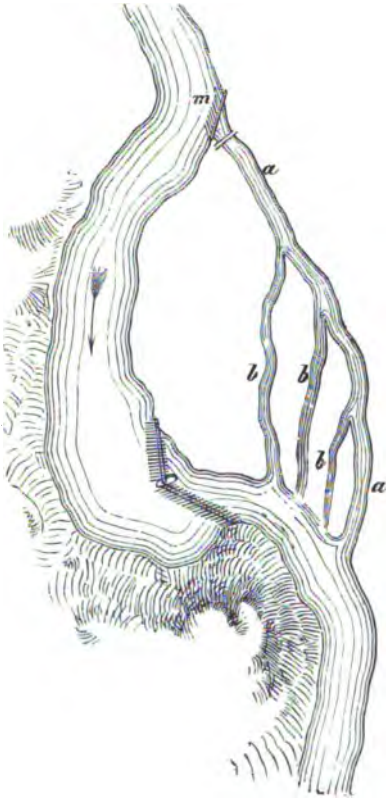

Fig. 268.—Side channel taking pressure off a boom.

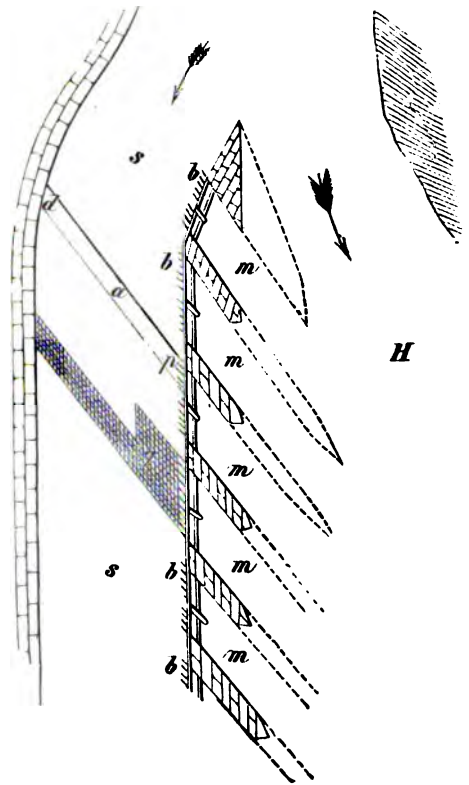

Fig. 269.—Floating-channel with sand-grating.

which is supplied at its outlet (*m*) with a lateral boom and sluice-gates and sub-divides below into several branches (*b b b*). If the terminal boom were also in a side-channel, which has besides the advantage of a weak current, its utility may be increased further by smaller channels taken from above the boom and returning into the other below it.

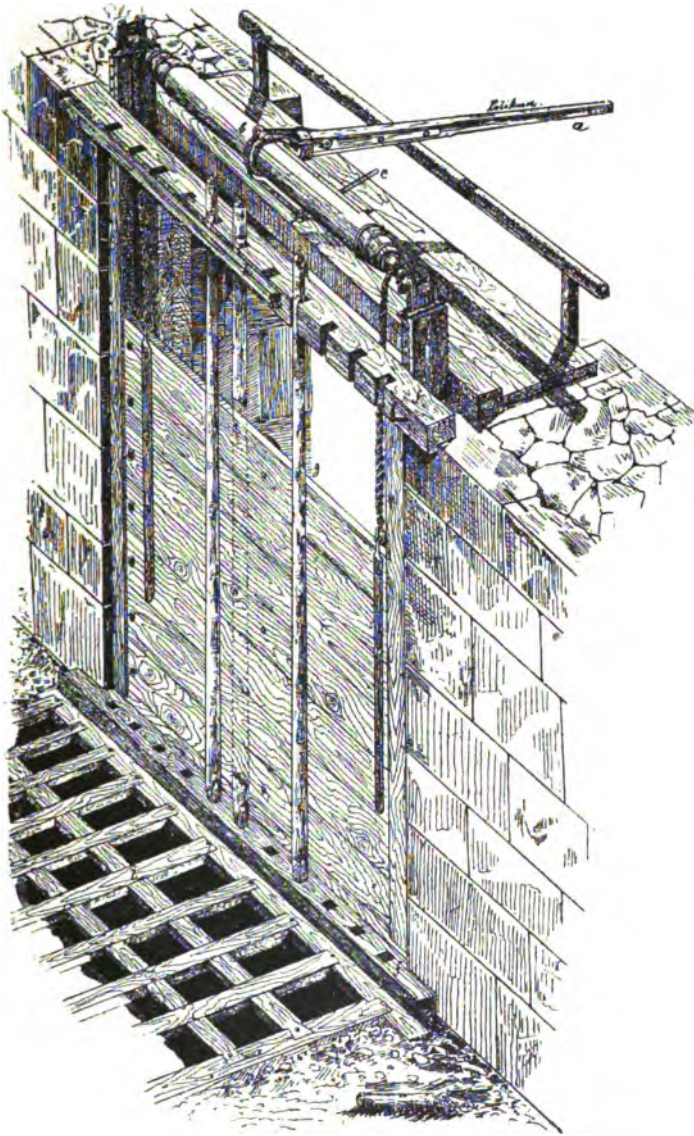

Fig. 270.—Sand-grating and sluice.*

* From "Atlas zum forstliche Transportwesen," Förster, Vienna, 1888.

Booms in streams that bring down boulders and gravel, besides the force of the current and of the floating wood, have to withstand the pressure of the sand and boulders. Wherever, therefore, the fall of the stream is considerable, it is sufficient usually to place the boom out of the main current by allowing surplus water to pass off by a side-channel; or, when the boom is in a side-channel, a deep and steeply inclined cut, termed a *sand-canal*, is made in the latter to carry the sand and boulders into the main stream. Fig. 269 shows the floating-channel (*s, s*), which bifurcates from the main stream, *H*; *m, m* form so many cuts between strong, solid masonry walls, which may be closed by lateral booms and sluice-gates; *a* is the sand-canal, which at *d* is only half a meter deeper than the rest of the floating channel, but deepens gradually towards *p*. The boulders which accumulate in *d, p* are passed through a temporary opening (*p*) and the corresponding sluice-gate in the lateral boom, and pass along *m* into the main stream *H*.

Simple sand-canals can be opened for the passage of silt, etc., only whilst floating is not in progress. In order to free a floating-channel from these accumulations during the floating, they may, as at *q*, Fig. 269, be covered with a wooden lattice-work (Fig. 270) constructed at the bottom of the floating-channel (*s*). Besides this method, double booms may be used, which are erected the one close behind the other, and the silt and boulders are admitted into the interval between them by opening the first boom and then passed through the second boom, so that always one of the booms is ready to stop the floating wood. In order also to expose the bed of the stream in front of a boom and then strand the timber, deep culverts with sluice-gates may be made and opened to pass the water under the boom.

(c) **Further Details regarding Booms.**—In the preceding paragraphs, a distinction has been made between **lateral** or **terminal booms**, but the latter may be of several kinds. Every boom, whatever its dimensions, which catches floating wood at a timber-depot is a **principal boom**. Owing to certain conditions of a locality and want of sufficient space, it is not always possible to supply every river timber-depot with a principal

boom ; or the risk cannot be incurred, in the case of numbers of saw-mills situated along a stream, of entrusting the supply of the thousands of logs they require for their annual work to one boom only, which is always liable to be broken. In such cases, **subsidiary booms** are used in order to ensure a supply of wood for all the saw-mills.

For this purpose narrow parts of the stream are selected, confined on either side by rocks, and there booms with moveable gratings are erected, from which the wood can be again despatched down-stream in small sweeps to the different saw-mills or timber depots.

Not unfrequently a stream is broken-up by booms at not very long intervals ; this is either for charcoal-burning, in order to land the wood required where permanent charcoal-kilns are maintained ; or each forest-owner or principal wood-merchant has his own boom, in order to collect his own wood and float it separately from that of other owners to the principal boom ; or the saw-mills situated along the stream have each its special boom, provided with passages to allow extraneous wood to pass through them.

Subsidiary booms are erected sometimes in strong streams below the principal boom, where, owing to occasional floods, there may be danger of the latter breaking. Whenever floating timber is rafted, or passed in lines of logs across a lake, most of the water-logged wood would enter the lake and sink to the bottom without possibility of recovery, were not a boom stationed at the point where the stream used for floating passes into the lake.

4. *Method employed in Floating Wood.*

(a) **Season for Floating.**—The more quickly a sweep of wood is floated and reaches its destination, the better is the business of floating conducted. For this purpose, a steady and ample supply of water is necessary. The melting of the mountain snow in spring brings most water into European streams, and spring is therefore the chief season in Europe for floating timber. At this season all the brooks and springs which flow into the floating-channel are swiftest and most

buoyant, owing to the coldness of the snow-water. Thus all reservoirs and tanks can be filled readily, and the largest possible volume of wood brought down in the shortest possible time.

The weaker the floating-channels, the greater care must be taken to utilise, for floating, the critical period in the spring, after the snow has disappeared. Although in mountainous districts, with heavy rainfall, the period of melting snow brings down sufficient water into the streams for floating purposes, floating is protracted frequently into the summer months, it then requires all the help of an artificial supply of water. In such cases, the forester will direct his attention to the summer rains for supplying his reservoirs. It is evident that the whole prosperity of the saw-mill industry depends on a choice of the right moment for floating the wood.

Floating on large streams permanently well supplied with water, and on smaller streams supplied from lakes and reservoirs, may continue throughout the year. In such cases it is preferable to float in the autumn, when floods are less to be feared than during the spring. [This is the case in India with rivers such as the Jumna, where the principal boom is always removed from May till November, when the river is swollen with snow-water and water from the summer monsoon.—Tr.] In high mountain-regions floods occur late in the spring and in the early part of summer, and it is therefore in several districts safer to choose midsummer (in the Italian Alps, late autumn) for floating, especially where protective works against floods are wanting.

Small reservoirs may be filled three or four times in a day, but large ones may require several days to fill.

(b) **Nature of the Wood to be Floated.**—Saw-mill butts and the better kinds of firewood (split billets, and large round pieces) are floated. [In India also railway-sleepers and other scantling.—Tr.] The butts are first barked and trimmed free from knots and stumps of branches, and frequently rounded at both ends to guard against splitting. Firewood and charcoal-wood is floated either in round butts (twice the length of the ordinary billets) which are sawn and split into billets after landing at the booms, or in split billets.

Whether it is preferable to float butts, or split billets, depends on circumstances; butts require a stronger current, though in a floating-channel they are less liable to breakage by boulders, etc., than billets, which require improved channels with a moderate current. It is evident that light coniferous butts are floated more easily than broadleaved ones; also, wherever carbonisation is effected with round pieces, as in the Alps, they must be floated in that form. Butts for saw-mills require stronger water than firewood, lengths of 3 to 4 meters (10 to 13 feet) being most suitable, although in Sweden, butts are floated up to a length of 7 meters (23 feet). It is often difficult to float heavy butts, especially of silver-fir, unless they have been previously dried.

The most important operation, before floating is undertaken, is that of drying the wood, for the amount of water-logged wood varies inversely with the comparative dryness of the wood when launched. Wood felled in the growing season dries more quickly than winter-felled wood, and is therefore more easily floated. It is indispensable to dry thoroughly the butts that are to be floated for long distances.

It is especially requisite, from a consideration for the quality of the wood, that butts felled and barked in the summer should be removed from the felling-areas immediately after felling, and deposited in airy depots, in order to become thoroughly dried. If, then, during winter wood is brought to the side of the floating-channel, not only does the drying process improve its quality, but also facilitate the operation of floating.

(c) **Conservancy of the Floating-channel.**—Before the wood is thrown into the floating-channel, the condition of the latter, and of the different works which have been constructed to improve it, should be known. For this purpose, an inspection should be made, preferably with the co-operation of riparian landowners, owners of saw-mills and other hydraulic works along the floating-channel; enquiry should then be made into all claims for compensation for damage done by the floating-gang, in order to prevent unfair excess in its amount, and, if necessary, these claims should be settled by arbitration or the law-courts. This inspection should, if

possible, take place in fine weather and when the water is clear, so that the bed of the stream may be seen.

As this inspection serves for settling excessive claims for compensation, it should be made as soon as possible after the previous year's floating is over; it is also useful to assist the forest-manager in deciding about the suitability or defects of any of the works along the water-channel. It is clear that repairs to these works cannot be postponed till shortly before the floating season; they must be done, together with any new indispensable works, when the water is low in summer or early in the autumn. The same proviso holds good for clearance of the floating-channel, which is required both in its lower course, where the current is sluggish, and also in its upper course, among rapids and boulders. Whenever it is necessary to expose any portion of the bed of the channel for this purpose, arrangements should be made to procure the necessary stoppage of all mills, etc., for the purpose. The days on which the stream is allowed to run dry are either fixed by law, or secured by compensation to the mill-owners; only owners of works established on the stream before it was used for floating are entitled to compensation.

(d) **Conduct of the Floating Operations.**—During winter and early spring the wood is brought to the side of the floating-channel, and placed on its banks in loose stacks. Should there be, as is frequently the case, a narrow valley just below the reservoir dam, so that the wood cannot be washed away laterally, it is frequently placed on the dry bed of the channel; then the pieces of wood should be scattered, so that when the dam is opened a jam may not arise.

If, then, all the wood from most of the felling-areas has been brought down, the efficiency of the floating-channel and its works has been ensured, and everything is ready at the timber-depots below for the reception of the wood, the first sweep of wood may be sent down at the right time. A careful choice of the latter is of great importance, and is a matter of days, even of hours. A commencement should be made always in the most remote and weakest of the subsidiary streams, so that the sweep of timber passing through it may come down as soon as possible into the main stream, where progress is

not so dependent on the period of the highest floods. Hence, a distinction may be made between **subsidiary sweeps** of timber and the **principal sweeps**.

Wherever the cost and difficulty of subsidiary sweeps is out of proportion to their utility, attempts should be made to substitute sledging for floating, as is being done already in the Alps. In other localities, as in the Palatinate, only subsidiary sweeps are attempted, the wood being floated right up to a railway.

Before the sluice-gates are opened, and floating the subsidiary sweeps is begun, the quantity of the wood to be launched should be proportioned to the quantity of water in the reservoir and the strength of the boom, otherwise there will be danger of the tail of the sweep being left stranded, or of the boom being broken, if a flood should occur. Due consideration having been given to these points, the sluice-gates are opened, and after the preliminary flooding, the strength of which depends on the amount of impediments there may be in the floating-channel, the floating-gang commence throwing the wood into the stream. As soon as most of the water has left the reservoir, the gang stop launching the wood, so that the residue of the water may have its effect on the tail of the sweep and carry it away. As soon as the reservoir is empty, the dam is closed again in order that a fresh supply of water may be collected.

In the case of floating-channels which cannot be flooded by a considerable body of water, but only by a moderate supply from fear of damage to their banks, it is the duty of the forest guard in charge of the reservoir to be careful not to supply more water at a time than is absolutely necessary. He will learn easily by experience for how many miles down the water from his reservoir can flood the floating-channel sufficiently, and how long the sluice-gates should be kept open to ensure a proper supply.

The wood now is carried down by the flood from the reservoir, and the best, smoothest, well-dried wood keeps at the head of the sweep, whilst inferior knotty wood and heavy butts gradually lag behind to form its tail. However well the floating-channel may be regulated, hindrances will arise whenever the wood

enters a difficult place and blocks the way for the rest of the sweep; it may thus block the channel and drive the flooding water over its banks, or in the most favourable case allow it to run away uselessly. In order to prevent such a mischance, the sweep is accompanied by some men of the floating-gang, and also men are placed beforehand at any places along the channel where a block is to be feared, so that with their hooked poles they may push off all pieces that are jammed. It is necessary for overseers to supervise these men, and hence, a fairly good pathway must be provided all along close to the side of the channel (*vide* p. 382).

Although in the case of floating split firewood billets in well-regulated channels the work may be very light and easy, it involves extremely hard labour and danger to life in the case of saw-mill butts coming down from high mountain-regions.

Wessely thus writes in his excellent work about the Austrian Alps:—"The mere releasing a jammed mass of logs is a formidable undertaking. In order to save labour, it must be set free from below; a single crossed log often detains the whole pile of timber; this is at once recognised by the woodman, who drags it out, but he has hardly done so before all the logs come crashing down on him and roll thundering down the flood. If he does not succeed by skill and good luck in jumping aside, it is all over with him. There is much *jodeling* over the break-up or a jam, but only too often does the mass of timber fall on the daring man who ventures upon it, and but rarely is he fished seriously injured from the flood by the help of a hooked pole. In gorges—and there are such 50 fathoms deep—a man is let down by a rope into the foaming torrent, and must actually stand on the heap of wood. If his comrades do not draw him back at the very moment when the logs are set in motion, he will be carried down hopelessly with them."

In the Bavarian gorges, as has been already stated, this dangerous work is assisted by means of galleries let into the rocks.

Once the wood has been carried down to the main floating channel, the sweep of logs now becomes the principal sweep and floats on to the boom. In the case of larger brooks and

ivers, the wood is left to itself, but if the water is shallow, assistance must still be afforded from reservoirs.

Usually the principal reservoirs of the subsidiary streams, if they help one another, and flow one after the other into the main stream, assist greatly in floating the principal sweep. Experience shows how long a flood from a reservoir takes to reach the main stream, and this period is chosen for the interval between the opening of the sluice-gates of neighbouring reservoirs. In long and weak floating-channels the reservoirs of the tributaries are not sufficient to maintain high water in the main stream, and in such cases reservoirs should be provided along the main channel. In floating a sweep great care must be taken that the reservoirs on the subsidiary and main channels work together well. As soon as the reservoirs of the tributaries are again full, more wood is launched and floated; this continues daily until all the wood has been launched and has gradually reached the booms, when it is either collected in tanks, or taken out of the water, according to the nature of the boom.

Whenever a floating-channel passes through a lake the wood must be stopped as it enters the lake and towed across it. Everywhere for this purpose light coniferous logs are used, which are bound together by iron rings, or withes; they thus form a long floating girdle which may be used to surround the wood in the lake and keep it together. With this object, the chain of logs is placed in an arc before the entrance to the lake, and as soon as it has enclosed as many logs as possible, its ends are joined. The raft thus formed is then borne to the other end of the lake, either by help of a favourable wind, by beasts or manual labour; the chain is then opened and the logs floated further down the stream.

Favourable weather is necessary for this crossing to be effected; storms not unfrequently break up these rafts and scatter the logs over the surface of the lake, so that great expense is incurred in collecting them. On the Pacific coast of North America, and also in Norway and Sweden, where it is quite usual to convey logs in those temporary rafts, screw steam-boats of light draught are attached to them, or they are dragged forwards by ropes attached to windlasses on boats

anchored in the lake. This practice is in vogue on the Tegern lake (Fig. 271). The wood floated down the river Weisach runs into the lake at *a*, is bound into temporary rafts and drawn by the anchored boat (*m*) to about the middle of the lake,

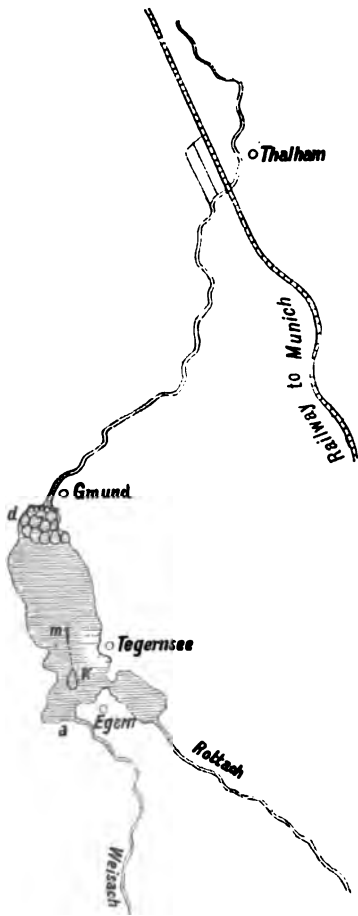

Fig. 271.—Floating wood across a lake.

whence the mountain-wind blows it to *d* at the other end of the lake. The rafts which are collected there are opened one by one, and the wood floated on the Mangfall river to the timber-depot at Thalham, where it reaches the railroad to Munich.

(e) **Completion of the floating.**—All the wood which has been launched by no means floats steadily down to the boom. Frequently, a considerable percentage of the launched pieces remains on rocks, shoals and other inequalities of the channel, sticks under its banks, or remains floating in the still water near the banks. All this wood should now be set free, drawn into the stream, or else placed so that it may be caught by the next flood from a reservoir, or natural flooding of the river, and carried down to the boom ;

this operation is termed **after-floating**. This work, which is often protracted well into the summer, is commenced usually from up-stream, but if after all the reservoirs are exhausted, or owing to unfavourable weather, the water in the channel is very low, only a portion of these stranded

logs can be floated before the succeeding year. In such a case it is better to begin from the lower end of the channel.

During the **after-floating**, but chiefly when a certain amount of progress has been made in floating off the tail of the sweeps, the sunken wood should be fished up, most of it being at the lower end of the channel.

The quantity of sunken wood depends on the amount of drying to which the wood has been subjected before being launched, the condition of the floating-channel, but above all, the nature of the banks, the fall and buoyancy of the water, the length of the channel, and the species, nature, and size of the floating pieces. Round pieces sink more readily than split pieces, and branches of spruce and silver-fir being much heavier than their stems yield a greater percentage of sunken wood.

The workmen use the hooked pole to spike the logs or billets and draw them to the bank. Fine weather is required for this work, and clear water, so that the bottom of the stream and all sunken wood may be seen. The wood is collected daily and piled in loose stacks on the bank of the stream, and when dry, it is either transported by land, or sold.

As soon as the annual floating is over and the sunken wood collected, a report is drawn up by the same commission which acted before the floating. In this report all legal damages are entered which neighbouring properties may have suffered from the floating operations, all legal compensation being paid. This opportunity also is taken to prepare a list of any damage which may have been done to the floating-channel or the works attached to it, so that they may be repaired in the ensuing summer.

SECTION II.—RAFTING.*

Rafting is distinguished from floating by the fact that the wood is no longer in single pieces, but is bound together into rafts. A quantity of wood firmly bound together is termed a **raft-section**, and a number of sections form a **raft**.

* Although rafting is done rarely by the forester, yet the rafts are made-up with withes and cross-pieces that he has to deliver. In certain districts, logs are measured only when they are bound into rafts, and frequently a floating channel is also a rafting-channel, and has to be prepared with that object in view. Forty per cent. of the 14,000 kilometers (8,750 miles) of German rivers are used for rafting.

1. *Rafting-channels.*

In order that rafting may be possible, generally it is necessary that the water in a stream should flow uniformly and gently, with only a slight fall. In well-regulated rafting-channels a smaller head of water is required than in mere floating-channels, but the depth must not be less than 2 or $2\frac{1}{2}$ feet. Although rafting may be done more favourably on the lower courses of streams and large placid rivers,* yet sometimes higher mountain-torrents are thus utilised. In such cases, however, where the channel is full of rocks and boulders and has a considerable fall, a larger head of water is required than for floating, for unless the rafts are carried over all obstacles in the water, they will be stranded and broken-up.

In the latter case, therefore, artificial supplies of water are requisite, and both reservoirs and weirs placed along the stream are employed to increase the head of water. The latter are either sunken weirs with a long wooden wall in the middle of which there is a passage which may be closed, or stone overflow - weirs. Reservoirs are not so valuable for rafting as for floating, as they do not concentrate the water in a certain part of the rafting-channel. On the other hand, this may be done effectively by placing weirs at short distances apart along the channel, when the water can accumulate between any two weirs to the height required by a raft.

Wherever the sections and rafts are made-up in powerful streams, a side-channel or basin is required wide enough for the logs to be turned and placed alongside one another. In smaller streams this is best secured by constructing weirs at places with shelving banks. In the upper portion of rafting-channels the rafts may be made-up in the bed of the stream at any suitable place with shallow water. It has been already remarked that tanks are used to supply water to rafting-channels; they are preferable to any other mode of strengthening the head of water, as they permit rafting to be carried-on without interruption.

* In 1883, a raft consisting of eleven sections, each containing 500 logs, and 800 ft. long, was towed 600 miles from St. John in New Brunswick to New York in ten days by two powerful steam-tugs.

The constant struggle in Germany to extend and improve commerce by reducing the cost of transport is now directed chiefly to the work of improving moderate-sized rivers by canalisation.* This cannot but have considerable influence on the rafting of timber and on the dimensions of the rafts and their mode of conveyance, etc., and arrangements should be made to allow sufficient way through bridges, locks and sluice-gates for the rafts. Accordingly, through the canalisation of the rivers Main, Neckar, Saale, etc., timber-rafting will be more and more extended to the lower courses of these rivers, if by forming suitable collecting-places out of the reach of floods and spacious tanks in which the rafts can be made-up and through which they can pass, the construction of large rafts is rendered possible. For if the rafting business is to be conducted on a large scale, spacious timber-tanks at central places to which rafts converge down the smaller streams are indispensable.

2. Rafts.

Raft-sections and rafts are made-up in various ways in different countries, the chief difference between them being due to differences in the kind of wood to be rafted. All wood-assortments may be rafted. At present, however, in Germany, Austria, Hungary, Russia, etc., only logs and sawn goods are rafted. Sawmill-butts are floated chiefly piece by piece, and even rafting firewood across lakes has been abandoned in

* [Inland navigation in France in 1900 :—

8,594 miles { 5,211 canalised rivers,
3,833 canals.

All but 475 miles of canals are in the hands of the State, and those are to be taken over. Traffic in 1895, 27,173,904 tons. Employment to 27,000 men and women, and 13,000 children.

| | | | | | |
|-----------------------|-----|-----|-----|-----|--------------|
| Building materials... | ... | ... | ... | ... | 32 per cent. |
| Coal and coke | ... | ... | ... | ... | 28 " |
| Agricultural produce | ... | ... | ... | ... | 13 " |
| Firewood | ... | ... | ... | ... | 7½ " |
| Iron and steel | ... | ... | ... | ... | 7½ " |
| Manures | ... | ... | ... | ... | 6 " |

In Britain many of the canals are in the possession of railway-companies, and their competition is discouraged, while railway-rates on timber are excessive. Time is not important in timber transport, and the timber is seasoning while it is in barges on canals. Free competition and extension of canals would benefit producers of timber greatly.—Tr.]

favour of the mode of floating with a chain of logs explained on p. 405. Wherever on large rivers the floating of firewood is not allowable, it is conveyed in barges,* or as ballast on timber-rafts. Logs are bound together by means either of withes or poles.

(a) Rafts of Logs.

i. Raft-sections made up with Withes.

A very convenient method of binding logs into sections is by means of withes. First the logs are stranded, being rolled along two pieces of wood gently inclined into the water, and arranged as in Fig. 272; the triangular holes are then cut in

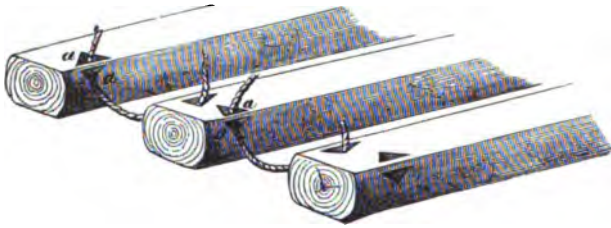

Fig. 272.—Fixing rafts with withes.

deeply with a special hatchet. The corresponding holes (*a a, a a*) are then completely bored, and the logs pushed back into the water and tied firmly in raft-sections by strong withes.

These withes are generally spruce branches, or dominated spruce or hazel saplings, which have grown for a long time under the shade of larger trees; they are first baked in ovens and then twisted, their thick ends being held by a special contrivance. The withes are from 1 to 6 centimeters ($\frac{1}{2}$ to 2 inches) thick, and their preparation for sale in many districts forms a special trade. On the Vistula, ropes made of lime-bast are used for tying the logs.

The number of logs which are bound-together into a raft-section depends on the breadth of the rafting-channel, and in

* Specially low, broad barges are built for the purpose on the Danube and other rivers. Those from Russia are 200 to 250 feet long.

certain cases on the width of the openings in the weirs. Usually the thicker ends of the logs are placed at one end of the section and their thinner ends at the other. In fastening the withes care must be taken to give the logs sufficient play so that at any rate each log may be able to move slightly in a vertical direction. This is absolutely necessary for watercourses with numerous little rapids and with inequalities in the bed of their channel, as each section is then better able to accommodate itself to the uneven surface.

On the channels with an even flow, and on the larger streams and rivers, the logs are fastened together as follows, with **rigid raft-sections**.

ii. *Raft-sections fastened with Poles.*

This second mode of making up raft-sections is shown in Fig. 273; it is much more common than the former method,



Fig. 273.—Rigid raft-section with pole.

and is in use on nearly all steadily flowing rivers, the Spree, Saale, Oder, Elbe, Main, Rhine, etc. The logs are landed and bored through at *a b* and *d c*, Fig. 274; they are then returned to the water and fastened to a pole (*m n*), as in Fig. 273. Generally beech poles are used, but also spruce and silver-fir poles. The poles being placed over the ends of the logs which are to be fastened and between the bore-holes in them, the thin end of a withe is passed through *a b* over the pole, and then into *c*. The thick end of the withe gets jammed in *a b*, and the thin end is fixed in *c d* by means of a wooden wedge. Instead of withes, the poles may

be fastened to each log by iron nails or clamps. In this method the raft-section is a rigid body, and no independent motion is allowed to the individual logs.

This mode of fastening has the great advantage, that the logs are much less injured by the bore-holes than by the larger holes made in the former case. In that case, the ends*

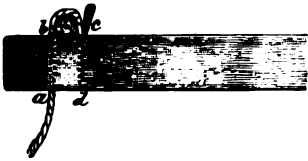

Fig. 274.—Method of fixing pole.

of the logs must be sawn off, whilst when the pole is used, the bore-hole can be plugged eventually with a piece of wood and the whole log become utilisable.

In powerful streams with numerous rapids, as in the river Isar, the poles or planks are sometimes let into the logs. The latter are grooved at their ends, so as to admit the plank, and then fastened to it as before. The raft-section thus fastened is more rigid and stronger than without the groove. In Moravia, only the

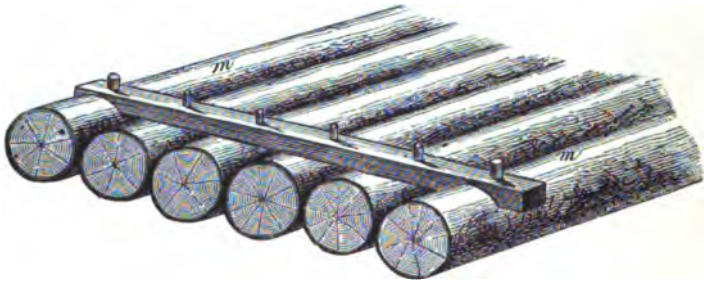

Fig 275.—Fixing a section by a plank.

outer logs are grooved, and trenails are used to fix the plank to the logs (Fig. 275).

The first condition for rafting is that the wood to be rafted is lighter than water, which is the case with all German woods except oak. Whilst, therefore, all other woods may be used alone to form a raft, oakwood must be mixed in rafts with other species which are light and will support it. For this

* These separate ends of floated logs are used in many places for paving stables.

purpose coniferous wood always is used, and is distributed among the oakwood in the raft-sections, so that they may be weighted as uniformly as possible.

Poles are used for fixing the sections, and are fastened to the logs with iron nails. In countries where the necessary coniferous wood is scarce, old wine-casks (on the river Moselle) are used to buoy up the rafts. It should also be noted that some oakwood will float well, and in that case rafts may be made-up entirely of light oakwood, as, for instance, well-seasoned Spessart oak.

(b) **Rafts of Sawn Timber.**—Of sawn timber, it is chiefly boards, planks and battens that are transported in rafts.

[In India, rafts are made-up of logs, railway-sleepers and other scantling, and bamboos.—Tr.] Boards are fastened together in various ways in different countries, one of the commonest methods being as follows:—

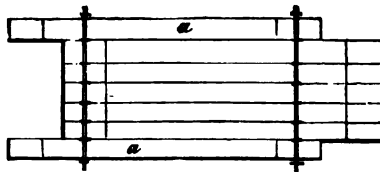

Fig. 276.—Plank raft-section.

Ten to fifteen boards are fastened together on a bank of the stream, and six or eight* such bundles of boards so placed that the two outer bundles (*a a*) project beyond the others (Fig. 276),

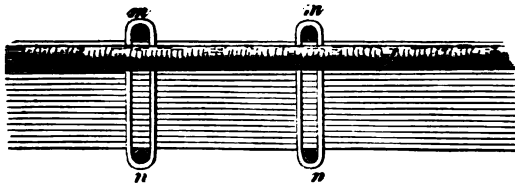

Fig. 277.—“Vertical” section of Fig. 276.

and besides, the lowest board of each bundle projects about 40 centimeters (15 inches) beyond the other boards. This is done, so that in making-up a raft out of the sections the latter may dovetail into one another. The six or eight bundles are now fastened together by means of two or more pairs of poles,

* These numbers are generally chosen, so that each raft-section may contain 100, 120, or 150 boards; 120 boards usually form a “standard.”

and one of each pair (*m m*) being placed above the bundles and one (*n n*) below, transversely to the raft-section, the withes are fastened round these poles, which thus enclose all the boards

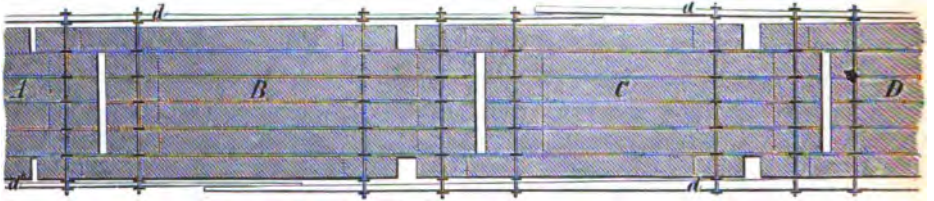

Fig. 278.—Union of sections to form a raft.

in the raft-section (Fig. 277). Such a section is quite rigid. The raft-sections fastened together on the land and slid into the water are then bound into rafts as shown in Fig. 278.

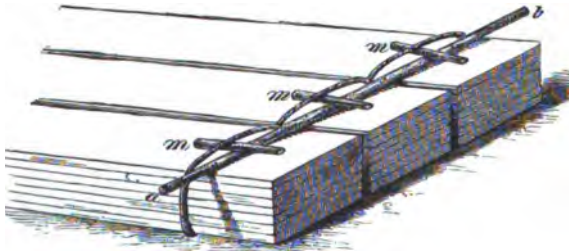

Fig. 279.—Method of fixing planks.

The sections *A*, *B*, *C*, and *D*, are not dovetailed together by their projecting borders, but long slender spruce poles (Figs. 277 and 278, *d d*) are fastened to their sides, passing from

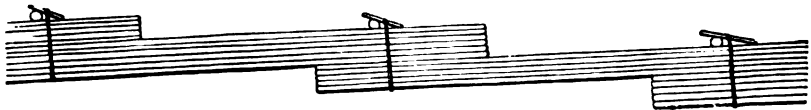

Fig. 280.—Plank raft.

section to section, and thus affording rigidity to the whole raft.

Another mode of binding rafts is shown in Fig. 279. The bundles of boards are tied with withes, but each withe passes

through that of the neighbouring bundles, so that the bundles are slightly bound together. The raft-section (Fig. 279) being thus made-up, a pole (*a b*) is fastened to it by the wedges (*m m m*). In the method of making-up rafts of boards, as shown in Fig. 280, the bundles of boards are fastened one below the other, poles being used for the purpose, as in Fig. 279. This method of rafting requires deeper water than the preceding ones.

(c) **Method of making-up Rafts.**—Several raft-sections are fastened together to make a raft. This is done either by attaching the ends of the sections together by withes, leaving them sufficient play—an important point in long rafts and in floating channels with sharp bends; or the sections are bound firmly together with withes, as is the practice on the river Kinzig, so as to make a rigid raft. The spruce poles, as shown in Fig. 277, are used also for fastening the sections together.

In binding the sections into rafts, the lightest ones are placed in front at the head of the raft, and the heavier ones behind in the tail. The more attention must be paid to this rule, the more rapid the stream of the rafting-channel, for the light sections float more freely than the heavy ones, and were the latter placed at the head of the raft, they would be pressed upon by the lighter ones, and the latter would even press the heavy ones down and mount on to them, rendering the management of the raft impossible.

It is a rule that each section should be formed of stems equally long and thick; if the sections are small, containing five to eight logs, the bases of the logs are all put together at one end of the section, and their tops at the other. Where the sections are larger, and the logs markedly uncylindrical, the butt-ends and tops of the logs are placed alternately side by side, in order to give the raft-section a uniform breadth throughout. Such raft-sections are united more easily in a raft.

3. *Dimensions of Rafts.*

A distinction is made between rafts only one section broad, the sections being placed one behind the other, and large rafts formed both in breadth and length of many sections. The

former class of rafts is in use in the upper and middle courses of rivers and brooks, whilst the latter is employed on broad, steadily flowing streams.

The former kind of rafts may, however, be very long, and often consist of from 40 to 70 sections hung one behind the other, containing altogether 300 to 500 logs and more. The large rafts, on the other hand, are often 50 meters (160 feet) broad and 200 to 250 meters (650 to 810 feet) long, and were formerly even larger.

4. Mode of Rafting.

A raft should be conducted so that it can be guided, its pace moderated, or it can be stopped at pleasure. On slowly

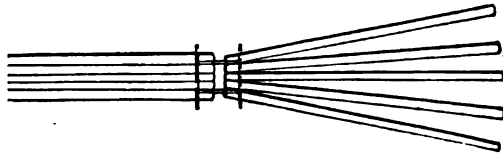

Fig. 281.—End section of raft.

flowing waters, ordinary spreads are used to guide the rafts. Where the current is rapid the rafts are made long so that they may travel slowly, and spreads are hung out behind the

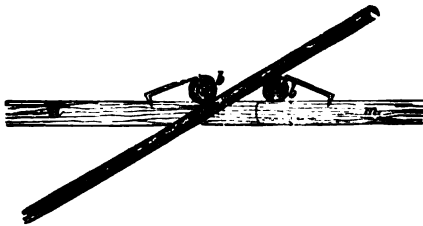

Fig. 282.—Brake for raft.

last section to drag along the bottom of the channel; the last section may also be opened out as in Fig. 281, or a kind of brake is used from the last section as shown in Fig. 282 in section and Fig. 283 in plan.

This brake consists of a stout beam (*a*) passing between two poles (*b*) fastened to the raft by clamps, or withes. The brake drags obliquely along the bottom of the channel, whilst it is firmly held above between the poles. In this way the pace of a raft may be regulated, and the raft directed through difficult passages and even stopped or stranded. Long heavy rafts on

fast streams with a steep fall have always several of these brakes on the last raft-section.

Rafting on shallow mountain streams demands the greatest attention and care, long experience of the rafting channel, and assiduous, trusty workmen. Men engaged in rafting require an amount of skill and daring which only experience from their youthful days can give. The workmen on the Wolf and Kinzig rivers and their tributaries, in the Black Forest, are veritable masters in the art of rafting; it is now proposed to follow a raft down one of these rivers.

The logs are floated down to a boom and sorted along the river-bank; then they are fastened together in its bed into raft-sections and rafts. The rafting-channel here is only 3 to 4 meters (10 to 13 feet) broad, with a rocky bed strewn with boulders and a fall of $\frac{1}{7}$ to $\frac{1}{2}$ (sometimes even $\frac{1}{8}$); in the worst places it is improved somewhat by simple weirs, and at the time the wood is floated has a depth of only 15 centimeters (6 inches).

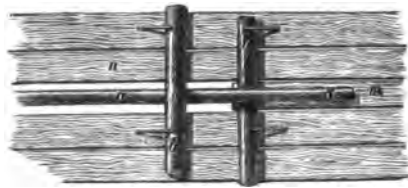

Fig. 283.—Plan of brake.

At longer or shorter intervals there are weirs in its upper course, and sluice-gates where its higher tributaries join it.

The raft, consisting of forty to fifty sections, is made ready, and attached by ropes to the shore. The front section consists of only four small logs, which run together like a wedge in front and terminate in a short piece of planking. The second, third, and succeeding sections increase gradually in width up to a middle width of 4 to 5 meters (13 to 16 feet); this is attained also by all the remaining sections of the raft, except the last, on which are the brakes, and which is as broad only as the water in the stream. The sections are fastened so that all the small ends of the logs are in front, which gives them a fan-shaped appearance as represented in Fig. 284. Owing to this form, the raft may be actually broader than the stream and the passages through the weirs provided that the latter are not narrower than *a b*, as the

wings (*a c* and *b d*) of the sections then fold back over the rest of the section, recovering their former position as they emerge from the passage. It is evident therefore that rafts for floating on mountain-streams must be throughout quite loosely jointed. Suppose now, the long raft, which is lying in the nearly dry bed of the stream and overlaps it here and there on both sides, is to be floated: a few days beforehand all the sluice-gates of tributary streams must be closed, as well as the sluice-gates on the weirs down-stream, so that as much water as possible may be available in the upper course of the rafting-channel. Men are posted out on the hills along the stream to receive notices from those in charge of the raft and pass them

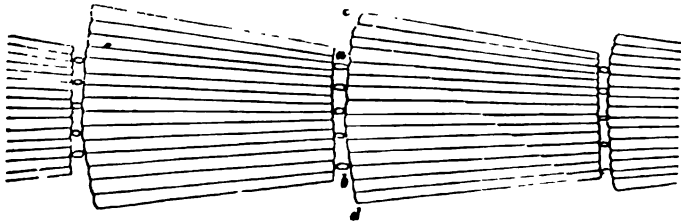

Fig. 284.—Flexible raft.

on (in Galicia, telephones, of a total length of 50 kilometers in one instance, are used for this purpose).

While the raft remains fastened firmly by ropes to the banks of the stream, the filled reservoirs and weirs up-stream are opened, and the foaming flood rushes over and past the raft. This flood must be allowed half-an-hour's start; for the raft, once released, descends the stream quicker than the torrent, and should the latter be caught up, the raft would run into the dry bed of the channel, and its end-sections overshoot its front-sections, forming a chaotic heap of logs. As soon as a sufficient start has been given to the flooded water, the ropes are loosened, and most of the men mount the five or six front-sections to direct the raft. All the other sections, except the end ones, are left to themselves, and, as the middle sections are often broader than the bed of the stream, the butt-ends of their wings dash along the banks. Men are placed also on the four to six last sections to manage the brakes. The brakes

are used now at short intervals to slacken speed at narrow places and dangerous corners, and the men must know exactly when the front of the raft will reach a dangerous place so that they may apply the brakes in time. When the brakes are applied, the whole raft creaks and shakes through all its members, and the last sections spring up and down according to the inequalities in the bed of the stream. The men with the brakes have hard work to do, for when the brake is withdrawn by removing the withes which bind it to the raft, it has to be replaced in time for the next dangerous passage. Meanwhile the raft floats so rapidly down-stream that a man running full speed along the bank can hardly keep up with it.

The first flooding of the stream may take the raft down from five to ten miles; then the water runs dry, and the raft lies on the bed of the stream until sufficient water is collected for a second flooding, when the work recommences. Once the raft has reached the broad and deep water below there is no more difficulty about conducting it to the junction with a large river.

Only spreads are used in guiding rafts on large rivers. On the Rhine different kinds of spreads are used, either spruce boards or long logs cut into shape of a board at one end. The larger kinds of spreads are so heavy that they are moved by a number of men, who push them with their shoulders and take several strides in turning them. The men need not leave their places to move the smaller spreads. The rafts are pulled ashore by means of anchors fixed to the shore, and attached by ropes to the raft.

On the larger German rivers, both logs and sawn timber are rafted, and the rafts are further laden with firewood, oak planks and scantlings, laths, staves, vine-props, poles and many other wares, termed *raft-ballast* (*Oblast*).

[On the Brahmaputra and Ganges rivers, heavy logs of sal (*Shorea robusta*) and other wood, which will not float in water, are attached by ropes to long poles fastened across large buoyant boats; they are thus floated down-stream.—Tr.]

CHAPTER V.

COMPARISON BETWEEN DIFFERENT MODES OF
TRANSPORT.

THE various modes of transport described above must differ considerably in value in different cases. For many forests no choice is possible; the local conditions absolutely decide the mode of transport. In the case of other forests, especially in moderately elevated or high mountainous regions, several methods may be followed, and the question is, which of them is preferable? Some of the chief points determining the choice of any particular mode of transport for a forest are as follows:—

1. *Conditions of Locality.*

The configuration of the ground on which a forest is situated, the local climate, the density of population, the habits of the people and the method of agriculture followed, all influence the mode of wood-transport. In flat or hilly districts, with mild winters, dense population and plenty of strong beasts of draught, it is evident that throughout the year there will be less difficulty in transporting wood in carts or on forest-tramways, than in mountainous districts; this is specially the case with steep slopes, where road-making is difficult on account of the destructive action of water, the number of beasts of draught is limited, and snow falls heavily every winter. Under the latter conditions, **sledging**, or a partial use of **slides and chutes**, is to be recommended. For descending very steep slopes **wire-tramways** are best and deserve more consideration than has been given to them hitherto.

Floating and rafting can be followed only where water-courses are available. As regards **floating**, mountain districts are more suitable than hills and plains, where the presence of evenly-flowing streams renders **rafting** a suitable method; **rafting** is also permissible and actually practised along some of the weaker mountain-streams.

Although much thought has been expended on the advisability of abandoning chutes in mountainous countries, for they need constant repair and are known to be prejudicial to forests, as yet they cannot be dispensed with in high mountain districts. At the same time, they may be replaced gradually by **sledge-roads** and improved **floating-channels**. **Log-slides** along made roadways, however, will prove always a useful method in mountainous districts. In the Alps and other neighbouring countries **floating** has been always a prevalent mode of transport, and will remain so for many districts. Floating is followed much less in the plains and hills of North Germany, and even then chiefly for firewood, whilst **rafting** is pursued extensively on large rivers and canals. It is much easier to lay-out and use **forest-roads** and **tramways** in the plains than among mountains, but recent experience in the Vosges and elsewhere shows that the fact of a district being mountainous need not exclude these modes of transport.

2. *Wood-assortments.*

Although every felling-area yields a number of different wood-assortments, yet only a few form the great majority of its produce: frequently one single assortment determines the revenue of a forest, and therefore may have a decisive influence on the choice of the mode of transport. Butts and firewood may be transported in various ways, but logs, poles and coppice-wood cannot be **float**ed, though suitable for all kinds of **land-transport**, whilst logs form the chief object of **rafting**.

In mountainous districts there are many forests that produce splendid long pieces of timber, but at present yield sawmill butts only, the stems being cut into lengths of 3 to 4 metres (10 to 13 feet) for floating, because, rightly or wrongly, the forest-owners consider this mode of transport alone justifiable. [In the Jura long logs are transported on splendid cart-roads, while in the Vosges sawmill butts are the chief produce and are brought down on sledges.—Tr.]

3. *Cost of Transport.*

The cheapest is also the best transport, if it is sufficiently expeditious and prejudices neither the forest, nor the wood

it produces, in quantity or quality. The cost of transport is affected greatly by the cost of construction of the necessary works, their effectiveness and durability, and the cost of their maintenance. It should be noted that the crucial point lies rather with the actual current charges for transport and maintenance of the works, than with the original capital expenditure on construction. From these considerations, however, it cannot be laid down as a general rule, which method will be cheaper, or which dearer.

If only the cost of construction when compared with current charges were to decide the question in mountain-districts, a well-designed network of cart-roads and slides must be abandoned for ever, for such works, especially among high mountains, require a very large capital expenditure; also then all ideas of constructing forest-tramways would be illusory. Whilst, however, the original cost of other works, such as wooden slides or wooden works on a floating-channel, is comparatively low, the cost of maintenance in their case is very high. This is also the case as regards the cost of using wood instead of stone in works on roads or floating-channels. In most cases an estimate of the cost of the works will show, that unless the price of wood is very low, the greatest attention must be paid to solid construction and durable material. Even where the prices of wood in the forest are locally and temporarily depreciated, there can be no reason for neglecting modern and rational modes of transport, improvement in transport being followed always by higher prices.

How illogical it is that a forest-owner should be frightened by the prospect of large initial expenditure on durable means of transport, is borne out by actual experience in the case of forest-tramways. Independently of the great advantages they ensure for expediting the transport of forest produce to the centres of the timber-trade, for facilitating the sale of inferior assortments, for a rapid clearance of the felling-areas, preventing a loss of wood, etc., the transport charges are actually much lessened when compared with ordinary cart-traffic, so that good interest is obtained for the capital which has been invested. In the Grimmig forest range near Potsdam, the cost of transporting a cubic meter (35·8 cubic feet) of common

pine timber on the $2\frac{1}{2}$ kilometers ($12\frac{1}{2}$ furlongs) of forest tramway is 0·62 mark ($7\frac{1}{2}d.$), whilst its cost by cartage is 1·50 to 2 marks (1s. 6d. to 2s.). On the tramway in the forest range of Barr in the Vosges mountains, the cost of transport for a cubic meter of timber or firewood in the year 1889 was 75 pfennigs ($9d.$), whilst cartage for the same distance cost 1·84 marks (1s. 10d.). The forest tramway at Rothau in the Vosges may be confidently expected to yield 6 per cent. on its initial cost, for the cost of transport per cubic meter is now 1·60 marks (1s. 7d.) compared with 4·50 to 5 marks (4s. 6d. to 5s.) by cartage. The cost of construction of the tramway in Ebersberg forest was very high, in round figures, 20,000 marks per kilometer (£1,600 a mile) for the main line, and 4,000 marks per kilometer (£320 a mile) for the branches (including lading apparatus, rolling-stock, etc.). It has, nevertheless, been possible to deliver a cubic meter of wood for 31 pfennigs ($3\frac{1}{2}d.$) at the nearest railway-station, for which the cost of cartage would be about 10d. The cost of constructing 105 kilometers of forest-tramways in certain Prussian provinces averaged 4·32 marks per running meter (4s. a yard). The tramways in the Saxon forest-ranges of Rossau, however, cost 8·95 marks per meter (8s. 3d. a yard).

Water-transport by **rafting and in barges on streams and canals** has been always one of the cheapest modes of transport, and so, in many cases, has **floating**. As regards floating, however, the crucial points are: not too much cost in maintenance of works and conducting the business, and especially a considerable length of floating-channel. A regulated floating-channel always involves expensive construction for reservoirs, dams, booms, maintenance of the banks of the stream, etc., and these consequently increase the cost of floating, the more, the shorter is the floating-channel. For the annual conveyance to a distance of large volumes of butts and firewood, floating has been always one of the cheapest of methods practised; it often repays the cost of constructing works in solid masonry.

4. *Loss of Volume.*

The quantity of material loss of wood during transport depends on the configuration of the ground, the mode of

transport it necessitates, and also on the distance over which it has to be transported. In plains and low mountain-ranges there can be no question of any loss of wood during cartage or sledging on good roads, or in transport on tramways; this is also generally true for log-sliding. There are also well-regulated floating-channels on which scarcely any loss of wood is experienced. In the higher mountain-ranges, however, where usually several modes of transport are combined, where there is an insufficiency of good roads, where the floating-channels are impeded by rocks and boulders, and where wood must pass over long slides or be thrown down chutes, it is evident that loss of volume is unavoidable, in spite of every precaution. By the loss of bark (which for timber forms 10 to 15 per cent. of the whole volume) chiefly by friction during the process of landing, or of wood sticking on rocks, etc., or sinking in the stream—in such cases and where a long distance is floated over—the loss of volume may be considerable and reach 10 to 20 per cent., or more.

[In India, a good deal of floating timber is stolen: between 1884 and 1886, 3,200 railway-sleepers were stolen from the Tons river, one side of which is not in British territory, out of 100,000 sleepers floated. There is also much scourage, owing to the rocky nature of river-beds, and railway-sleepers intended to measure 6 feet by 8 inches by 4½ inches are cut 6½ feet by 8½ inches by 4¾ inches to allow for this.—Tr.]

In order to give an idea of the loss of volume in high mountain-districts, the results recorded for the Ramsau forest range, near Berchtesgaden, will be given. Here, as in most mountain forest ranges, all modes of transport are used, and late in the spring the wood is thrown down chutes (p. 278); the consequent loss of volume, varying with the length of the fall and the nature of the ground, is not less than 2 per cent., but not more than 12 to 15 per cent., for were it greater than the last figure, the utilisation of this unfavourably situated forest must be abandoned. Once the wood has thus gone a certain distance it is conveyed further by means of slides, roads, or floating-channels. In sliding, if the slides are not interrupted by chutes, there is little loss, scarcely more than 1 per cent. on fairly good slides, but if the slides are very

steep and combined with chutes, the loss may attain 15 to 20 per cent. and more. In transport on sledges and carts there is loss only when part of the wood is dragged behind the sledge as a brake, and even then the loss seldom exceeds $\frac{1}{2}$ per cent. Where sawmill butts are slid on the ground, or thrown down-hill, as is sometimes unavoidable, greater friction and loss ensues, which is at least 10 per cent. The loss in floating varies between 2 and 15 per cent. of the volume launched. Since frequently very different modes of transport are combined, as in the Ramsau forest-range, it is difficult to assign the amount of loss to any one of them in particular, but on the whole it may be admitted fairly that in land and water transport there is 6 per cent. of loss, of which 4 per cent. is in land-transport, and 2 per cent. by water. According to old observations made at the salt springs of Berchtesgaden, the loss in land-transport and floating to the timber-depot there was 5 per cent. from the Bischofswies, 8 per cent. from the Hintersee, Ramsau and Schwappach, 20 per cent. from the Königsee, and 30 per cent. from the Röth, a fall over a steep incline 600 meters (1,950 feet) high. At present, in all these districts, great improvement has been effected by constructing good sledge-roads in all directions.

5. Deterioration in Quality of the Wood.

The deterioration in the quality of wood during transport consists in **external and internal damage.**

The former kind of damage may be recognised as soon as the wood has reached its destination by a brush-like loosening of its fibres at either end, in the case of both butts and fire-wood billets. To this may be often added a certain number of radial cracks.

The internal damage is of much greater importance, affecting as it does the soundness of the wood; land-transport cannot have any influence in this respect, but floating is held to be a cause of decay, which in the case of sawmill butts is often considerable. Provided the floating is effected properly, it could not be solely responsible for this, supposing that it were always possible to take the necessary precautions. But frequently this cannot be ensured, and

consequently in the outturn of the sawmills there must be a certain proportion of unsound boards and scantling. In so far, therefore, as floating actually increases the difficulties and practical impediments in the way of a rational treatment of wood, it is advisable, wherever it is not susceptible of improvement, to limit its use, at least as regards valuable timber.

6. *Influence of Railways on the Timber-trade.*

It is easy, from observation of the freight of goods-trains which pass through forests, to form an idea of the share that the ordinary railroads of a country take in the transport of wood. By the co-operation of branch-lines and road-railways the meshes of the railway-net are constantly narrowing and a great and important future is being prepared for facilitating the transport of wood by the use of railways, and by uniting them with main forest-railways and portable tramways. Plains and hilly districts alone can profit fully by these benefits; and although mountain forests, as we have seen, may participate also to some extent, it is chiefly long, gently inclined valleys, penetrating the interior of mountain-districts, where projects for the construction of forest-railways can be entertained at present. In general, however, the decisive arguments for and against the adoption of a forest-railway are:—whether large quantities of wood are available for trade along a given line of export, or the produce of a forest has to be distributed in detail to satisfy merely local demands; the total amount of the produce in question, which may be augmented temporarily owing to damage by storms, insects, or other causes of injury; and sometimes the probable duration of the demand for the produce. This last motive may also involve serious danger to the forest, in case the existence of a forest-railway should lead the manager, by over-felling, to pass beyond the limits of true forest conservancy.

It is in the interests of silviculture, especially for the reproduction of the standing-crop, to extend portable tramways as much as possible, in order to remove the produce of secondary fellings and standards in full-sized logs without injury to the young crop, and thus supply a quick and cheap transport of wood from the constantly shifting felling-areas to the nearest

timber-depot, or to a junction with an ordinary railway-line. It is, however, evident that for such a purpose only plateaux and plains can be utilised. The introduction of portable tramways into the forest-range of Einsiedel-Bebenhausen is well worthy of imitation, for there also a considerable saving of expense as compared with cart-traffic has resulted.

[British railway-companies are often the owners of steamers and of quays at seaports, and therefore in order to attract custom favour the transport of foreign timber, by charging lower freights than for home produce* from intermediate stations. The rates for transport for home-timber are also much higher than on Continental railways, as the following table shows :—

| | Per ton per mile, in pence. |
|-------------------|--------------------------------|
| England | 2·5 |
| Belgium | ·6 |
| France | ·7 |
| Germany | ·57—Tr.] |

7. Canals.

In lowlands, canals are even more useful than railways, owing to the reduced cost of transport which they involve. The network of canals in Prussia is now being rapidly extended, and enormous quantities of indigenous and foreign timber are carried by the various canals. Canals are now being constructed to unite the Rhine with the Weser, and also with the Danube and Main (*cf.* p. 409).

8. Conclusion.

Facilitating wood-transport by increasing and improving the means of communication within and outside the forest has become a question of the first importance. Forestry has in many places lagged behind almost every other industry in this respect. Owing to the situation of forests, transport

* In the United States of America, owing to cheap acquisition of land for railways and rough construction, the capital expenditure is much less than in the United Kingdom. Consequently freights for timber are much lower; and owing to the plan of charging by complete car-loads, instead of merely by weight as here, a car-load is hauled for 1,000 miles for 12s. or 13s. per ton, costing more here for 100 miles.

from them is most difficult, but this does not relieve foresters from the duty of making every endeavour to utilise all present engineering resources, so as to reduce, as far as possible, the present high rates of timber-transport. Apparently the present tendency is to curtail floating in favour of land-transport, either by cart-roads or tramways.

Success in carrying out this programme will be justified at any rate by the consequent improvement in the quality of timber; its adoption is further enforced owing to the constantly increasing utilisation of water-power by other industries, in most cases incompatible with the use of the same streams for floating. Changes in the mode of transport are occurring constantly, as sawmills are established more and more in the interior of forests. Nevertheless the time is far distant when floating and rafting will disappear completely from the list of means of forest-transport, and in many districts they can never be dispensed with.

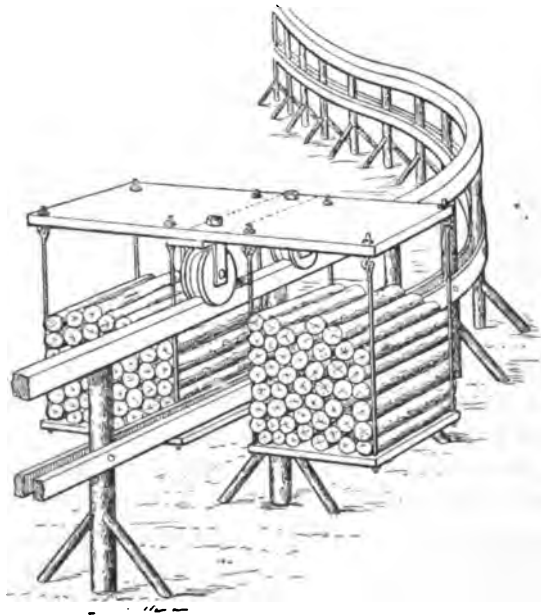

Fig. 284A.—De Coulon's monorail at Neufchateau.
After Mathey. (*Cf.* p. 334.)

CHAPTER VI.

WOOD-DEPOTS.

In order to collect transported wood in an orderly way, and store it for a longer or shorter period, a site must be selected for a permanent wood-depot, from which it may pass into the hands of the wood-merchant or consumer. Cases occur not unfrequently when it is necessary to keep the transported wood, especially logs and sawmill butts, in water until it is used, but usually wood is stored on land and kept dry.

The arrangement of a wood-depot differs according as the wood has been transported by land or water.

1. *Land-depots.*

Any well-drained area, sufficiently extensive and accessible to cart-traffic, will serve as a depot for wood transported on carts, tramcars or sledges. In collecting and storing logs,



Fig. 285.—Arrangement of logs in depot.

which are to be transported further by the purchaser, all that is required is to arrange them in an orderly manner after duly considering the available space. If there is plenty of room and the logs are to be numbered, measured and registered at the depot, they may be arranged as shown in Fig. 285, or the logs and butts may be placed in three or four layers, crosswise, one above the other. If there is not much room, and no necessity for estimating the volume of the wood, the logs and butts may be rolled into heaps, as in Fig. 286. In

any case, precautions must be taken to keep the logs raised above the ground, and to secure for them free admission of the air.

If the wood is to be sold in lots at the depot, it should be arranged in suitable lots, according to trade custom.

Wherever logs are to be stored for a number of years, it is best to keep them under water, provided they are immersed completely, and there is a moderate inlet and outlet of the water to prevent its becoming stagnant. Logs are then preserved most securely for several years from decay and cracking, and can be converted readily into planks, scantling, etc. If it is not possible to submerge the wood,

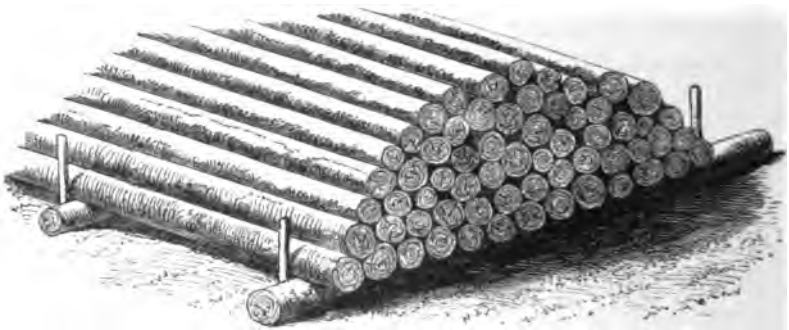

Fig. 286.—Stacking logs in a depot.

and large quantities of wood must be stored dry for several years (as after insect-attacks, storms, etc.), the greatest care must be taken to isolate them from ground-moisture. Logs, therefore, are barked thoroughly and rolled into parallel rows one above the other, in shady places, which are not exposed to dry winds; also the stacks of logs are covered lightly with sods, to protect the logs from cracking in dry weather. The wood suffers least of all on northern aspects. Under similar circumstances, spruce logs keep better than silver-fir or common pine, and logs better than butts.

In depots used for firewood brought by land, only the best class of firewood will repay further land-transport. Firewood requires the same precautions as timber, and generally firewood depots also should be fenced and furnished with a gate,

which can be locked. The arrangement of the wood is done in a way similar to that in river-depots, which will be now described.

2. River-depots.

A large number of depots are used for storing wood after transport by water, and then arrangements are required differing from those described under "Land-transport," especially after the wood has been floated.

The necessary characteristics of a good river-depot are:— immediate proximity to the floating-channel; a site thoroughly exposed to air and wind; the soil formed of sand, gravel or boulders to a depth of at least half a meter ($1\frac{1}{2}$ feet)—otherwise it should be paved with large stones; elevation of a few yards above the highest flood-level of the stream, or in case the depot is so arranged that the wood lands itself, a sufficient fall in the different basins of the depot, that are separated by sluice-gates. In many cases it is also necessary to include protective works against floods, which will be described further on.

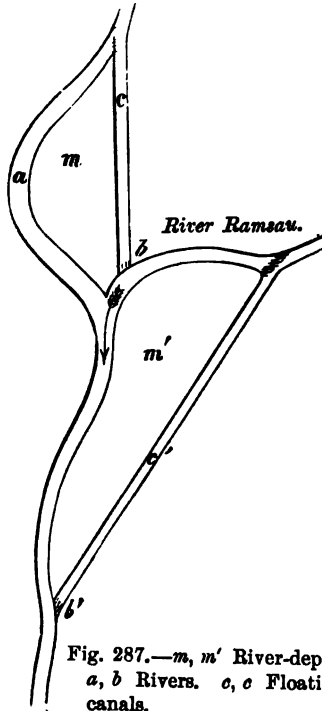

Fig. 287.—*m, m'* River-depot.
a, b Rivers. *c, c'* Floating
canals.

Wherever only a little wood is floated and labour is plentiful, generally a sloping bank of the stream above the boom, if otherwise suitable, is selected, on which the wood is landed. As then all the wood must be dragged from the stream, and many men employed simultaneously, the depot should extend for some distance along the river-bank and its breadth be reduced to a minimum, allowing sufficient room for storing and removing the timber.

It is a good plan to dig a canal from the floating-channel, which reunites with it lower down the stream. The land between the two watercourses will form a good depot. At the point where the canal leaves the floating-channel, the latter is barred by a lateral boom, the terminal boom being placed at the point where the canal reunites with the main stream. If the terminal boom is on a small weir, and sluice-gates are

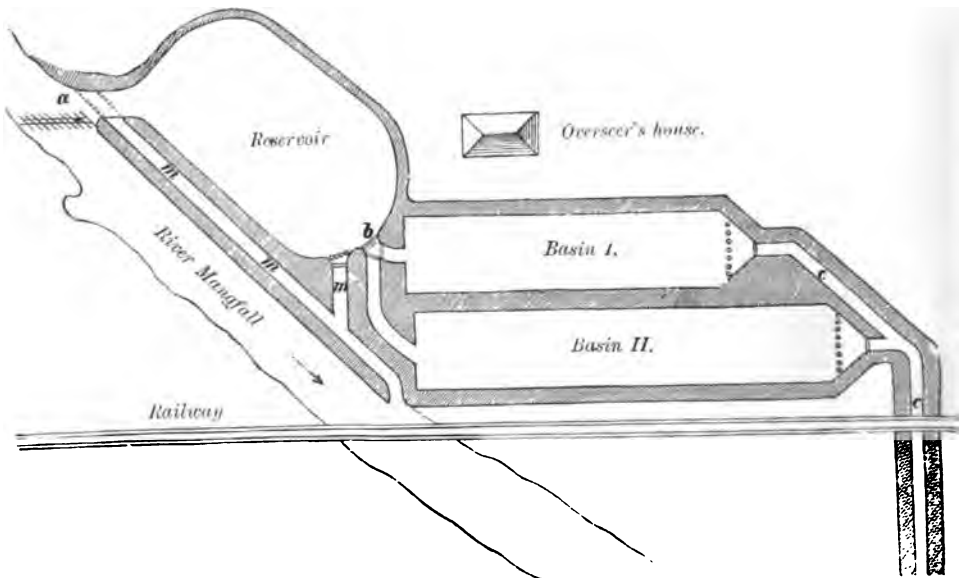

Fig. 288.—River-depot at Thalham.

supplied to the lateral boom, the wood can be stranded almost dry in the bed of the canal. Fig. 281 affords an example of this system in the river-depot at Berchtesgaden. The floating-channel (*a*) from the Königsee here joins the river Ramsau (*b*); canals and depots are provided for the wood from the Königsee at *c* and *m*, and at *c'* and *m'* for the wood from the Ramsau, whilst the terminal booms are at *b* and *b'*. The canals are paved with stone, and the wood is stranded almost dry.

Side-canals often bifurcate from floating-channels and lead to all parts of the depot, they again unite into main canals,

and these rejoin the main floating-channel. In such cases, the floating wood and the water are distributed, and the pressure on the sluice-gates and gratings, with which each side-canal is provided at its inlet and outlet, is as slight as may be. In order to attain what is desirable in this respect and avoid fracture of the booms and other calamities from floods, the main canals and sometimes the floating stream itself are provided with outlets. The best and largest river-depots such as those supplying wood for salt-mines in the Alps are constituted on the principle of leading the floating wood out of the main stream, and distributing it as much as possible in the different basins of the depot, so as to reduce pressure on the booms and save manual labour in landing the wood. As an example, the newly-constructed river-depot at Thalham, near Munich, may be cited (Fig. 280). Firewood is floated down the river Mangfall to the boom (*a*), and hence by a side-cut into the reservoir, where the wood is collected in a preliminary manner. The reservoir has two outlets (*m, m*) as a protection against floods; at *b* are two canals, each provided with booms and sluice-gates, leading to the basins (*I* and *II*) where the wood is received. The basins are surrounded by solid earth-dams faced with masonry, paved with stones, and provided at their entrances and outlets with sluice-gates. At the end of the basins are gratings, through which, after opening the sluice-gates, the superfluous water can pass through the outlets (*c, c*) back into the river Mangfall, leaving the wood behind the grating. By this arrangement the current and the floating wood can be conducted into either basin until it is full of wood. In a few hours, owing to the sloping nature of the bottom of the basins, all the water can be withdrawn through *c*, and the wood left stranded. Then it can be split on the spot and removed in a perfectly dry state. The firewood thus stored in either basin can be conveyed to Munich, as required, by the adjoining railway. Unfortunately this depot was injured seriously by a flood, a few years ago.

The extensive river-depots at Traunstein and other places serving for timber for saline works are now mostly abandoned, but there are still large depots in the Alps constructed on lines similar to those of the Thalham depot. As an example, the

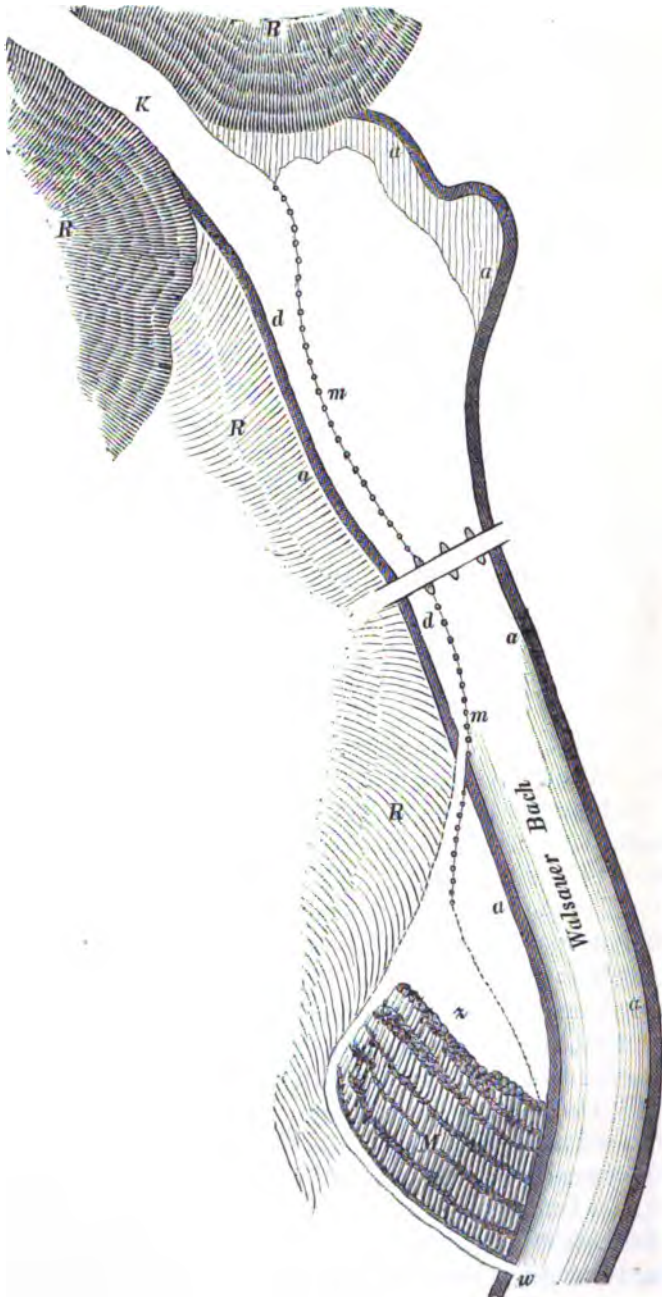

Fig. 289.—River-depot at Lana, near Meran.

depot at Lana, near Meran is given (Fig. 288). The stream *K* coming out of a rocky valley *R R* brings the wood between the strong river-walls *a, a* and the long boom *m, m* by the floating-channel *d, d* into the depot *z*, where the wood is stacked at *M*. The waste-water flows back into the river.

In all mountain-streams where floods occur, sawmills, as well as wood-depots, are placed in side-channels. This is essential, so that each mill may obtain its water-power separately and leave the main stream free for other mills and for floating purposes. In Fig. 290, the stream *A* is closed by a long lateral boom (*m*) at the outlet of the mill-stream *B*. *A*

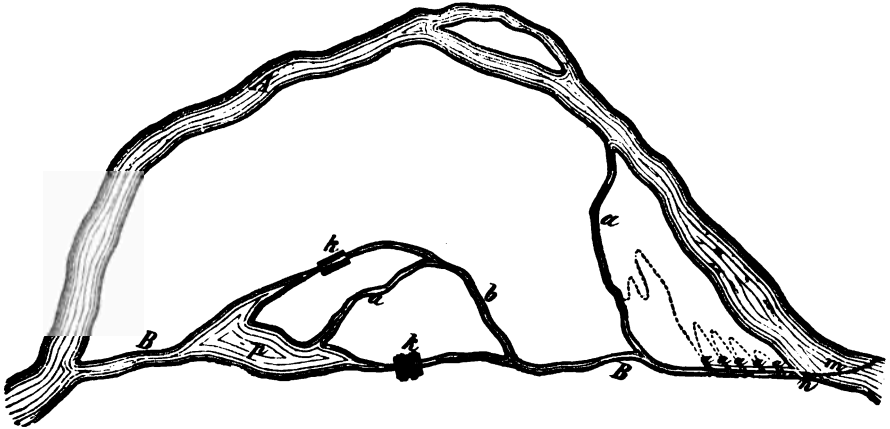

Fig. 290.—Sawmills, *k, k*, on a stream.

(*n*) is a second boom with a removable grating, behind which are sluice-gates, so that both the water and the floating wood may be under control; (*a, a, a . . .*) are outlets. The sawmills (*k, k*) receive the butts directly by water; the sawn boards are bound into rafts below the mills and rafted downstream.

(*b*) **Method of Landing and Storing Floated Wood.**—As soon as the wood has been collected in front of a boom, the measures taken for landing it must be arranged so that it may be brought out of the water as soon as possible. Whenever the depots are arranged so that the wood becomes stranded of itself (p. 433), the workmen must be stationed at the

various sluice-gates and gratings, and be instructed carefully in the manner of landing the wood.

Wherever the wood has to be dragged up to the depot, different methods of doing so are followed for sawmill butts and firewood. Butts are either rolled up the river-bank, or dragged up an ascending slope by horses or by machinery worked by the driving-wheel of a sawmill. Firewood billets are either spiked by a floating-pole and thrown upon the river-bank, or passed from hand to hand by a chain of workmen.

In some places machines are used for landing firewood. These machines consist of two horizontal rollers, one of which is alongside the water, and the other up on the bank of the stream. Two chains bound together link by link, and provided at short intervals with projecting iron hooks, are passed round the rollers; the billets of wood are then placed on these hooks, whilst the chains are set in motion by the upper roller; the hooks ascend the river-bank with the billets, which fall off as they reach the upper roller.* These machines are specially useful when the depot is situated on a high, steep, sloping river-bank.

3. *Methods of Storing Wood.*

The landed billets are conveyed to the stacking-yard in low tramcars or wheelbarrows, the round pieces being split previously; they are then stacked, beginning at a point in the depot the furthest removed from the water. In stacking, great care must be taken not to occupy too much space, to leave sufficient room for ventilation between the different stacks and erect the latter in a stable manner. With this object, the stacks of firewood are placed in long rows, in the direction of the prevailing wind, and made as high as their stability will permit. This is rarely higher than fifteen to eighteen feet. In erecting a stack, first the base is prepared as in Fig. 291, in order to keep

* On the river Ilz near Passau, there are ten of these machines which save 40 % of the former cost of manual labour for landing the firewood. 180 to 200 stacked cubic meters (100 to 140 loads) of wood can be raised thus in a day. At Hals, also on the Ilz, similar machines worked by steam-power are used for raising butts up to the depot, 8 meters (26 feet) high. Thus the heaviest kind of butts are raised.

the wood as much as possible from the ground and prevent its deterioration ; or merely two parallel lines of billets are laid on the ground, on which the wood is stacked. In the damper parts of wood-depots, especially in the case of large depots where there is not enough fall to allow the water to drain-off rapidly from the wood, and wherever the wood is stacked whilst still wet, this should be done as in Fig. 292.

Each stack must be finished off at both ends by crossing the billets to prevent it from falling. In very long stacks, it is advisable to place

some rows of crossed billets in their centre, so as to give more stability to the structure. In the case of very high stacks, the crossed billets at their ends should be connected by transverse pieces, as in Fig. 293. Between any two stacks there should be left a space of at least two feet, to allow for ventilation. Wherever, on account of scarcity of space, it is

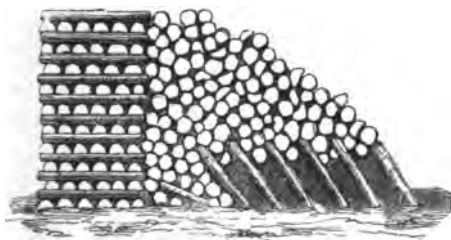

Fig. 292.—Stack of wet billets.

necessary to reduce the distance between the stacks to two feet, and the stacks are also high, two adjoining stacks are joined as shown in Fig. 293, which greatly adds to their stability. Wherever carts must pass between the stacks to remove the wood, a sufficient passage must be allowed between adjacent stacks for their passage. Not unfrequently, however, owing to want of space, four to six stacks are crowded together without any intervening space, as, for instance, at Prague, where the arrangement shown in Fig. 294 is followed.

Where large quantities of firewood remain stored for a long time at a depot, often a roofing of billets is supplied, as in

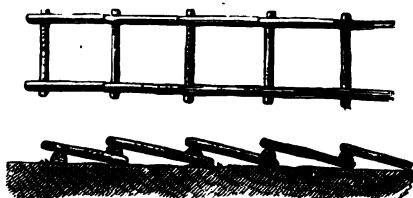

Fig. 291.—Base of stack.

necessary to reduce the distance between the stacks to two feet, and the stacks are also high, two adjoining stacks are joined as shown in Fig. 293, which greatly adds to their stability. Wherever carts must pass

Fig. 293. This excellent mode of stacking keeps the wood dry without any considerable cost. Wherever, in high stacking,

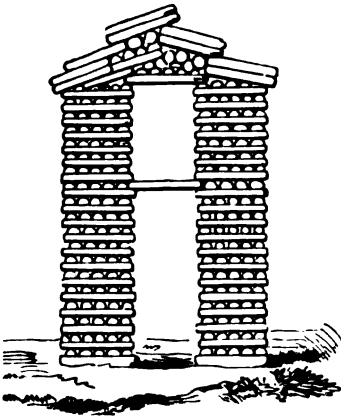

Fig. 293.—Roofed stack of billets.

the stack has become higher than a man's chest, stands must be used from which the billets may be handed to the stacker. This is especially the case with roofing. Evidently the billets should be piled as densely as possible, and the walls of the stacks made vertical. Many wood-depots in towns are intended to facilitate the sale of wood to small purchasers. In such cases the wood must be supplied in ordinary sale-lots. The stacks are then usually twice as high as the billets are long, and are separated by upright posts. measured separately for each purchaser. Whenever the sale of firewood is carried on in detail, it should also be sorted according to quality; this assortment of the wood is effected as soon as the wood is landed, the various pieces being brought together from all parts of the depot. When once the wood has been sorted and stacked, the stacks are numbered and measured.

Wherever firewood is piled in mixed stacks without separation into sale-lots, the measuring is done simply by taking the length and height of each stack; where the billets are crossed, a deduction must be made from the volume, the amount of this deduction being ascertained by experiment and

In other depots the wood is

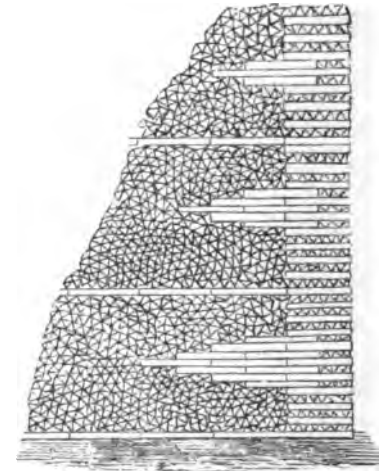

Fig. 294.—High stacking of firewood.

averaging the seventh or eighth part of the length of each stack. Wherever the firewood is arranged in sale-lots, its measurement consists simply in counting the latter.

4. *Registration of the Receipts of Wood at a Depot.*

It is quite obvious that in all wood-depots an account must be kept of all the receipts of wood both as regards volume and quality. The volume of the timber and of the stacks of firewood is ascertained in the usual manner. A further allowance has, however, to be made for the loss incurred during the transport of the material, which also naturally involves measurement of the wood before it was transported. Wherever wood has been transported carefully by land, the loss is either inconsiderable or absolutely nil, but when wood has been dragged over rough ground, or thrown downhill, etc., there may be a considerable loss of volume during transport. Loss during transport by water also may vary between 0 and 10 or 12 per cent. It is obvious also that the volume of the sunken wood which has been recovered should be deducted from the loss during floating, and that any losses occasioned by careless land-transport previous to floating must be excluded from loss due to floating alone.

The following circumstances influence the loss of floating wood:—the condition of the works on a floating-channel; its length; the kind of wood floated and its comparative dryness; the manner in which the wood is stacked in the forest, and in the depot; the question whether wood has been brought down to the launching place on slides or roads; also extraordinary occurrences such as floods, theft, etc.

CHAPTER VII.

DISPOSAL AND SALE OF WOOD.

THE disposal and sale of wood includes all the transactions by which wood passes directly or indirectly into the hands of the consumer. A distinction is made between the disposal of the wood, and its sale, as two questions are pending : to whom in the first place shall the wood be delivered?—then, how shall this be effected ?

SECTION I.—DISPOSAL OF WOOD.

According to the nature of the produce of a forest, the demands made on it, and the various intentions of its owner, different destinations may be given to the converted wood on a felling-area. The demands on the forest are of a double nature : they are either legal demands which limit the freedom of the owner in disposing of his produce, as in the case of forest-servitudes, contracts, etc. ; or the owner is absolutely free to dispose of the produce according to his own wishes. In the latter case the question arises, whether the forest-owner will be disposed to consider the requirements of residents in or near the forest ; or will merely study his own direct interests, a very different matter. It is obvious that in both these cases he will consider first of all what wood he requires for his own special wants.

As all these different modes of disposal of forest produce remain about constant year by year for a separate unit of forest management, there is generally no difficulty in subdividing the annual yield of a forest according to certain **fixed heads**, which must now be considered *seriatim*.

1. *Wood delivered to Right-holders.*

Wherever a forest is burdened with wood-servitudes, the right-holders have the first claim to the produce of a felling-area.

The legality of all claims for wood, as a right, must be proved first by reference to the map or record-book of the forest rights; this enquiry is often a serious business when the right-holders' wood has to be distributed in small lots among a number of persons. In such cases, in many districts, fixed days are assigned for the right-holders to attend the forest-manager and make a declaration of their demands. This declaration must be examined, rectified, and if needful referred to the superior officials for confirmation. Every delivery of wood to right-holders must be made on presentation of a written order from the forest-manager, and a receipt for the wood must be given by the right-holder.

If the right is to firewood, the quantity and quality of the wood being stated, the forest-owner is least seriously affected by the right; and in the next degree, when the right is to the kind of timber prevalent in the forest. If, however, the right is to all wood of a certain class, for instance, all branches and round billets, all the brushwood or stump-wood of a felling-area—if also the quantity depends on the manner in which the wood is converted and sorted—the distribution and supervision of the right-holders' wood becomes more arduous, and often involves complaints of short measure from the right-holders. Great care must be taken during the conversion and sorting of the produce; wherever also the dimensions of the right-holders' wood are given precisely in the statement of rights, this must be attended to carefully during the conversion. The most hurtful rights are those that are not fixed in quantity, but only by the requirements of the right-holders. If such rights to firewood should burden a forest and no legal definition can be obtained of their extent, an annual computation must be made of the volume required by each right-holder, or for each class of household. This burdens the manager with a tedious undertaking, beset with all kinds of difficulties.

Deliveries of building-timber to right-holders are of a similar nature. Such a right can be limited only to the actual requirements of the right-holder, according to the number and dimensions of the buildings in question. It is the duty of the forest officials to ascertain carefully the actual requirements of

material for repairs or new buildings, whenever a demand for building-timber is presented. If the demands of the right-holders are supported by estimates made by trustworthy builders the forest-manager is spared much trouble. Deliveries of wood for implements or industrial purposes are also arranged similarly.

2. *Wood delivered to Contractors.*

Frequently a forest-owner is under agreements, more or less binding, to supply wood to neighbouring industrial works; such as iron-foundries, smelting-furnaces, sawmills, factories for furniture, pyroligenous acid, wood-pulp, etc.; or to contractors or wood-merchants. Wherever the manager is bound to deliver a certain volume of wood to such establishments, their claims must be satisfied after those of the right-holders.

As a rule, except after some extraordinary calamity such as a storm, snowbreak, etc., the manager is not bound to deliver any fixed quantity of wood to a contractor; but an agreement is made, to deliver to a factory or a wood-merchant all the material over after satisfying the local demand, or all the wood of a certain class, such as round billets, etc. Whether or not a forest-owner should undertake such contracts, especially in the case of timber, depends chiefly on the market there is for his wood. In extensive forests which are not opened-out sufficiently by roads or other means of communication, managers of industries which utilise wood, and wholesale wood-merchants, are often the only purchasers; the forest-owner is then willing to submit to an otherwise burdensome agreement, in order to increase the forest revenue. Wherever there is a good competition for the wood, there can be no reason for contracting beforehand for its disposal. Not unfrequently, however, the possibility of a good sale of timber, even in the forest itself, depends on the maintenance of such industries, especially sawmills, which consequently do not reduce the prices of wood. This is due to the fact that sawmills favour the transportability of wood and convert it into actual merchandise. Even in this latter case it is advantageous to the forest-owner, who wishes to

support such industries in his forest, to bind himself only partially. Thus it is advisable to make contracts for two or three years only, and especially when trade is slack. Finally, in deciding the terms of a contract, great care and foresight must be shown by the forest-owner, or his interests will be prejudiced seriously, as long experience has proved. Wherever it is possible, the owner should not guarantee the quality and volume of the material to be delivered; if certain assortments are to be supplied, they should be only such as are prepared usually in his forest, otherwise it is better to abstain altogether from a contract.

3. Satisfaction of the Requirements of the Forest-Owner.

Every forest-owner requires wood for his own use, whether on a large scale or not; after satisfying the demands of right-holders and contractors; therefore he will consider what are his own requirements.

A private owner of forests requires firewood, building material and wood for gate-posts, fences, etc. If he owns any works, the wood necessary for them should be supplied also.

Municipalities and Communes owning forests require firewood for public offices, schools, etc.; they also grant firewood free of charge to school-instructors and ministers of religion; timber for repairing churches, public buildings, etc.; finally every household has to be supplied with firewood and building material according to its requirements.

The **State**, as owner of forests, may be expected to supply firewood and timber to meet the requirements of the Forest Department, of its mines and smelting furnaces, of the Public Works Department and other public bodies.

(a) **The requirements of the Forest Department.**—Wood is required for forest departmental purposes, for fencing nurseries, parks and lands occupied by forest officials, but especially for the construction and repairs of departmental buildings, woodcutters' huts, roads, bridges, slides, etc.*

* [All wood used in this manner should be shown separately in the registers of forest produce.—Tr.]

(b) **Wood required for Mines, Smelting Furnaces, etc.**—Where works of this nature are very extensive and require annually for their maintenance the yield of entire forests, it was formerly the custom to assign the management of a sufficient area of forests to the administration of the works, in order that the forests might be managed purely in their interests (such forests are termed in German, *Saalforst*, *Montanforst*, or *Reservatforst*). Experience has, however, shown that such an allotment of entire forests to mines, etc., has not resulted in any benefit to the forests; on the contrary, in some cases, they have been thus destroyed. Forests have therefore, recently, as in Bavaria, been withdrawn from the administration of the mines; the necessary wood is now furnished to them by the Forest Department.*

(c) **Wood required by the Department of Public Works.**—The requirements of the Public Works Department for rectifying river-banks, for railways and less frequently for public buildings, gave rise to similar assignments of forests (such as coppice for growing fascines) to that department, with this object in view. Experience has shown that it is disadvantageous to the State to deliver timber for building purposes to the public works officials from the State forests, the procedure being uneconomical and inimical to the State budget. Even forest buildings do not form an exception to this rule.

[As the French Navy has still the right of preemption of wood, chiefly oak, in the French State forests, a short account of the procedure in such cases will be useful. Royal ordinances dating from A.D. 1318 allowed the French Navy the right of preemption of wood in all the forests of France, whether private or otherwise, agents being sent by the naval authorities to mark trees in the felling-areas. This right continued up to 1838, when it was abandoned (with, however, the power of resuming it if necessary) in favour of purchasing the required wood in the open market. After the latter procedure had been in force for 20 years, the right of marking suitable trees in the State forests was resumed by the

* [A similar case is the Kumaon Iron Mining Company's Forest Grant, in the N. W. Provinces of India, which has been resumed by the State.—Tr.]

Navy in 1858. In 1866, rules regarding wood for the Navy were framed by the Forest and Marine Departments, and may be summarised as follows :—

Before the trees are marked for felling in any State forest, the agents of the Navy mark with a circle of oil paint any trees which they may consider suitable for naval construction, in compartments where fellings are in progress. These trees are then marked for felling at the usual time and in the same way as the other trees in the felling-areas, but with special marks. All the marked trees are sold standing, as is usual in France, but the purchaser pays only for the crowns of trees chosen for the Navy, excluding any boughs which have been specially reserved. He then fells all the trees, but a naval engineer examines those stems which had been specially marked for the Navy and then proceeds to convert them into the necessary pieces and remove them to a sea-port. The price is fixed for a period of five years at so much a cubic meter, and a current account kept between the Navy and Forest Department. Boppe, *op. cit.*, p. 228.—Tr.]

(d) **Wood required for Floating-Channels and Wood-Depots.**—Formerly it was considered the duty of the State to maintain large firewood-depots in districts where there were no forests, and to convey the wood there at its own charge. In order to carry-out this object a special floating department was organised, to which the necessary volume of wood was delivered from the German State forests. Since means of communication have been extended and with them the trade in firewood, the necessity for the department has disappeared, and it has been abolished.

(e) **Wood required for Sawmills.**— There are several German States and Communes owning sawmills, the management of which is more or less independent of the Forest Department. (For instance, Brunswick, Alsace and Lorraine, Hanover, Baden, etc.)

(f) **Wood given to Privileged Persons (*Deputathölzer*).**— Under this heading comes wood given as part of the salary of Government servants; in some States, as in Mecklenburg, inferior firewood is given gratis to the poor.

Special orders are given by superior authority to the local

forest officials as regards the delivery of wood of the different classes referred to above.

4. *Disposal of Wood by Sale.*

All wood which is not required under any of the above headings will be sold. The next section describes the different modes of sale, the only point of interest here is into what hands the wood should come after being sold. A distinction is thus made between satisfying local demands and sale of wood to traders.

(a) **Satisfaction of Local Demands.**—Care for the protection and tending of his forest often will lead a forest-owner to consider, first of all, the requirements of people living in or near the forest. As this can be done only to the extent of their own absolutely necessary requirements, it will suffice, if, as a rule, the less valuable assortments are set-aside for this purpose; usually only inferior assortments of firewood and building timber are sold thus in a market limited by the exclusion of wood-merchants. Whether or not the State will undertake to satisfy local demands on a large scale depends on its vacillating interpretation of the laws of national economy.

(b) **Sale of Wood to Traders.**—The sale of wood to meet local demands is opposed to its sale to traders, as then an open market is understood. When once a forest-owner has satisfied local demands, his desire to sell the rest of his produce at the highest price attainable is distinctly to the advantage of his forest. It is chiefly the best timber and wood with which the forest-owner can speculate that can be exported with profit to a distance. For very many forests the mode of treatment and conversion depends on the timber-trade, and many forests can be worked only with the help of the wood-merchant, local demands being small and easily satisfied. Disposal of wood for trade purposes is therefore in most forests the most important mode of utilising them.

5. *Loss of Wood.*

Cases occur where wood already registered as received may be lost, for instance, by fire, theft, etc. The possible loss of wood is therefore a mode of its disposal.

SECTION II.—SALE OF WOOD.

Wood, like every other raw material, is an object of trade and is sold in various ways, the *pro* and *contra* of which will be described here. As, moreover, every forest-owner desires to obtain the highest possible revenue from his forest, and this is chiefly determined by the price he obtains for his wood, the question arises as to the general trade-principles governing the sale of wood, in order that this object may be attained. The modes of selling wood may be distinguished in two ways: first, the form in which the wood is offered for sale by the forest-owner; secondly, the different kinds of sale, depending on the manner in which the price is determined.

1. *Form in which Wood is Sold.*

Wood may be sold either by detail after conversion into logs, stacked firewood, etc.; or by standing trees.

(a) **Sale by Detail.**

Sale by detail follows after the felling, conversion and removal of the wood to a forest-depot, which operations have been effected by a body of woodcutters engaged for the work by the forest-owner. The wood is sold in larger or smaller lots, or by the whole volume of certain assortments, according to the kind of sale in question.

Sale by detail is the most rational mode of sale, as the lots have been estimated in quantity and quality and their value can be determined accurately. It presupposes, however, the certainty of recovering from the purchasers all the cost of felling, conversion and removal of the material. Wherever there is a fair demand for wood, this is the usual mode of sale in Germany, Austria, Hungary, Switzerland and some other European countries.

(b) **Sale of Standing Trees.**

The sale of standing trees involves the sale, or at least, the fixation of the price, before the wood is felled. This may

imply the sale of the fall of timber on a felling-area for one year, either by single trees, or by a part or the whole felling-area; or of the principal yield of a forest for a term of years. Where the fall of timber during a single year is sold, two methods are in force, according as the felling and conversion is done by the owner, or by the purchaser.

i. Sale by Unit of Produce.

Sale by Unit of Produce implies either that the felling, conversion and clearance of the felling-area is done by the forest-owner, or by the purchaser (as in France); in the first case it closely resembles sale by detail, differing from it only in the fact that the prices are fixed for each wood-assortment before the trees are felled, also that the purchaser contracts to pay at rates previously agreed upon for all the wood of the assortments he has bought.

Such sales are at present frequent in Germany, Austria-Hungary, Switzerland, France, etc. They extend usually to the produce of a whole felling-area, and the fellings may be of any character, as neither silvicultural interests nor the revenues of the forest are prejudiced by the mode of conversion. As the prices are fixed separately for each wood-assortment, and for different classes of assortments by the unit of cubic contents (cubic meter), an approximately correct estimate of the real value of the yield is secured. When experience of the results of former fellings does not guide the owner (by taking percentages) as to the volume and quality of the crop, the probable produce from each tree should be calculated separately, and an estimate thus made of the volume and quality of the yield of the whole felling-area. It is, however, evident that no guarantee should be given to the purchaser of the exactness of this estimate.

Where this mode of sale is applied to single trees (as, for instance, large oak-trees) and not to entire felling-areas, a better forecast of the real value may be obtained.

[In France, where the conversion is done by the purchaser, all the wood cut and converted is measured by the manager or his forester before it leaves the area.—Tr.]

ii. *Conversion by the Purchaser.*

When trees are sold standing and the purchaser undertakes their conversion into timber and firewood, if the seller and purchaser are not to be quite in the dark as to the real value of the trees, a much more careful forecast of the yield should be made than in sales by unit of produce; if this is not thoroughly well done, the forest-owner will certainly come out of the business at a loss.

These sales may deal with **all the standing trees on a felling-area** or on a demarcated portion of a felling-area. In such cases, the estimate of their value depends on an accurate survey of the area, and a calculation of the average yield of an acre, which is possible in the case of homogeneous woods, such as pure coniferous even-aged woods, or coppice. Then care must be taken, in case experience of the yield of similar fellings is not available, to make use of every assistance which the different methods of valuation can afford. Generally, in Russia, crops of standing trees are sold **by area** [and so is coppice in England.—Tr.]

If, however, the sale is only of certain **marked trees on a felling-area**, the protection and tending of the forest may be endangered much more than when the sale is by area. This is specially the case in regeneration-fellings or fellings by selection, and in those of trees standing over poles. This mode of sale may, however, be applied advantageously to standards over coppice, or to isolated large trees in middle-aged high forest, or in forests where the trees are far apart, as in Russia. It is more admissible for conifers than for broad-leaved species, as the real value of the former may be forecast more accurately than that of broadleaved species, which so frequently suffer from internal defects.

Here and there, material of little value, the conversion of which would prove too costly for the forest-owner, may be sold *en masse*, such as stunted wood on waste land, inferior pollards, stumps of trees which are difficult to uproot and split, etc. A purchaser who estimates his own labour at a low value may find a profit in purchasing such material.

iii. *Lease of the Yield of a Forest for a Term of Years.*

The two preceding modes of sale involve the sale of only one year's fellings in a forest, but not the lease of the annual yield of a forest for a term of years. This was formerly almost the only mode of sale in the vast Austrian mountain-forests. During the eighteenth century, nearly all extensive works using wood obtained the assignment of adjoining forests for their exclusive use, sometimes with the sole stipulation that the management of the works should remove all the trees in a forest during a rotation, on undertaking to pay all the costs of maintenance of the forest. This privilege was termed *Kohlwidmung* (charcoal concession), and implied the right of the works to take so much charcoal annually from the forest. Such concessions of forest produce are made no longer, but leases of forests for terms of three to ten years still prevail, chiefly in Russia, Sweden, West and East Prussia, in some provinces of Austria-Hungary (Moravia, Bohemia, etc.), Switzerland, etc. The price is then fixed by formal, written agreement. Some of the older concessions are not yet abolished, in spite of repeated endeavours on the part of the German Forest Departments and of private forest-owners.

iv. *General Remarks.*

The chief point to be observed in all sales of standing trees is to decide the requisite silvicultural and protective conditions and to word them clearly; a thoroughly detailed description of the material to be sold should also be given. In France, lists of trees to be sold standing are published in pamphlet-form giving all the sale-lots on the felling-areas of a single forest range (*inspection*) for a whole year.

[In these French lists, besides the number and species of trees in each lot and their cubic contents in timber and fire-wood, a list is given (*cahier des charges*) of all the protective works to be done at the expense of the purchaser, such as pruning, planting-up blanks, repairs to roads, etc., together with estimates of their cost. Strict general silvicultural and protective rules for the conduct of the fellings also are printed in each pamphlet.—Tr.]

In Austria, also, much acuteness has been shown in devising the conditions of sale of standing trees.

2. *Various kinds of Sale.*

Three kinds of sale of forest produce are in use, which depend on different methods of fixing its price, namely, **sale by royalty**, **sale to the highest bidder** and **sale by private contract**.

(a) **Sale by Royalty.**

Whenever wood of any assortment is sold at rates fixed by the forest-owner, the mode of sale is termed **sale by royalty**, or **sale at fixed rates** or **tariff-prices**. The characteristic of this mode of sale is that the price is fixed by the seller, the forest-owner providing for the distribution of his forest produce among its consumers.

i. *Mode of fixing the Royalty.*

By the term **royalty** is meant the present local value, in a forest-district, of any wood-assortment, as it is determined by the free action of demand and supply in the timber-market and in auction-sales. The royalty for any assortment is determined by taking the average price during a recent period for all similar wood sold within a certain district. The larger the volume of wood sold in the open market, and the narrower the limits of time and place within which the average price is fixed, the more nearly will the royalty correspond to the correct price of the assortment.

Formerly royalties were fixed on quite different grounds from these. Up to the end of last century it was considered advisable—and in some countries this is even still the case—that the State, at any rate, should sell the produce of its forests at moderate rates to the people. Royalties therefore were kept low purposely, so much so, that they were considerably under current local prices; they formed the minima margins of the prices of forest produce.

Royalties were fixed for a district by making benevolent estimates of prices, after considering the area of the district

that was under forest, the economic condition of the population, the cost of transport, and, finally, the different qualities of the wood-assortments. It was, therefore, a mere stroke of luck if the royalty was anywhere near the correct price of an assortment. How little, indeed, this was the case, may be gathered from the fact that often royalties were fixed for entire provinces or small States, and frequently remained unaltered for long periods. If the forest officials desired to counteract these bad results to some extent, they had to propose an increase in the royalties for certain special cases, and thus attempt to reform an evil by imposing a greater one. This system did most damage in Austria, where certain State and private forests were assigned to mines of salt and other minerals, supplying them with forest produce at prices which were for the most part ludicrously low, often so low as to cover barely the cost of maintaining the forests. In this way, forests were deprived of their proper revenues, and their maintenance and development were hindered unfairly.

The great harm done to forests by low wood-prices, the rising value of all raw material, the constantly increasing demands on State treasuries and the many inconveniences resulting from the above antiquated ideas in the sale of forest produce, have, in most countries during the second and third decades of the present century, led to a complete change of principle. It is now admitted that the forest-owner, like any other producer, is thoroughly justified in selling his produce for its full value.

Even if there can be no question that the price of firewood depends on that of coal, yet to depress it as low as that of coal merely on this account is not fair, for there are several other intervening circumstances which must not be neglected, such as custom, comfort, etc.

The price of wood varies with time and place, and in order to allow due weight to these factors in fixing royalties, different tariffs must be assigned to different districts or sale-depots. Thus, all places where wood prices are about the same should be comprised within a sale-district, excluding places where there are any marked differences in prices. In a province,

district, or forest-range, therefore, there will be as many tariffs as there are market-values for the same wood-assortment. But even the very points which have occasioned the separation of sale-districts from one another may themselves vary, and render it necessary to alter the circumscriptions of the latter. In a similar manner allowance is made for periodic variations in wood prices, by revising the tariffs whenever a general rise or fall in prices has occurred. Owing to the present changeable nature of trade this should be done almost every year, at any rate for sale-districts within the reach of the general trade in wood. As regards very valuable wood-assortments, tariffs should be revised even more than once a year, whilst for inferior assortments, longer intervals, from two to three years, will suffice.

Where most of the annual yield of a forest is sold to the highest bidder, tariffs are prepared for the ensuing year by taking the average sale-prices in round numbers for each assortment, due allowance being made for any abnormal circumstances affecting particular sales, or for assimilating the tariffs sufficiently to those in force in neighbouring sale-districts. Whenever the average results of sales to the highest bidder do not afford sufficient data for framing tariffs, the market-prices of wood in neighbouring towns should be utilised also, naturally after deducting the cost of transport from the forest depots.

In many cases the forest-range will suffice as a sale-district. It may, however, be necessary to subdivide a forest-range into two or more sale-districts, *i.e.*, to fix several tariffs in a range according to the different directions in which the produce is distributed. This is generally the case with ranges situated on the borders of extensive forests, or composed of widely scattered isolated forest blocks, and where considerable differences of prices result from different transport charges. In high mountain-regions, especially the Alps, tariffs will depend on the altitudes of different zones of forest; thus, the lowest zone, including the valleys, may form one sale-district, the middle zone, another, and the highest forest zone, with Alpine hamlets, cheese-factories, etc., the third.

As a rule, royalties include the cost of conversion and

removal from the felling-area. In districts where the conversion and removal of the wood is done partly by the purchaser, two tariffs will be in force, including or excluding the above charges.

ii. *Application of the Method of Sale by Royalty.*

There are districts where, in consequence of admitted rights, almost the whole annual yield of forests in firewood is disposed of by royalty, either at a full or reduced value; in other districts this happens in the case of only a portion of the yield and no further than sheer local necessity requires. In most cases, however, sale at tariff-prices has receded quite into the background, and is confined to: cases of **unforeseen distress**; **wood-assortments which cannot be sold to the highest bidder**; **inferior lots**, the sale of which will not repay auction charges, or **rare assortments** of specified kind and shape; also, finally, in some districts, to the **requirements of the forest officials**, who are not allowed to bid at auctions.

In country districts, it is chiefly wood for agricultural requirements, such as bean-sticks, tree-props, etc., which in cases of considerable demand should be sold by royalty, as in this way theft may be prevented.

It may be imagined, since sale by royalty is at present generally the exception, that the fixation of a correct tariff is a matter of only second-rate importance. This is, however, not the case, for a continual knowledge of the actual value of forest produce is advantageous in many ways. Royalties are the best means of deciding the acceptance of offers to purchase wood, or when to knock-down lots to bidders at public auctions; they afford a means of estimating the value of stolen produce; they are indispensable in every kind of forest valuation, and in calculating the value of forest rights, damage, sale of forest land, or other similar questions, and finally in calculating budget-estimates and other statements.

Royalties are evidently useful only when they represent the actual momentary local value of wood, *i.e.*, its average market price for the time being. Unless this can be affirmed of them

they are absolutely worthless. It must not, however, be forgotten, that royalties also possess the character of **prices fixed by authority**, and thus often exercise an influence on market prices that is not always justifiable.

(b) **Sale to the highest Bidder.**

The next mode of sale to be discussed is, when a purchaser offers his wares for sale to the highest bidder in the presence of a larger or smaller number of purchasers. The characteristics of this method are, that the price is fixed by the purchasers, and the wares, *i.e.*, the forest produce, is divided among the consumers according to their own requirements and without direct interference on the part of the forest owner.

Sale to the highest bidder may be effected by **public auction** or **sealed tender**.

i. *Sale by Public Auction.*

(a) **General Account.**—Public auction-sales may be conducted either by the purchasers out-bidding one another, or by putting up each sale-lot at a prohibitively high figure, a public crier then calling out at regular intervals successive reductions by a fixed sum of this figure for any lot, until one of the purchasers signifies his acceptance of the lot at the last figure proclaimed by the crier. This latter mode of sale is termed a **Dutch auction**, and in case two or more purchasers accept a lot simultaneously, it is put-up for sale to the highest bidder among them.

Sale by successively increased bids is the common mode of auction-sale in Britain, Germany, Austria-Hungary, Switzerland, etc., whilst Dutch auctions for forest produce prevail in France, Belgium, Holland, Alsace and Lorraine.

Dutch auctions for forest produce are employed generally only in the case of valuable timber sold in large lots, and when only a few purchasers are present who are men of means; they are preferred in Alsace. Wherever wood is sold in small lots to a number of small purchasers such a method would be out of place, for the following reasons: it takes much more time than when purchasers outbid one another; where there are a

large number of purchasers assembled, only a few of them will have the requisite presence of mind to make a bid at the right moment; customary usage may be against this mode of sale.

[Dutch auctions are preferred in France in the sale of standing trees in the principal fellings, because there are a body of large contractors, termed *adjudicataires*, who make it their business to purchase the marked trees standing on a felling-area, and convert and remove them for sale to smaller dealers or industrial enterprises. These men visit every felling-area within their beat, measure and estimate the value of every marked tree; they know exactly what amount they can afford to pay for the trees and bid accordingly. French foresters consider that Dutch auctions prevent the purchasers from agreeing not to out-bid one another; a purchaser cannot know beforehand at what figure any other purchaser will buy, and therefore dare not delay too long in his offer to purchase, fearing lest the lot should fall to another person. In France, the felling-areas are subdivided into lots, which are marked out on the ground: no lot should exceed 10,000 francs, £400, in value.—Tr.]

(b) *Procedure in Auction-Sales of Wood.*

When once the mode of disposal of the produce of a felling has been decided, the wood that is to be auctioned should be carefully valued without loss of time. Then the date of the auction should be fixed, and this, as well as the place where the auction will be held, and the list of material to be sold, should be advertised publicly. The procedure of the auction itself begins by an announcement of the conditions of sale made to protect the seller against injury or loss, the lots are then put-up successively at the fixed upset-price and knocked down to the highest bidder; the highest bid is therefore the price of each lot. As soon as the last lot has been sold, the auction is concluded by ascertaining the total price paid for each wood-assortment and for the whole of the produce which has been sold.

The success of the auction will depend in some measure on

the place where it is held. This may be either on the felling-area or at the wood-depot, or in a building in some neighbouring and suitably situated village or town.

If the sale is effected in the forest or depot, then every would-be purchaser can examine each lot, and estimate its value, and bid for it with confidence and deliberation. This is particularly useful for purchasers when there is a considerable difference in the quality of the various lots.

When, however, in a sale by detail the lots are scrupulously assorted as at present in many forests, the buyers are accustomed to visit the felling-area before the sale, and true descriptions of the lots are given by the auctioneer—or where in sales of standing trees sufficient information regarding their volume and quality has been supplied beforehand to the buyers—a sale under cover of a roof is preferable, as it is much more expeditious and usually attracts a greater number of purchasers than a sale in the open air. Anyone wishing to purchase a large quantity of timber, will in any case visit the felling-area before the sale, and small purchasers have no time during the sale to measure and value every log, without delaying the auction intolerably. An auction in the forest is therefore advisable in the following cases: when buyers cannot be induced to visit the felling-area or depot beforehand; when the wood has been assorted carelessly, or each lot contains wood of various assortments and qualities. Generally, in all other cases, the interests of the forest-owner are safeguarded better when the auction is held in a building.

The date chosen for the auction, the place in which the auction is held, and the list of material to be sold, should now be advertised publicly, both in the best local newspapers and in printed notices posted up at inns and public buildings in the sale-district, as well as by the public crier. If the produce to be sold is chiefly wood for local demands, it is superfluous to spend much money on advertising; it is then sufficient in the notices to give a list of the chief assortments, and to advertise in purely local newspapers only. If, however, valuable timber is to be sold for which there is a good demand or which is suitable for export, or in sales of large quantities of merchantable firewood and especially of

standing trees, the sale-notices should be more widely published. In such cases the forest-manager should select the best newspapers for his advertisements, and too much economy would be out of place. Whenever purchasers from a distance may be expected, they should be informed by advertisements of the chief conditions of the sale.

Whether the sale should be conducted by Forest or Accounts officials, depends on the special administrative arrangements of different countries. Although unnecessary expense in this matter cannot be justified, it is, on the other hand, undesirable to leave all responsibility for the sale to the Forest Department. The Accounts officials are, in any case, better acquainted with the buyers than the foresters and should therefore be responsible for their solvency; this is the case in Prussia, where the Forest Accountant attends all State forest auctions.*

The auction commences by an official reading out and explaining the conditions of sale. These include: a statement whether the sale is with or without reserve; the terms of security for payment to be offered by the purchasers; conditions under which unknown strangers are allowed to bid; measures of security against a conspiracy among the buyers to keep down prices; dates of payment, and limit to which credit is given; a list of roads by which the wood may be removed, and the conditions of removal; special political and silvicultural conditions which are considered advisable; finally, that no complaint will be entertained as regards any lot after it has once been knocked down.

The upset-price at which the lots are offered for sale must evidently be less than that expected from the purchaser. How much lower it should be is a question not without importance as regards the obtainable price. Too high an upset-price frequently prevents the purchasers from bidding freely; when too low, it causes delay, and if the competition is limited, leads to inferior prices being obtained for the wood. Although

* [In France, the *Préfet* or *Sous-préfet* presides at State forest auctions. In Belgium, sales of standing trees in private forests are conducted by a *Notaire*, or notary public, who charges 11% commission, 3% of which is a State tax, and guarantees the solvency of the purchasers. In France, the charge is 15%.—Tr.]

local circumstances, the social condition of the purchasers, their number, and several other matters, may influence the choice of an upset-price; in most cases, it should be 10 to 20 per cent. under the royalty or real value of the wood. In the case of valuable merchantable timber, the upset-price may be higher, and even equal to the royalty when there is a probability of eager bidding. In the administration of some State forests (Saxony and Baden), the practice of fixing an upset-price to the lots in proportion to the royalty has been discontinued; unrestricted bidding being considered more advantageous to the owner, as well as to the buyer.

Every sale-lot should be clearly designated in the sale catalogue by its number; the assortment, volume or dimensions of the wood, and any other particulars which are advisable being given. In important timber-sales, intending purchasers should be allowed, before the sale, to consult the felling-register, or facsimile extracts from it should be handed round. In sales of standing timber, ready assistance should be given to enable purchasers to obtain knowledge of their value. The amount of the highest bid for each lot, with the purchaser's name, is then entered in the auctioneer's report, or in the felling-register. This is often attested by the purchaser's signature and that of a trustworthy surety. In sales by detail, after the last lot has been sold, the price of the different assortments is totalled and the average price of each assortment calculated, so that it may be decided whether the confirmation of the sale may be at once effected, or must be postponed, in case the average prices of the assortments are under the royalties* at which the forest official is authorised to sell the wood. In case the prices are lower than the authorised minima, either they must be confirmed by superior authority, or a fresh sale held.

* A sale may be confirmed in Baden, when the average price offered is not less than 10% lower than the average price of the last sale in a neighbouring forest range. In Prussia, the *Oberforster* can confirm a sale, if prices are not 20% lower than fixed royalties. In Bavaria, the *Forstmeister* sanctions annually the percentage by which sale-prices may fall below royalties (for timber, generally, 10%, firewood 15%).

(c) Delivery of Wood to the Purchasers.

The sale having been confirmed, the wood of the different lots is delivered to the purchasers immediately after the sale, unless there is any difficulty in furnishing security for payment. If the sale is held in the forest, this is done either by handing over the wood at once, or by giving each purchaser a written order of removal for the wood he has bought. When sales are not held in the forest, the forest-manager assembles all the purchasers at the felling-area or depot, on a day fixed as soon as possible after the sale, and shows each purchaser his wood. Either then, but generally at the auction, each purchaser obtains his **permit to remove** his wood, on which is stated: the place where the wood is lying; a sufficiently clear description of the wood sold; the price to be paid for it and sometimes the dates when payment should be made. This permit should then be taken to the forest cashier and the price paid to him, when it is returned stamped and receipted, and then the purchaser can remove his wood. When credit is given, and payment is therefore not immediate, the cashier should notify to the forest-manager the names of any purchasers regarding whose solvency he has any doubt; in such cases, the wood must remain in the forest until payment has been made or satisfactory security provided.

Sometimes a period of time is fixed during which the forest manager is responsible for the safety of the purchasers' wood lying in the forest.

As a rule, however, wood once sold and delivered to the purchaser remains at his risk after he has received the permit for its removal, although the forest-guards are expected to watch it carefully and prevent fraud. In many districts—as, for instance, in the Rhine-valley—the forest-owner declines all risk for the sold wood, but a special guard is appointed and paid for by the purchasers for one or more felling-areas, to protect their wood when lying in the forest. A fixed rate of payment is then allowed for every stack of wood, every log and every hundred faggots, which is paid to the guard by each purchaser on the removal of his wood. Generally this institution of a guard for felling-areas is agreed to tacitly by all

purchasers of wood. Usually, the men who stack the fire-wood also guard the felling-area, for they can carry on these double duties conveniently.

ii. *Sale by Sealed Tender.*

The other mode of sale to the highest bidder is that in which, after public advertisement of a sale, the offers or tenders to purchase are written and submitted in a sealed cover to the seller. In the case of a sale of standing trees, the written tenders to purchase may be either for the produce of a whole felling-area, or for separate lots; in both cases a valuation in volume and by assortments of wood is presupposed. If the wood to be sold has been converted, it is sold generally in assortments, or classes of assortments, usually by the purchaser tendering so much per-cent. more or less than the upset-price (say, 2, 5, 10 per cent. over, or under, the usual royalty). All tenders which have been received are opened on a fixed date and hour, in the presence of the intending purchasers. They are read out publicly, and each lot awarded to the purchaser who has submitted the highest tender, provided he can give good security for payment.

Just as the solvency of the persons who tender for the wood must be assured, so other motives such as silvicultural requirements may influence the sale. As a rule, however, the sale is confirmed to the highest bidder. As in sales by public auction, it is highly in the interests of the seller and an absolute right on the part of the purchaser, that before tendering he should have free access to the sale-lots, and, on demand, should be allowed to see the report of the valuation of the wood and the felling-register.

(c) *Sale by Private Contract.*

When an owner deals with a single purchaser, and the price is fixed after a discussion between them, a sale by private contract results. This mode of sale is characterised by the fact that the price is fixed by both buyer and seller.

In arranging the price, the owner will be guided generally

by the average results of past sales to the highest bidder (or in certain cases may accept this figure as the price).

Sale by private contract has the advantage of saving expense in valuation and auction-charges, and in avoiding possible loss. At the same time, it is clear that the seller undertakes a greater responsibility than in any other mode of sale, and must have a precise knowledge of the actual state of the wood-market for the time being.

3. *Comparison of the various Modes of Sale.*

Each of the above methods of selling forest produce is advisable under certain special circumstances; it is better that a forest-manager should not be wedded to any one of them, but that he should be ready at any time to adopt whichever method may prove most suitable for the case in question.

(a) **Sale by Royalty.**—Sale by royalty has the least claim of all to exclusive adoption or even preference, as has been shown on p. 454. Only in some places, in the case of certain privileged demands for wood, is such a method followed exclusively, and then the formation of a proper tariff requires great care. Where, on the contrary, sale by royalty is adopted only occasionally, it forms a useful supplement to other modes of sale. It has then the advantage, in cases of necessity (conflagration of a village, scarcity of wood for agricultural purposes at seasons when the principal sales are not conducted, etc.) of satisfying urgent demands. Also, when traders combine to keep the price of forest produce below its full local value, a recourse to sale by royalty may improve matters.

To adopt sale by royalty generally and exclusively would at once exhibit the shady side of this method, and prove that it is almost impossible for a forest-manager to acquire an accurate knowledge of the real local value of wood. If also it were argued that prices may be corrected by the competition of sellers, a reply may be made that forestry is less able to effect such a result than any other industry, the forests in any district being usually in the hands of one or only a few owners

(b) **Sale to the highest Bidder.**—Sale by public auction, provided that enough competitors are present, may be considered as the most usual mode of sale. The chief advantages and disadvantages of its different varieties are as follows :—

i. *In Sale by Detail.*

When converted timber is sold in small lots by public auction, sufficient competition will ensure the best prices, for owing to demand and supply prices in this case most nearly represent the true local value of any sale-lot, including its quality, utility, portability, etc. By auctioning forest produce, it is distributed among the consumers in the simplest manner, and according to the measure of their requirements. If there are exceptions to this rule, they are less numerous and remedied more easily than in sales by private contract. Much less time is occupied in auction-sales than in sales by private contract, a matter of great importance. All unjust dealing and respect for persons which may easily occur in private sale, or complaints of which may be brought against the most honourable foresters, are avoided by public auctions. The superiority of public auction over sale by private contract is proved by the fact that nearly everywhere in Germany, sale by private contract has been supplanted by auction-sales.

Amongst the disadvantages urged against sale by public auction, the following is worthy of notice, namely, the possibility of the purchasers coming to an understanding before the sale. This is especially to be feared—when the attendance at a sale is small; when too much material at a time is offered for sale; in the case of wood-assortments that not everyone can buy, either because their cost is prohibitive or the demands for them are small; or finally, when the seller purposely tries to maintain prices above their proper local figure. Coalitions of purchasers are very frequent in the sale of merchantable timber, rafted wood or firewood intended for trade, for which local competition may be nil, or of a very limited nature.

Coalition of purchasers is becoming a common affair in Germany, being much more frequent than is imagined, both at

large and petty sales. The theoretical idea of an auction-sale involves the assumption that every competitor is present merely on his own account, and that a coalition among the competitors is impossible: coalition cannot, however, be prevented, provided it is agreed upon freely by the competitors; it is illegal only when brought about by threats, etc. The seller must, therefore, endeavour to guarantee himself against the damage he may suffer owing to coalition at auctions. Almost the only remedy available is to stop the sale, and adopt measures to improve the competition of purchasers. Among these are the following: advertising widely (this, however, presupposes sufficient wood to attract distant purchasers); sub-division of the sale-lots into smaller ones, so that it may be possible for poorer purchasers to compete; finally, avoidance of all burdensome sale-conditions that reduce competition. A further measure against coalition is to adopt another mode of sale. [A common method of prejudicing sales by auction occurs in Britain and probably elsewhere. As soon as the sale-catalogues are out, timber-merchants meet and appoint a chairman, who acts as a private auctioneer and puts up each lot to the company present; they then run it up to a fair market-price. At the real auction, afterwards, the purchaser is not opposed by any of the clique and has only the competition of a few outsiders to contend with. After the real auction the clique meet and divide among themselves the difference between the real and mock auction prices, very often a considerable sum practically taken from the forest-owner.—Tr.]

There are also first principles of justice as well as of self-interest, which should always induce the seller to avoid all conduct on his part which may hinder a proper price being paid, or lead to coalition of the purchasers.

ii. *Sale of Standing Trees.*

The sale of standing trees, especially with the right of felling and conversion by the purchaser, is preferred frequently by wood-merchants and large dealers in timber to that of converted wood. This is explained easily by the fact that in the former case the wood-merchant can convert and remove

the wood more profitably to himself, and can time its conversion and removal so as to take advantage of any special demand. In this mode of sale, however, the purchaser obtains the crown and stumps of the trees, as well as the stems, and thus may be encumbered with a quantity of firewood, the disposal of which is often burdensome and unprofitable to a timber-merchant.

The matter has a different aspect as regards the interests of the forest-owner. When the standing trees are sold by unit of produce, this protects the forest-owner from the necessity of selling his trees at too low a price, at the same time allowing him full play in felling and converting the trees carefully. When, however, it is important to satisfy local demands, this mode of sale is not satisfactory [as the whole of each assortment from a felling-area, or the demarcated portion of one, is purchased necessarily by one individual.—Tr.]

Sale of standing trees to be felled and converted by the purchaser is generally more disadvantageous than otherwise to the forest-owner, since he is obliged to hand over the felling-area more or less to the purchaser, and is unable to effect an accurate estimation of the volume or quality of the wood, a condition which is generally more unfavourable to the seller than to the buyer. It is well-known what large profits are made by wood-merchants in the purchase of whole forests, or compartments, of standing trees in Russia, Bosnia, Hungary, etc. Still, under certain circumstances, the sale of standing trees may be preferable to that of converted wood, especially when the wood-market is over-stocked; when supervision is defective or labour scarce; also in districts where this mode of sale has become customary, and long usage, influenced by the interests of both buyer and seller, have removed much of its harmfulness.

Experience of the sale of standing trees has shown, especially in Russia, where this mode of sale prevails, and also in France* and Austria, that in many cases silvicultural

* [Generally the attention to silvicultural requirements on felling-areas in the French State Forests on the part of the *adjudicataires*, or purchasers of standing trees, is satisfactory. In thinnings, where all the trees to be removed cannot be known beforehand, but are marked gradually as the work progresses, sales in France are effected by unit of produce.—Tr.]

requirements cannot be safeguarded to the extent that is desirable in regular forest management, even after specifying most carefully the conditions of sale, and with the best possible supervision. In extensive forests, and where the regeneration and culture of a forest nowise depends on the mode of utilisation (as in clear-cuttings), there is no objection to the sale of standing trees. If, therefore, silvicultural considerations do not intervene, it may be to the advantage of a forest-owner to adopt this method temporarily under certain circumstances. Such circumstances are: persistent coalitions of competitors at auctions and scarcity of labour, for wood-merchants can often engage wood-cutters more cheaply than the Forest Department. Since a wood-merchant with foremen attached to his interests is more in touch with the whole business than the distant and often impersonal forest-owner, the felling, conversion and assortment of the produce of a felling-area is effected with more zeal and skill, and sometimes a finer finish is given to what would otherwise be merely rough conversion.* Finally, in the case of extraordinary quantities of produce, owing to damage by storms, insects, etc., when the trees may be considered as only partially standing, it may be more advantageous to the owner to sell the trees on the whole affected area to a wood-merchant, than to convert it by the help of his own wood-cutters, and sell the material by detail.

As regards State forests and those belonging to corporate bodies, the question between these two modes of sale has another bearing. Generally the forest official should pay maximum wages for felling, conversion and removal of the wood. When, however, in State forests, from short-sighted financial economy, wages are kept so low that even the industrious wood-cutter can hardly earn a living wage, the

* [In the Himalayan forests, export-works involving a large expenditure are required in order to work the forests economically and profitably, and the trees are converted into railway-sleepers or firewood; it has therefore proved more profitable, after agreeing beforehand with a railway or the commissariat department for the sale of the produce, to convert the trees departmentally rather than to sell them standing to purchasers, who are accustomed to work out standing trees from forests of native chiefs without any silvicultural restrictions.—Tr.]

work he effects must decrease both in quantity and quality, and he loses all interest in the well-being of the forest. The rich wood-merchant who undertakes to fell and convert the trees on a felling-area usually pays high wages, as his interest is bound-up with careful conversion, etc. That he considers this expense in the price he pays for the trees cannot be denied. In such cases, evidently the general welfare is secured better by selling the wood standing than by converting it departmentally, the balance falling the other way for the forest-owner. An example has been cited here merely to show that there are many factors affecting the question in any special case.

Sale by sealed tender should be employed for standing trees, or in sales by detail, for large lots of converted wood; it is especially suitable when only a few rich wood-merchants compete. It also serves as a remedy against coalition of buyers when trade is slack, and finally, in selling assortments for which there are no local purchasers, for instance, hop-poles, osiers, etc.

Whenever only a few large dealers are present at a sale, they can agree easily to keep down prices. By calling for sealed tenders the forest-owner may invite competition from distant purchasers in order to paralyse the coalition of local traders; this remedy may, however, prove to be of a temporary nature only.

(c) **Sale by Private Contract.**—The sale of wood by private contract is employed when the demand is slack. Often there may be only one or a few purchasers, it is then preferable not to auction the produce, but to deal directly with the purchasers; thus the best price possible will be obtained, which would not result from selling to the highest bidder when competition is so restricted. In this case also, the lots should be large, and the purchasers men of means. Sometimes the whole produce of devastated forest-areas are thus sold; sometimes an entire assortment—round billets, charcoal-wood for smelting-furnaces, large quantities of railway-sleepers, telegraph-posts, merchantable timber, etc.; sometimes large lots of converted wood, for which at an auction the bids were too far below the proper prices.

Sale by private contract recently has been extending in a remarkable manner, especially in North Germany, and desires for its further extension have been expressed. This may be justifiable for certain districts, but in most cases, and especially in sales of State forest produce, it should be considered rather as a necessary evil, enforced by a limited demand in slack times, than as an even tolerably regular mode of sale, for where trade is brisk, no forest-owner would wish, by private sales, to reduce the competition at auctions.*

SECTION III.—BUSINESS PRINCIPLES INVOLVED IN THE SALE OF WOOD.

1. *General Account.*

Owing to the moderate net-revenue resulting from forests, and the considerable amount of invested capital which they involve, it is evident that every forest-owner should strive, by improving the markets for his produce, to obtain as high a price as possible for it. The forest-owner may be unable to exert any influence on the general current prices of wood, and, as regards the sale of his own produce, may be fettered by the situation of his forest, the state of the local wood market and many other conditions; nevertheless the financial results of the sale of his wood, under the given conditions, depend greatly on his skill in managing sales. Much has been said already on this subject in the preceding sections; it is, however, necessary to discuss, in a general way, the principles and experience of mercantile business which are most nearly related to the above objects.

In order to sell wood profitably, a forester must be a trader, and must have the same aptitude for trade as other dealers who sell wares.

* [In Britain, coppice is sold generally at so much an acre, or the wood felled and sold in assortments after conversion. Standards over coppice are sold at fixed prices per cubic foot that increase with the girth of the tree; only the bole is cubed, and the crown given-in to cover cost of felling. In beech selection forests, the marked trees are felled usually by the owner, and the logs and faggots sold as they lie in the forests, and this is also the case with oak and Scots pines in the Crown forests, the price being fixed by private contract.—Tr.]

Forest officials entrusted with the sale of produce should have either mercantile experience, or endeavour to acquire it to a sufficient extent. Exactness in carrying out departmental orders and routine will not suffice here, for this is not by any means all that is needful for a commercial mental-outfit. Active and intelligent intercourse with the world, especially in all industrial and mercantile questions, observation of all causes which affect the market for his own produce, persistent endeavours to detect all precursors of trade, to weigh accurately the importance of all intervening occurrences and to form correct decisions after considering all these circumstances—only habits such as these make a successful trader.

2. *Genuine Goods, and full Weight and Measure.*

All solid mercantile success is founded on the genuineness of the goods offered for sale, and on giving the purchasers good weight and measure. Genuine goods are those that are equal to the description given of them by the seller. Every wood assortment should contain only pieces of wood, which are thus classified correctly. Every offer of inferior wood, every concealment of defects and damage in timber, every classification of pieces above their proper class, and so forth, impairs their genuineness. Wood should therefore be exposed for sale so that every would-be purchaser may ascertain its quality easily. In a similar way, full measure should be given in firewood stacks, and a thorough understanding arrived at as to the sale-measurements of logs, in order to maintain a good credit with purchasers.

A most careful assortment in accordance with prices inspires purchasers with confidence. With the same end in view, the price-tariff also should be compiled most carefully in accordance with the real value of the wood-assortments. Above all, timber should be classed carefully as regards its quality, and a forester should give no cause for a report that he sells half-rotten or inferior material as good timber. He should take great care not to mix inferior wood with good material, hoping thus to obtain a better sale for the former.

It is now about time to secure uniformity in all wood

measurements; especially should all timber be measured without its bark, and old country measures should give place to the metric system. **Only absolute correctness in measuring leads to genuine trade.** It frequently happens that in slack times for trade, logs are measured below their actual dimensions, or timber classified below its proper rating, with the object of finding ready purchasers at prices which appear to be on a par with, or even to exceed, the fixed tariff. Such manipulation must be abnegated entirely, for it impairs the confidence traders should feel in the honesty and accuracy of forest officials, hinders the compilation of a correct tariff, and serves only to blind superior officials.

3. *The Produce to be Sold.*

Every felling-area yields good as well as inferior wood. The forester should attend most carefully to the conversion and assortment of good material, for this affects greatly the financial returns of his forest; he should endeavour also as much as possible to avoid overstocking the market with inferior wood. This should be attended to especially when trade is slack, or the sale of good material will be prejudiced.

When the market is overstocked, it is better to leave stumpwood and inferior firewood in the forest than allow it to reduce the price of the better class of firewood; also, where poles from thinnings are in a similar condition, it is better not to classify them as timber. In slack times it is a matter of ordinary prudence to reduce to the utmost the cost of conversion of inferior material. Purchasers of such stuff will convert it more cheaply and more in accordance with their own wishes than forest officials.

In converting his trees, the forester always should be guided by the wishes of purchasers, as far as general rules will allow. Whenever, as is often the case, there is a generally expressed desire for any change in the details of the wood-assortments, the forester should be ready to meet the purchasers' wishes; they are usually the expression of the market requirements. When, for instance, there is a desire that stacked wood should be more than a yard long, or that butts should be longer than is usual

in the locality, the question should be considered carefully; it often happens that this is in consequence of a new demand for timber, and then in future the wood should be converted accordingly.

4. *Wood-Markets.*

A few decades ago, before the present world-wide means of communication had been established, each forest had its own local purchasers, its own more or less limited local market, to which practically each forest-range was confined. Only forests, which were favourably situated as regards water-carriage, were accessible to traders of the world-market to which most of the best timber was floated. Matters have changed in this respect, and at present almost every forest-range has a share in the world-market, and there are few forests too remote to feel its fluctuations. Although the local market has not lost its importance in certain forest districts entirely, yet, especially as regards timber, it is the world-market that regulates prices. Under these circumstances, the really enterprising forester must know not only his local market, but should also keep in view all the movements and changes of the world-market; although he may be connected with the latter only indirectly through the middleman, yet he should be acquainted thoroughly with the prices prevailing in the distant principal market, as well as with those of the local market.

The generally isolated residence of forest officials would be an insurmountable obstacle in the way of his obtaining this knowledge, were he not to avail himself of the assistance which is open to every trader. This consists in the public press and in consular reports from the chief timber-markets. As regards pamphlets dealing with the timber-trade, some are edited and distributed by the chief forest officials in certain States; others are private undertakings, for instance, *Das Handelsblatt für Walderzeugnisse*, the *Berlin Centralblatt für Holzindustrie*, *Austrian Forstzeitung*, *Revue des Eaux et Forêts*, *The London Timber Trades Journal*, *The Timber News*, the *American Lumberman*, etc.

Agents employed by forest-owners and State consulates would do great service if they would publish, not merely

periodic reports, but any rapid changes in the markets. The future only can decide as to the extent to which forest-owners, like other wholesale producers, can make use of regular travelling agents to offer their produce for sale, and arrange contracts and deal with purchasers, etc.

It hardly need be remarked that all endeavours which may be made to raise the price of wood should apply only to timber, for, with exception of a few country districts, it is impossible to rehabilitate firewood in competition with coal. As long, however, as firewood is procurable at a steady and moderate price, it will find always a ready sale. [In all large cities there is a great demand for kindling material to light coal fires. The price of such material in Devonshire is (1908) 50 lbs. for 1*d.*, 3 lbs. for 1*d.* in the Midlands, and 1 lb. for 1*d.* in London, so that there is still a field for the sale in Great Britain of this kind of firewood. In Ireland also where peat is the chief fuel, this cannot be dried in a wet summer, so that in the succeeding winter there is a good demand for firewood.—Tr.]

Although the fullest attention should be paid by the forester to the general market, he should endeavour to improve and extend his local market. Wherever industries using wood, such as sawmills, factories for wood-pulp, furniture, carved work, etc., exist, or are to be introduced and extended, they should be supported and assisted energetically, provided there is no silvicultural impediment.

5. *The Timber-Trade.*

Under present conditions, the assistance of the wood-merchant is, in most cases, indispensable to the forester. No wholesale producer can dispense with the middleman; least of all forestry, with its voluminous and heavy produce, its unequally distributed producing localities, and its owners, who are in general unfitted for trade (the State, municipalities, hospitals, etc.) As far as concerns the local market, and in cases where the latter favours a direct dealing between consumer and forest-owner, the wholesale timber-merchant does not intervene. The petty dealer is, however, a necessary and generally welcome member of the local market. Whenever

large quantities of wood, and especially of valuable timber, are in question, especially in forests with a small local demand, the wood, for the most part, would rot *in situ* if wholesale timber-merchants did not undertake its sale and distribution in distant districts, which are densely populated and poorly supplied with forests. Forest-owners and wholesale timber-merchants must therefore work hand-in-hand; good business relations between them are entirely in the interests of forests, as long as only through the latter the distribution and conversion of the raw material into marketable produce can be effected.

Under present trade conditions, so changed compared with the past, it would be a serious injury to a forest-owner were he to refuse to acknowledge the necessity of the middleman; on the contrary, he must endeavour constantly to improve his relations with him. For it is the timber-trader who endeavours to extend the present market and to open out fresh ones and improve the means of transport; who invests a large capital in buying timber and establishing sawmills; who follows with attention every change, however small, in the price of wood; who is constantly posted-up in all industrial changes in the conditions of transport or the incidence of taxes, and who is vigorously engaged in pushing on the timber business. All this energy of the timber-merchant, even though it is in his own interest, should be acknowledged thankfully by the forester. But if these desirable relations in the interests of both parties, between the forest-owner and the timber-merchant, are to bear useful fruit, the latter must also be more ready than is often the case to meet the former half-way.

6. *Modes of Sale.*

Public auction of converted wood should be considered as the regular, though not exclusive, mode of sale, for it is suitable only when free competition of purchasers may be expected. In slack times of trade and when markets are overstocked, and in the case of very large fellings, sale by sealed tender, by unit of produce or by private contract, may yield better financial results than auction sales under such conditions. Wherever, business being very slack, large quantities of wood must be

sold in remote and comparatively inaccessible districts, the forest-owner may have recourse to sale of standing trees by area. Whenever it is possible, however, auction-sale of converted wood is preferable.

After considering all local and temporary objections to any mode of sale, there can be hardly any difficulty in deciding which to adopt in any particular case. To act by routine in such a matter may cause great pecuniary loss, as experience has often shown. Especially in selling valuable timber, the forester should be guided not solely by custom, but should select, without prejudice, whichever mode of sale is best for the case in point.*

7. Season for Sales.

The season when trade is most active is clearly the best time to sell the produce. As a general rule, autumn, winter, and early spring are the best seasons for the sale of wood; matters vary locally in this respect, and the best seasons for sale depend on the necessities of the consumer, the dates of final payment for the wood, and the amount of leisure which the public interested in the purchase of wood can command at different seasons of the year; also, as regards merchantable timber, on the usual date when contracts to supply the timber are closed, and the season in which, according to local custom, wood prices are steadiest.

Demands for firewood are evidently greatest in winter, whilst building and industrial timbers are more in demand during the summer. As, however, nobody burns green wood, but allows it, in any case, to dry throughout the summer so as to ensure a profitable sale, it is better to sell the produce of summer-fellings in the autumn, and those of winter-fellings early in the spring. In years with prolonged cold winters, evidently the best time for selling firewood is in mid-winter, and then cart-transport is readily available. Small wood for agricultural purposes, which generally is brought into use

* [The Deputy Surveyor reports that in the Forest of Dean, trees are felled and sold in logs and butts as they lie. Any considerable quantity of timber is sold by sealed tender, and smaller or inferior lots by private contract, at so much a cubic foot for timber, varying with the girth, or in cords of 128 cubic feet.—Tr.]

immediately after felling ; railway-sleepers, which are sold by wholesale merchants and usually must be impregnated and delivered to the railway authorities by the beginning of summer. and other wood-assortments which are required early in the year, should be sold during autumn or early winter. When trees are sold standing, the sales should be effected in September, so that the merchants may know in time what business they have to undertake during the felling-season. If the technical requirements for certain woods prescribe that the felling should take place in the growing season, an enterprising forest-owner will endeavour to meet such a demand. The date of final payment for the wood sold is also more important than the immediate demand. Where sales are for cash down, they should be held in autumn and early winter, when the country people have most ready money ; if payment is by instalments, with security, the season for sale is less important, provided the interval before final payment, for which autumn is best, is not too short.

When the peasantry takes part in wood-sales, these should be fixed when they have leisure to attend, and that is usually during winter. As regards wholesale traders, they generally sell from timber-yards, where they keep their wood a longer or shorter time, so as to profit by favourable opportunities for sale. The petty dealer, on the other hand, buys only at favourable seasons, when he can dispose readily of his wood at a fair profit.

The above remarks may be summarised thus:—Autumn and winter, and the times nearest to them, are the most profitable seasons for selling wood ; by the middle of April, in ordinary years, the chief produce of felling-areas should have been sold. It should be noted also that people become accustomed to fixed dates for sales, conduct business accordingly, and attend such sales with the determination to purchase sufficient wood for their requirements.

[In India, the sales of standing trees and other produce from the State forests between the Jumna and Ganges rivers, are held annually in September, so that work in the forests may commence in November, as soon as the healthy, dry season has commenced.—Tr.]

Whenever large falls of timber result from storms, snow-break, or damage by insects, the sales should be hurried on and the wood cleared rapidly, even if only inferior prices are obtainable; for the loss by the threatened decay of the wood is, as a rule, greater than that due to a low price for it, whilst danger of further damage by insects is reduced.

8. *Extent of the Sales and Sale-Lots.*

The quantity of wood offered for sale should correspond with the number and position of the purchasers. In well-populated districts, with a fair consumption of wood and to satisfy local demands, under ordinary circumstances, a moderate supply of converted wood, say 600 to 1,200 cubic meters (400 to 800 loads) of timber and firewood usually sell better than larger or smaller quantities. In poorly populated districts with a small local demand for wood, and with large quantities of wood for sale and only a few wood-merchants competing, large wood sales are absolutely necessary. Whether in such cases the produce of several ranges, or of several felling-areas, should be sold together, depends on the expected amount of competition. In no case should valuable timber be sold at different times; it is better that neighbouring communes and even private forest-owners should unite to hold large sales, if their own fall of timber is small.

It is evident that most large timber-sales in which only large capitalists can compete, are chiefly sales of standing trees by area; for instance, in West Prussia, sales of 10,000 to 20,000 cubic meters (7,000 to 14,000 loads) of standing wood for three or five years are effected. Sales of 5,000 to 6,000 cubic meters (3,500 to 4,000 loads) of converted timber are not rare; as, for instance, in the forest-ranges of Jachenau, Walchensee, etc., of the Bavarian Alps, also in the case of the enormous masses of wood killed in S. Bavaria by the nun-caterpillar, for which sales of 400,000 and 500,000 cubic meters were held. It is not advisable to hold mixed sales of timber and firewood when chiefly wholesale merchants are competing.

Similar principles underlie the formation of sale-lots. The amount of competition and the class of traders present will decide their dimensions. The wishes of the public also should

be followed in this respect so far, that it may be possible for large dealers to purchase separately the assortments which their business requires. These consist chiefly of the better class of stem-timber. Where sales are held to satisfy local demands, only small lots are advisable.

Whilst in sales of standing trees, lots may consist of 500 to 1,000 and more cubic meters (350 to 700 loads); in large regular sales of converted wood the lots seldom surpass 30, 50, or at the most, 100 cubic meters (20, 35, or 70 loads); as a rule they are even smaller. It is otherwise in extraordinary falls of large numbers of trees, owing to storms, etc.; in such cases the size of the lots increases with the quantity of material to be disposed of, and with the capital of the competing merchants. In the sale of wind-fallen timber in the Vosges mountains, in 1892, besides smaller lots, large lots of 5,000 and 8,000 cubic meters were formed; and in the case of trees killed by the nun-caterpillars in Bavaria, the lots attained 10,000 cubic meters. Whether, in forming the lots, the same care should be taken as in forming the assortments of timber, *i.e.*, that the same lot should contain only the same quality of wood, depends on the numbers and kind of would-be purchasers present. [In the French State forests no lot of standing timber offered for sale should exceed 10,000 fr. (£400) in value.—Tr.]

9. *Conditions of Sale.*

It is self-evident that burdensome conditions, displeasing to the purchasers, will reduce competition, and that the sale will be the more profitable the less stringent are its conditions. On the other hand, the security of the owner against loss, and the demands of silviculture, must be ensured. It is difficult to say how far a forester can go in the latter direction without prejudice to the interest of the forest-owner; it depends on the state of the market and of prices, the solvability of the purchasers, the cost of transport, and the actual demands of silviculture. The less favourable the local and temporary conditions of the timber market, the less must one insist on conditions of sale which reduce competition; and this is more necessary when the purchasers are dealers than when the wood is disposed of among local purchasers.

One of the most important points is whether cash-payments should prevail, or credit be given. The question is regarded from different points of view in different countries. In most German State forests, except quite recently, cash-payment was the rule, but this has been modified considerably of late. Credit increases the work of accountants, often encourages swindling and indiscretion on the part of certain purchasers, but all this shady side of the credit system disappears compared with the disadvantage of reducing competition by demanding ready money. Credit is now-a-days such a necessary condition of all trade and business, that the forest-owner cannot avoid it. Sufficiently long credits, up to a half-year and even longer, in the case of trustworthy large dealers, are conditions which long experience, far from verifying the fears of extensive loss which have been expressed, has proved thoroughly justifiable in the interest of forest-owners.*

It is self-evident that credit can be given to doubtful purchasers only on sufficient security (after payment of 25 per cent. of the purchase money, deposition of valuable documents, promissory notes on good banking houses, etc.). In the different German States and in Austria, various systems of credit prevail, for instance, in Baden, 3 per cent. discount is given for cash payment, otherwise three to eight months' credit.

[In India, deposition of Government promissory notes, on which interest continues to be payable to the depositor, is the best form of security in wood-sales. It can be stipulated also that in sales of standing trees, one-third of the purchase money is payable after the wood is converted, and the balance on removal of the wood from the forest, more than sufficient wood being retained in the forest to cover the balance of the purchase-money.—Tr.]

The date fixed for removal of the wood from the forest or depot is also an important condition of the sale. If the limit allowed is too short, or not fixed with due reference to the cost of transport; if carts and beasts are few and are required

* The accountant's office at Aschaffenburg, which receives payment for the oakwood from the Spessart, had to receive between 1863—73, £111,400, of which only 27s. was a bad debt.

for the time being for agricultural purposes, the cost of transport will be increased, and the price of the wood consequently falls. In fixing the date for the removal of the wood, the forester should respect general departmental orders; in carrying them out he should be very lenient and consider the nature of the roads, that in some cases sand does not bind in winter, or other roads are too wet for use except during frost, or after dry summer weather; that in the case of water-carriage the logs cannot always be floated or rafted at a fixed time, and that country people prefer to work at wood-transport before the hay is mown, or after the corn has been harvested. If all the wood has been brought out of the forest, silvicultural rules will not intervene to hurry on the removal of the wood from the road-side.

10. *Advertising Sales.*

It has been remarked already, that competition at sales is improved greatly by judicious and timely advertisement. As no petty dealer is afraid of the expense involved in bringing his goods to the notice of consumers, and wholesale producers often spend immense sums in this way with good results; it cannot be doubted that in forestry, judiciously advertising timber-sales must have an important bearing on their financial results. Too great economy in this matter certainly will entail loss.

It should, however, be understood clearly, that no allusion is here intended to puffing advertisements, which are more calculated to excite mistrust than to stimulate purchasers. The advertising medium should be chosen much more carefully than is usually the case. Here is meant not only advertising in the public press, but also the despatch to large dealers, and other persons interested in the sales, of printed notices giving sufficient details of the sale-lots.

Wherever large numbers of logs are sold yearly and there is a more or less extensive demand for them, the timber-trade may reasonably expect to be informed by notices published beforehand, what woods and felling-areas will be taken in hand, and what will be their probable yield, so that timber-merchants may undertake contracts and make other prepara-

tions for the expected timber. In France and in many forest ranges of Prussia, Baden, Bavaria, etc., such notices are now issued regularly.

11. *Means of Transport.*

The great influence which the available means of transport has on wood-prices is well known, and has been already referred to. All unwise economy in providing good means of transport depresses prices, and improvement in this respect should be one of the first objects of the forest-owner.

Every intelligent forest-owner will endeavour to reduce the cost of transport from his forest. The forester therefore lays-out new roads, improves old ones, regulates floating-channels, constructs slides, sledge-roads or tramways; establishes depots on the banks of streams and canals and at railway-stations; he will see to the drying and seasoning of his wood, and in certain cases will convert his timber and split his firewood in the forest.

He should not be too narrow-minded in allowing the public use of the forest-roads. If a forest is to be lucrative, its roads should be always open, provided they communicate with the general network of public roads. The higher cost of repairs will be recovered fully by the improved means of transport.

Of immense importance, in this respect, is the proximity of railroads to the forests. Reduction of railway-rates for wood, and introduction of railways into the forests are vital interests to forest-owners, which they, in conjunction with the timber-trade, should use every possible means to secure.

[In Britain, this question is complicated by the fact that railway companies grant through rates for timber and other produce from their ports to the large inland towns, that are actually less than rates from intermediate places between the port and the place of destination of the timber. In this way foreign timber is favoured unduly.—Tr.]

For owners of extensive forests, provided that silvicultural requirements are not infringed, it is generally justifiable to entrust the transport of forest produce to contractors, as generally they can work more expeditiously and cheaply than large owners, and especially than the State.

12. *Forest Officials.*

If the manager of a forest is expected to work it to its full financial advantage, he must be allowed a free hand in timber-sales, so that he can act without delay in accordance with the demands of the market. Cases constantly arise when owing to an overstocked market the competition at auction-sales of converted timber is too slack, and other modes of sale must be tried.

Although control is necessary, especially in large State departments, yet it should not be too rigid, and a trustworthy executive official should not be fettered too much by routine but left sufficiently to his own responsibility, mere routine in timber-sales having disastrous results to the forest-owner. Now-a-days, thousands of pounds may be gained by taking time by the forelock, and using telegraphic communication between buyer and seller.

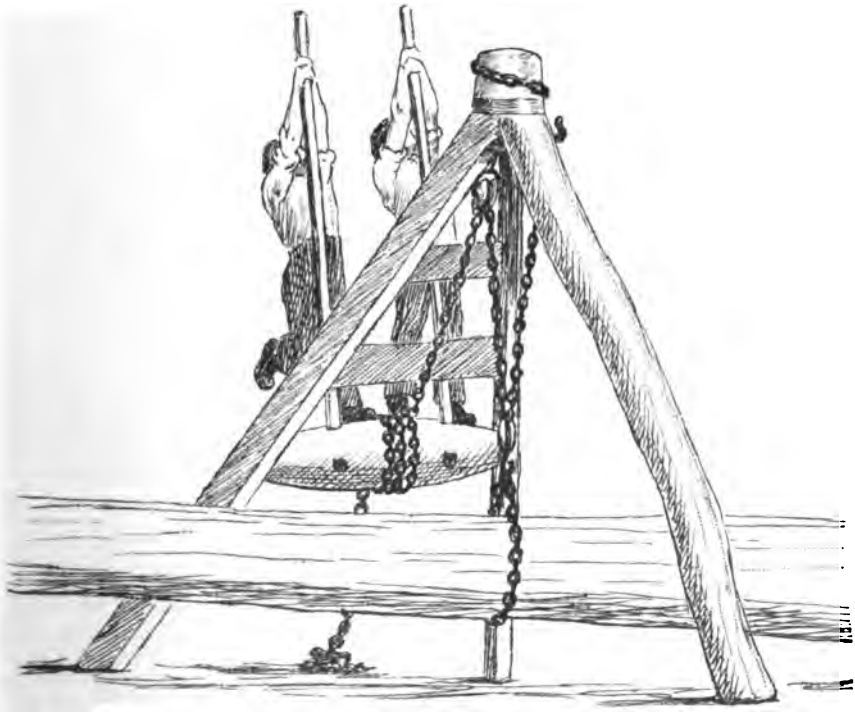

Fig. 295.—Derrick for raising logs on to carts. (*Vide* p. 313.)

Drawn by T. H. Monteath.

CHAPTER VIII.

AUXILIARY FOREST INDUSTRIES.

BESIDES the production of raw material from forests, there are several industries with the details of which a forester should be acquainted, as they either form part of his regular duties or are nearly related to them. They may therefore be termed **auxiliary forest industries**. They are based on the conversion by machinery of raw forest material into commercial products, partly by reducing it in size or altering its form, as by sawing, splitting, etc., partly by improving the natural quality of the wood and finally by completely altering its substance, in order to give commercial value to its constituents. The present chapter will therefore be divided into the following sections:—

- A. DETAILED CONVERSION OF WOOD.
- B. METHODS OF IMPROVING THE QUALITY OF WOOD.
- C. ALTERING THE SUBSTANCE OF WOOD IN ORDER TO OBTAIN ITS CONSTITUENTS.

A. DETAILED CONVERSION OF WOOD.*

In former times it was undoubtedly advantageous to the forest-owner to conduct some of these industries under his own direct control. Private enterprise has, however, gradually intervened, and most foresters now prefer to confine their exertions to the production of raw material, since owing to the increasing specialisation of industry and the difficulties of dealing with labour, it is an acknowledged maxim, at least as regards State ownership of forests, that the State should not compete unnecessarily with private enterprise. There

* The best work on this subject is by Braune, "Anlage, Einrichtung u. Betrieb der Sägewerke." Berlin, 1901.

are some foresters,* however, who consider it necessary or advantageous to direct auxiliary forest industries, especially when the profits made by the middleman in converting raw material into saleable wares is secured by the forest-owner, or when private enterprise fails to utilise the raw material to the best advantage; also in cases where it is necessary to lead private enterprise in the right direction, and thus, by producing goods of superior quality, obtain a better market for them. In the same way agriculture is not restricted any more than forestry to the production of raw material, but undertakes many industries that are properly of an auxiliary nature.

Since, therefore, several auxiliary forest industries are often conducted directly by the forest-owner, or by the State, the most important of these will be now described in a general manner.

SECTION I. SAWMILLS.†

The transportability of the wood produced by a forest influences the revenue of the latter considerably. Timber in the round cannot, as a rule, bear transport to a distance and timber-prices would in general be very low, were it not possible to convert heavy logs into planks and scantling and thus facilitate their transport to a distance from the forest. This conversion is effected chiefly by sawmills situated either in or near the forest, the existence of which enables many forests to be worked at a profit and affords a market for their timber.‡

The question whether sawmills should be managed by forest-owners, or left to independent private industry, has, in the

* [This is especially the case in the Sihlwald, a forest belonging to the town of Zurich, where the wood is worked up in detail into all kinds of mercantile produce, besides being treated on the spot with antiseptic substances.—Tr.]

† "Sawmills," by M. B. Bale, London, Crosby Lockwood & Co., 1898.

‡ [It is stated that sawmills were run by water-power in Germany as early as 1322. An attempt to establish a mill in England in 1663 was abandoned owing to the opposition of the sawyers, and one erected at Limehouse, in 1768, was destroyed by a mob. North America is the home of sawmills, one having been erected in Maine in 1634. "Encyc. Brit.," 1886, "Sawmills," by Hotchkiss.—Tr.]

German State forests, with few exceptions, been decided in favour of the latter alternative. The State should not, however, hesitate to favour and support sawmills, as its interest lies clearly in that direction. As, moreover, sawmills are controlled sometimes by forest-owners, especially private owners of large forests, and it is desirable that foresters should possess some knowledge of their mode of construction and management, a general account of them is included in this book.

(a) **Forest Sawmills.**

1. *Description.*

The ordinary forest sawmill is characterised by its position in a forest, its usually simple mode of construction, by being driven by water-power and having as a rule only one blade to a saw. It consists of three parts, the frame which moves up and down with the saw, the travelling or butt carriage supporting the logs, which are to be sawn, and mechanism for setting both the above in motion.

The saw-blade *a* (Figs. 296, 297), is nearly vertical and fixed in the frame *bb*, moving up and down with it between the wooden slides *ee*; below the frame is a pitman *f*, which is attached to a crank *g*. Every revolution of the wheel *B* drives the saw up-and-down by means of *g*. The cut is effected by the downward stroke of the saw, the steep edges of the teeth being pointed downwards. During the upward stroke, the butt to be cut must be pushed forward against the saw. With this object, the butt is placed on the carriage *h*, which consists of a long, somewhat narrow, strong platform. The head-blocks *P* and *P'* are dovetailed into the carriage at each of its extremities and serve to hold the butt in position. The carriage is pushed forward by means of a rack *n*, which is driven by the pinion *k* of the cog-wheel *L* and the latter by the cog-wheel *M*, on the axle of which another cog-wheel *N* is fixed and driven by the ratchet *q*; *q* is connected by a hinge with one of the levers *rr* attached to a cylinder *y*, which is moved through part of a rotation, and back again, by the motion of the other lever *r* attached to the upper part *b* of the saw-frame.

Thus every upward movement of the saw-frame forces *g* against the wheel *N*, which is thus set slightly in motion and

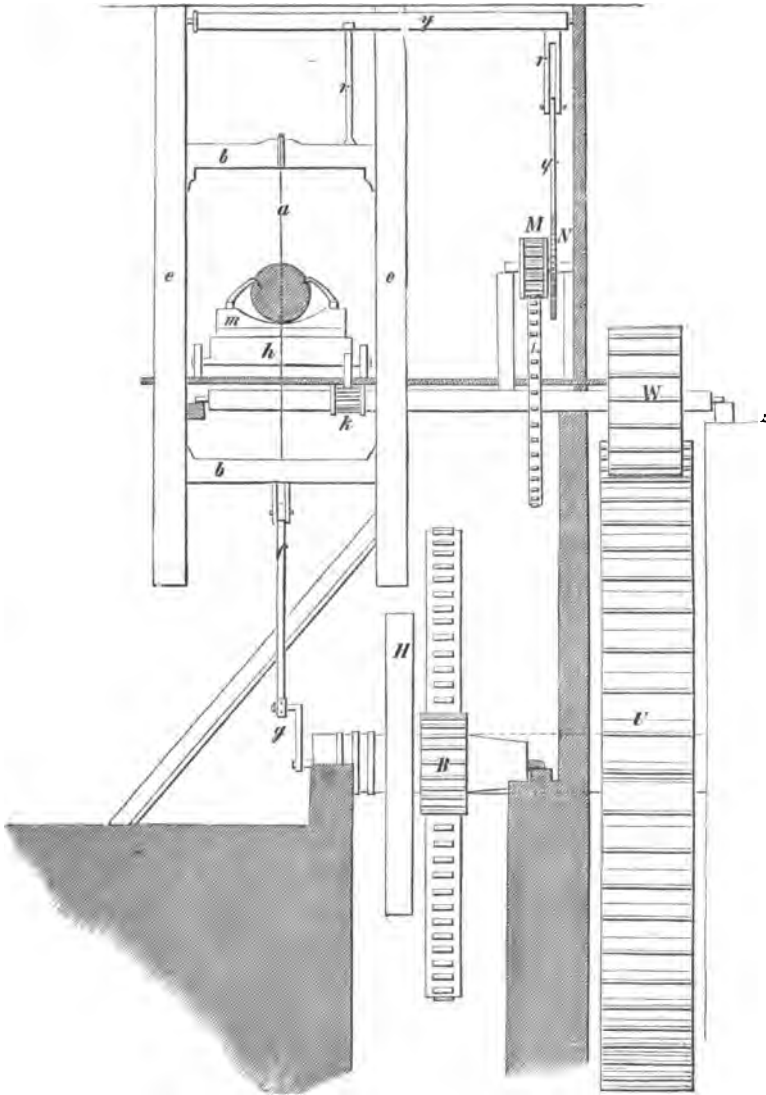

Fig. 296.—Forest sawmill driven by water-power.

communicates the motion through the cog-wheels *M*, *L*, *k*, and pushes forward the butt-carriage and the butt against the

saw. At the downward motion of the saw-frame, the ratchet *q* is drawn backwards, catching a cog in *N* when the saw is at its greatest height and again forcing *N* round at the

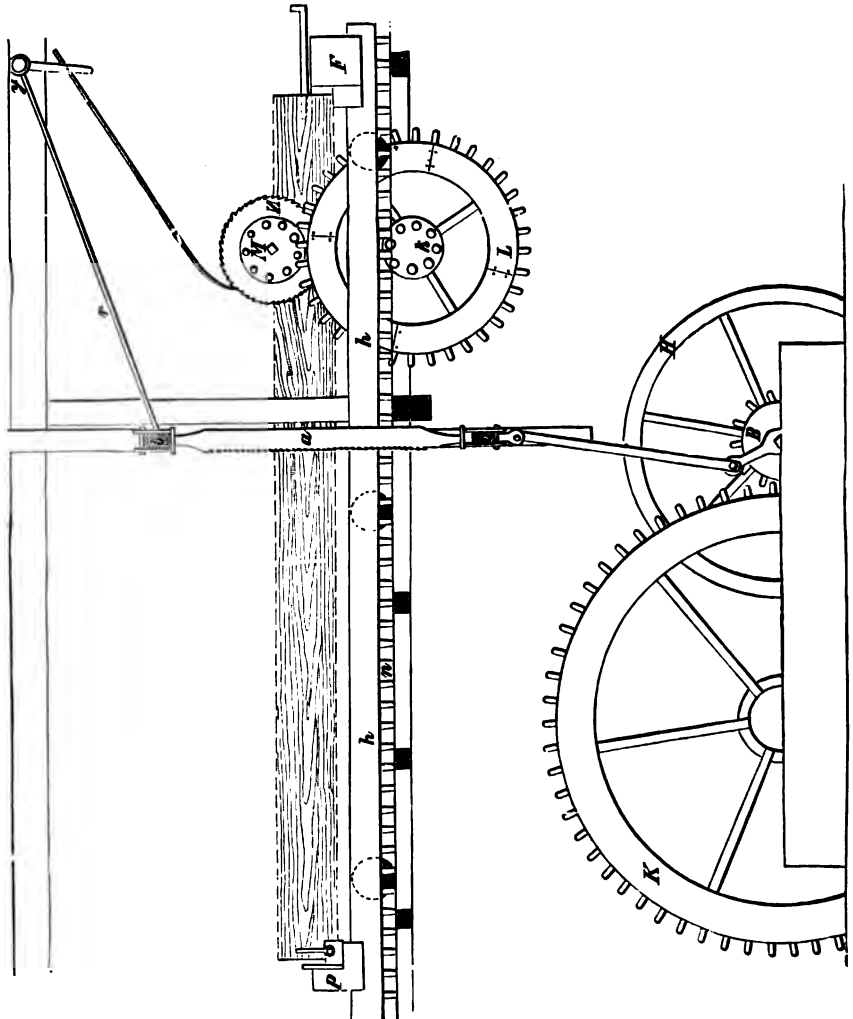

Fig. 297.—Forest sawmill driven by water-power.

next down stroke of the saw. *U* is the water-wheel which drives the saw, the small water-wheel *W* being used to drive back the butt-carriage when the butt has been sawn through.

H is an iron fly-wheel which regulates the motion of the machinery.

As soon as the butt has been sawn through its entire length, the butt-carriage is pushed back as far as it will go, and the butt adjusted for a second cut and so on, till it has been completely sawn into planks.

Recently, many forest sawmills have been improved* in various ways; some of them, however, are still sadly wanting in this respect. The improvements are directed mainly to improving the outturn of sawmills, both in quantity and quality. The most important of these are the material of which the machinery is constructed; the mode of suspending the saw-blade; its form and the nature of the teeth (their thickness, shape and set); the movement of the carriage and the mode of fastening the butt on to it; the rapidity of the saw, etc. Besides these points there are several others, so that evidently there are at present many different kinds of sawmills.

An efficient sawmill should utilise all the available water-power, should yield a sufficiently large outturn of planks, the latter being clean-cut; there should also be little waste of wood and economical working should be ensured.

2. *Material Used.*

If all the parts of a sawmill are constructed of wood, they must be very massive and hence require considerable motive power; much friction is thus caused. The more, therefore, iron is used instead of wood, the less these inconveniences are felt; on this account, the saw-frame and the guides between which it slides as well as the wheels and driving mechanism are made of iron in all new sawmills.

3. *Mode of Suspension of the Saw.*

As a rule, there is considerable resistance offered to the down passage of the saw-blade by the butt. If the saw is

* See W. Kankelwitz, "Der Betrieb der Sägemühlen," Berlin bei Gürtner, 1862; J. D. Dominikus, "Das illustrierte Handbuch für Sägemüller und Handsäger," Remscheid-Vieringhausen, 1889-90, 2nd ed., 1891.

suspended vertically, the first tooth of the saw which strikes the butt would do all the work in sawing, the other teeth passing uselessly through the cut made by it. In order then to divide the work equally among the teeth and afford room for the butt to come forward during the up-stroke of the saw, the crank gives a forward motion to the blade in its downward cutting stroke and a retreating motion as it rises from the cut. The distance by which the topmost overhangs the lowest tooth is termed the *slope* of the saw. On this depends the cleanness of the cut.

4. *Kind of Teeth Used.*

The most usual mode of construction of the teeth is that shown in Fig. 298, the cutting side of the teeth being somewhat out of the horizontal line. Fig. 299 shows the old



Fig. 298.—Usual form of teeth.



Fig. 299.—Old form of teeth.

German pattern of teeth which is still sometimes employed. The area of the teeth is usually in a ratio 1 : 2 to that of the spaces between them, but in the case of saws used throughout the year for sawing coniferous wood, this ratio may be as low as 1 : 3.

5. *Thickness of Blade.*

It is highly important for saws to have a proper thickness of blade. Too thick a blade wastes much wood and motive power, for the latter must be greater the more sawdust is produced and the broader the cut. When, however, a stronger motive power is used the tension of the blade must be greater, this involves a heavier frame and increased strength in all the other parts of the mill. All this causes increased resistance and friction. Too thin a blade, on the contrary, is not sufficiently stiff, easily gets heated, its tension becomes slack and it then cuts in a wavy manner; it may also fail to cut through hard knots or annual zones in the wood.

Saws for hardwoods and for resinous, knotty wood of many conifers should be thicker than those used for soft, clean-grained coniferous wood free from knots. For blades of moderate length $1\frac{1}{2}$ to $2\frac{1}{2}$ mm. may be considered the best thickness for saws. Saw-blades are made now even thinner than this, while formerly blades $5\frac{1}{2}$ to 7 mm. thick were used. Thin blades give a cleaner cut than thick ones. A good blade should also thin off towards its back. From average annual results recorded in the Harz mountains, it appears that with old thick saw-blades the saw-dust amounted to 10 or 11 per cent. of the whole butt sawn, whilst with thin blades it is only $2\frac{1}{2}$ per cent. There are, however, in the large coniferous forests, where the price of wood is low, many sawmills where the loss of wood still exceeds 12 per cent.

6. *Set of the Saw.*

The extent of the set of the saws also influences the loss of wood considerably. Setting facilitates sawing, but only at the expense of the outturn, both in quantity and quality. Old-fashioned saws working in wood of good quality usually have a set of 0.75 to 1.00 of the thickness of the blade, causing the kerf to be often 7 mm. and more. Attempts have recently been made either to dispense altogether with the set or reduce it as much as possible.

7. *Length of Blade.*

The length of the saw depends on the thickness of the butts and on the play of the saw (*i.e.*, double the length of the crank *g*, Fig. 296). The shorter the blade the greater its possible tension and the cleaner it cuts. The shortest length possible is double the thickness of the largest butt which is to be sawn. In a good sawmill this minimum should be exceeded only slightly; evidently the play of the saw must correspond with this.

8. *Mode of Fixing Butts on the Carriage.*

The butt must be fixed firmly to the carriage, so that it remains rigid while being sawn. Numerous contrivances have been invented with this object in view.

9. *Rate of Motion of the Carriage.*

The rate at which the butt-carriage moves towards the saw must correspond with the rate of the saw and the depth of the cut. The butt must not be too forward for the action of the teeth; in order, therefore, not to overtask the teeth, the butt must advance less than the slope of the saw and size of the teeth apparently permit. In most old sawmills the depth of the cut is between 6 and 12 mm.; in new ones between 80 and 96 mm. Instead of the old arrangement of the rack and pinion feed, rollers are used, by means of which the workman has a far better control over the rate of progression of the carriage.

10. *Rate of Sawing.*

The rate of sawing depends on—the relation of the amount of motive power available to the mechanism in use; the degree of resistance offered by the wood and of friction by the saw during the sawing; also the amount of play of the saw, for the greater this is for a given motive power the less rapid is the rate of sawing. In old saws the play of the saw was often 0.60 to 0.80 meters, with a moderate water-power and moderately-sized butts 70 to 120 strokes were given in a minute. When a return was made to short blades and the play was reduced there was an increase in the number of strokes per minute. Superior saws of new construction have a play of 0.30 to 0.50 m., and give on the average 200 strokes in a minute. It should be noted also, that the more rapid the sawing the greater the space left between the teeth of the saw.

11. *Economical Working.*

The value of a sawmill depends also on economical construction and labour. It is evident that simple forest sawmills driven by water-power, in which only a small capital is invested and where owing to their situation in the forest transport-charges are minimised, can work cheaply and compete with large sawmills which have more difficulty in securing cheap raw material. As regards the quality of the planking, however, which depends on the best mechanism, as a rule,

the large mills are superior, owing to their smooth cut. [The maintenance of State sawmills in French coniferous forests depends on the wish of the Government to enable small timber purchasers to compete with large sawmill owners, who would otherwise have a monopoly. The State gives the use of a conveniently situated sawmill as one of the conditions in the sale of a lot of trees. The purchaser pays to the State a fixed rate per square meter of wood sawn.—Tr.]

(b) **Steam Sawmills.***

1. *Frame-saws.*

Although most of the sawmills which will be now described are driven by steam, the use of water-power is not excluded; it must then be strong and steady so as to be suitable for powerful turbines. Whilst forest sawmills usually work with only one saw, or at most two saws, steam sawmills are supplied with a number of saws and other wood-working machines, so that they can turn out wood completely ready for use in buildings, etc. They differ chiefly from forest sawmills by their enormous outturn and its better quality.

Besides differing from forest sawmills in these points and in their motive power, steam sawmills also are constructed differently; being formed completely of iron they are more compact, stronger, possess greater stability and work more evenly; friction is reduced to a minimum and they are much more powerful. This greater power is utilised specially in steam sawmills by there being several saws, up to 10, in the same frame, all of which work at once; a butt is thus sawn into planks in one operation. These are termed **multiple saws**. As regards the power required to drive multiple saws, it is estimated that three horse-power is required for the empty frame alone, one horse-power for the first four blades and for every other blade half a horse-power. These saws are constructed on the same principle as ordinary saws, but mechanical

* An excellent account is given of modern American sawmills by Hotchkiss in "Encyc. Brit.," 1886, vol. xxi. Also see Worssam & Co.'s catalogue (King's Road, Chelsea). Mathey, "Exploitation Commerciale des Bois," vol. ii., 1906, gives an excellent detailed account of steam and water sawmills.

improvements are introduced to increase their efficiency and reduce the motive power required to drive them.

Figs. 300 and 301 represent one of the numerous kinds of

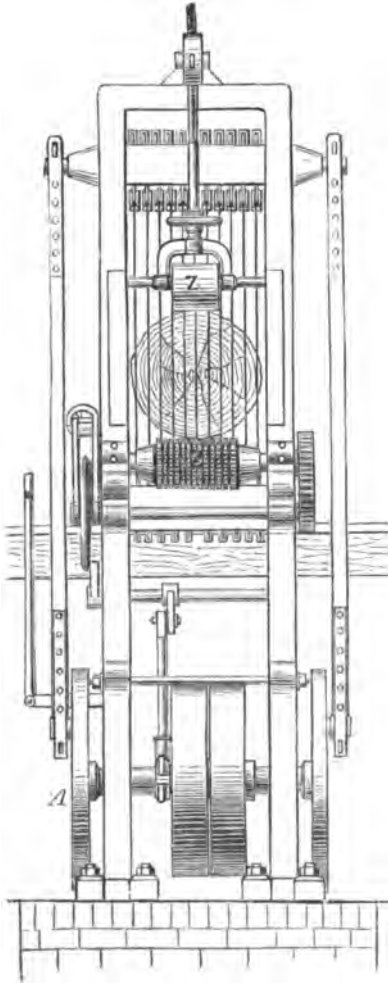

Fig. 300.—Multiple saw.

multiple saws from the catalogue of Kircher & Co., of Leipzig. The frame, which is generally driven from below (*A*), runs very smoothly in simple bearings (*a a*) and may support 10 to 20 blades at suitable distances. The blades are usually fixed in the frame by wedges. The butt to be sawn is supported on carriages (*m m*), one on either side of the saw and both running on a light tramway, on which it is firmly secured by iron dogs (*n n*). Two pairs of removable grooved iron rollers (*z z*) above and below the butt press it forwards against the saw. As soon as the butt has been sawn through it is removed by butt-carriages in front of the saw, another butt is then brought up from behind into contact with the saw. No time is lost, as in forest sawmills, in reversing the butt-carriage while butts and logs of any

length may be sawn. Fig. 301 shows the same saw in perspective.

In order to save time in sharpening the saws (which must generally be done every 6 or 7 hours) the frame with the saws

in it can be removed easily and another with freshly-sharpened saws substituted.

The best steam saws have a play of 30 to 50 centimeters

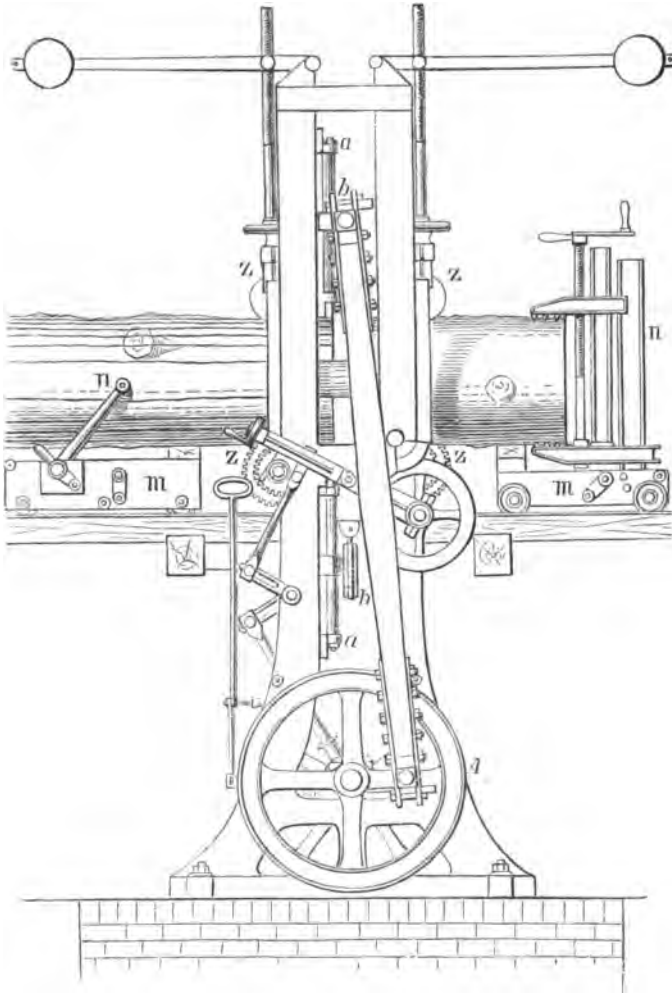

Fig. 301.—Multiple saw.

(12 to 20 inches), giving 200 to 300 cuts a minute. For sawing coniferous woods they have very thin blades with scarcely any set; they turn out planking, whenever a large quantity of raw material is available, at rates scarcely dearer

than ordinary forest saws. It should be noted also that saw-mill engines are often driven by burning sawdust and refuse

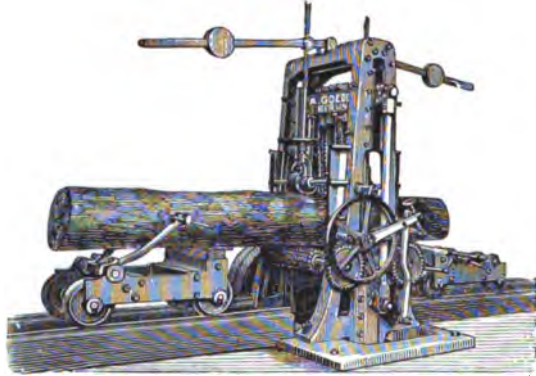

Fig. 302.—Transportable sawmill.

wood instead of coal, this being rendered possible by the use of special furnaces.

Besides fixed sawmills, transportable frame-saws, termed in America pony-saws, are now employed. Fig. 303 shows their mode of construction: they are on wheels and are driven by a belt from a locomobile; they are valuable in forestry from the

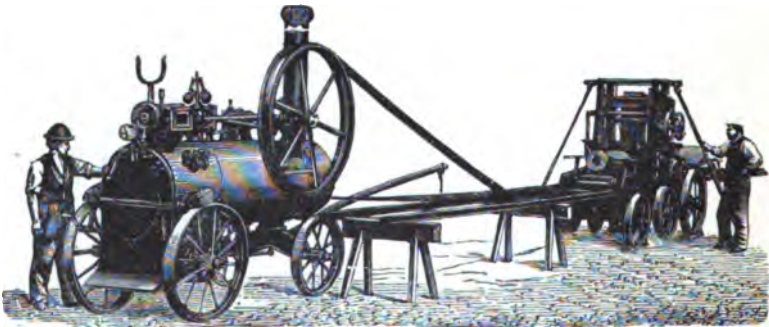

Fig. 303.—Transportable sawmill.

fact that it is more natural to transport saws to the forest, than wood in bulk from the forest to the sawmills.

California is at present ahead of all other countries in saw-mills, not only in constructive ingenuity, but also in the use of

mechanism to replace manual labour in working the mills. As the question there is one of entirely clearing the forests of wood, for which purpose tramways are constructed expressly and penetrate every year deeper into the forests, it is evidently business-like to set up pony-saws in the midst of the forest; nowhere therefore are various kinds of pony-saws more the order of the day than in California. They work generally with circular saws.

2. *Circular Saws.*

Circular saws consist of a circular thin steel blade furnished at its rim with a continuous row of teeth and capable of rapid rotation round a horizontal axis. These saws are vertical, and only about $\frac{2}{3}$ of their area is available for work.

Circular saws require a comparatively low motive power; their dimensions vary considerably from 8 in. to 4 feet (0·20 to 1·20 m.) diameter, whilst the thickness of the blade varies from 1 to 3·5 mm. A moderate-sized circular saw moves, at its circumference, at the rate of 50 to 65 feet (15 to 20 m.) a second, for hardwood and 65 to 100 feet (15 to 30 mm.) for softwood.

The commonest uses of circular saws are as follows:—

i. Large circular saws for removing side-pieces from beams, thus replacing much tedious work with the adze. Although this can be done also by frame-saws, yet the circular saw is often preferred, as it works the more quickly of the two. By means of mechanism, the log resting on rollers moves automatically towards the saw.

ii. Large saws for cutting butts into planking; these are generally used after the butts have been sawn in half by frame-saws. Circular saws are used much more commonly for this purpose in America than in Europe.

[Where driven by engines of from 25 to 100 horse-power, the circular sawmill will turn out 20,000 to 60,000 feet a day in addition to running double-edge and trimming saws, trimming off the rough edges and bad ends of the lumber.*—Tr.]

iii. Double-edging circular saws for edging planks and boards consist of two saws on the same axis, the distance between them being capable of adjustment. They feed by rollers.

* "Encyc. Brit.," 1886, vol. xxi., p. 345.

iv. Saws for laths resemble the above, but there are 3 to 5 blades on the same axis, which cut up planks into laths or other scantling.

v. Ordinary circular saws, used for sawing planks into thin boards, such as those used for cigar-boxes, packing-cases, staves, etc. The wood may either be pushed by hand along a bench to the saw, or automatic feed may be adopted.

vi. Another form of circular saw is used for shortening logs, removing bad ends of planks, refuse wood, etc. These saws may be either fixed or transportable.*

3. *Band-Saws.*

A band-saw is a long thin flexible steel ribbon uniting to form a belt and bearing teeth on one side. It passes above and below over two large pulleys, the lower pulley driving the saw, while the upper one is driven by it. Thus, like the circular saw, the band-saw cuts continuously, and also either vertically or horizontally.

Band-saws require 25 to 40 % less motive power than circular saws, the friction caused is also less and very little waste of wood is caused, saving 20 % compared with other saws. They yield smooth and fine scantling.

Band-saws were first used in small work, either with a fixed or movable table, and especially for cutting along curved lines. More recently they have been used for sawing large butts (Fig. 304) and are now ousting frame-saws for this and other purposes, especially in America, where the band-saw is considered the saw of the future and can turn out 40,000 feet in a day.

Machine-saws for felling trees have been described already (p. 181).

4. *Saws for cutting Veneer and thin Boards.*

Veneer-saws differ from other frame-saws by working horizontally with their teeth pointed downwards. The wood to be sawn is fixed in a vertical frame, the feed being of an ordinary nature, except that it is from below upwards.

* For a good description of an American sawmill, *vide* "Encyc. Brit.," vol. xxi.

Veneers are sawn from planks of valuable wood, that are frequently glued to ordinary coniferous planks and then placed in the frame. The valuable wood can be sawn entirely

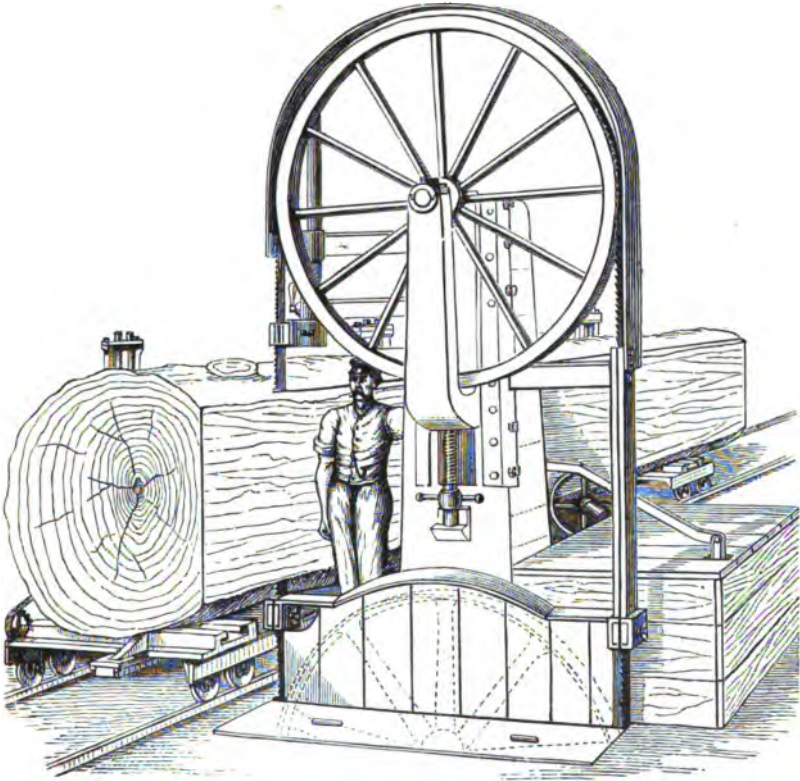

Fig. 304.—Band-saw.

into veneer without any waste, the thinnest veneers sawn being 7 to a centimeter. Drum-saws have been invented recently for sawing curved staves for barrels.

5. Outturn and Assortment of Sawn Material.

The outturn from sawmills and the sorting of the material can be discussed here only in a very general way, so far as it concerns foresters.

[It is best to begin by defining the different kinds of boards according to the English market :

| | | | | |
|--------|----------|-------|-----|---------------------|
| Boards | 7 inches | broad | are | battens |
| „ | 9 | „ | „ | deals |
| „ | 11 | „ | „ | planks.—Tr.] |

When the logs are sawn into boards, there is a wastage of 30 to 50 % in wood free from sapwood, so that one hundred cubic feet of sawn material comes from 166 cubic feet of timber in the round, or 100 cubic feet of round timber yields 60 cubic feet of planking ; in planks of the best quality, the outturn is only 30 to 40 %. The wastage is least in beams and large squared pieces, more for planks and most of all for battens free from sapwood and pith.

In assorting sawn timber the most important points are : **soundness, dimensions, knottiness, coarseness and fineness** of sawing, **squareness** of section ; whether the boards are of the same breadth at either end or are slightly conical, also whether the **bole** or the **top** of the tree has been sawn. Besides these, the nature of the timber, quality of grain, straight or torse fibre, colour and finish must be considered. The parts of the bole between the pith and sapwood yield the best boards, while the central board is the worst, and contains usually a number of small hard knots. Of knots, loose ones reduce quality greatly, while sound firm knots are less injurious. The length of boards depends on local custom, but their value increases always with their breadth.

As regards the storing of boards from freshly-felled stems they should be left lying one on another for a short time after the sawing in order to prevent warping ; then they should be stacked vertically for a few days against a horizontal bar with supports. This allows much sap to run out. They should then be placed in rectangular stacks, raised from the ground on supports, each board being separated from its neighbours by a small piece of wood, so as to allow complete aeration. Oak planks should not be placed one on the other as they were in the log, but on their edges and apart. Only after a few months should they be stacked, as they were in the log, with pieces of wood between adjoining planks. In large stacks a

slight inclination to the horizontal should be given, so as to allow the rainwater to drain off.

SECTION II. OTHER WOOD-WORKING MACHINES.

1. *Veneer-planes.*

For a number of years veneer planes have been used instead of saws for cutting veneer. There are two kinds of machines used, one cutting straight and the other spirally. In the former, either the horizontal 6-foot blade is fixed and the wood pushed under it, or the wood is fixed and the blade works over it, the veneer coming off of the thickness of paper. With spiral machines, the wood is in cylinders and is fixed in a lathe and turned slowly on its axis. The sharp blade acts tangentially on the wood and keeps cutting in deeper, until the veneer is pulled off in one long piece from the cylinder that is reduced gradually in size. The thickness of the veneer can easily be as low as 0.25 mm., so that there are 40 widths in a centimeter of wood.

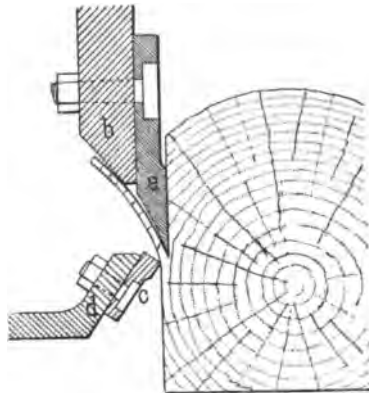

Fig. 305.—Plessis' machine.

[A machine for cutting thin boards was invented in 1875 by Léon Plessis,* the action of which may be understood from Fig. 305; (a) is the cutting blade, 3 or 4 meters long, fastened to a frame (b); (c) regulates the thickness of the cut pieces of wood, which may vary from 2 to 20 mm. The greatest thickness which can be cut is 2 centimeters, supplying boards for cigar-boxes, packing-cases, etc. The instrument slides up and down in a vertical frame, a piece of wood being cut at each down stroke, and the butt, which is being cut,

* Société Française de tranchage de bois, 4, Passage Charles Dallery, Paris.

advances through a space equal to the thickness of the section at each up-stroke. The cutting part of the machine weighs 6 tons. The butts cut are as long as the cutting-blade, and are steamed previously, the wood being chiefly softwoods, such as poplar or alder. This process yields 30 or 40 sheets to the inch, while sawing veneers yields only about 12 sheets.

The pieces when cut are pressed dry by hot rollers; then they are replaced consecutively so as to reproduce the form of the butt from which they were cut, when they are fastened together and kept ready for use.

This machine is driven by 20 horse-power and cuts in a minute 20 pieces, 3 meters long and of any thickness up to 2 c. It can cut 30,000 square feet of boards in a day.*—Tr.]

2. *Planing-Machines.*

Planing-machines consist of rapidly rotating, narrow, steel cylinders up to a meter in length on which several removable blades of the same length as the cylinder are fixed and they plane the pieces of wood that are pushed forward under the cylinder. Planes of this kind are now constructed, either to plane smoothly, or to cut mouldings in the wood. There are also planing-machines that plane four sides of a piece of wood at once. In this way wood is prepared for door and window frames, for parquets, for picture-frames, etc., and such pieces are sent extensively into the market by forest-owners in Sweden.

3. *Wood-turning Machines.*

Wood-turning machines of various patterns are used to cut curves in wood, as in the legs of chairs, etc. The cutter takes the form of a spindle with spiral or angular blades.

4. *Wood-wool Machines.*

These are planing-machines in which the plane is fixed and the piece of coniferous, poplar or limewood is pushed against it, or the plane moves over the wood that is fixed. The cutting edge is movable and of various dimensions, so that pieces of wood can be cut of different sizes.

* Boppe, *op. cit.*

5. *Wooden Thread Machines.*

These are constructed similarly to the above-mentioned machines, only there are a number of circular planes fixed close together on a flat edge. Either the wood is pressed against the planes or the latter against the wood; round rods or threads are produced of the same diameter as the planes, and of the same length as the piece of wood.

6. *Wood-bending Machines.*

As already stated (p. 96) wood becomes pliable when moistened and heated. Steamed or boiled wood when dried retains the shape that is given to it. Manual labour suffices to bend small pieces of wood, but large pieces for wheel-felloes or for curved wood used in ships and barges are bent by machines. As in bending wood the fibres on the outer convex side are stretched and may break, precaution is taken to bend the wood rather by shortening the inner fibres than by stretching the outer ones. The piece of wood is therefore fixed along a thin piece of steel between two strong bent iron clamps at its transverse ends. The wood is then pressed against a cylindrical surface, so that both wood and steel are bent, the steel preventing the stretching and breaking of the wood-fibres.

7. *Wood-pressing Machines.*

Cast brazen dies are pressed into wood by a strong iron press. The wood is boiled or steamed, or the dies are heated by red-hot irons. Wood can be pressed more easily on its transverse section, than tangentially or radially. A piece of veneer is glued on to the surface of the wood before it is pressed, so that it may be imagined that the wood is curved and not pressed. If pieces of veneer 3 mm. thick are pressed between two slightly undulating iron plates, the undulations in which fit into one another, wavy wood, or curls, may be imitated. When this wood is planed, imitations of mottled wood are produced completely resembling the structure shown in Fig. 47.

8. *Wood-pulping Machines.*

There are two kinds of these machines, one in which the surface of the wood is rubbed or planed away, and this is

done usually by manual labour. In the other kind of machine the wood is cut up into wood-pulp for paper manufacture. By the former method the wood in cylinders 10 to 25 cm. in diameter and varying in length, of aspen, lime or spruce, is barked and cut into pieces about a foot long; it is then split and all knots bored out of it. Then the pieces are pressed against a rotating stone under a steady flow of water, the coarser fragments are sifted off and separately reduced to pulp, and the fine pulp freed from superfluous water and pressed into its marketable shape. This is **white pulp** of the same colour as the wood.

If, before grinding, the wood is steamed at a pressure of 2 to 6 atmospheres or boiled, **brown pulp** is produced, which has longer fibres than **white pulp**; after adding glue, clay, etc., it is used for brown paper for packing purposes. The first wood-pulping machines were constructed in Heidenheim by Völter; they require a considerable flow of water, both for power and for the purposes of manufacture. There are now 700 pulp-factories in Germany, which use annually one million solid cubic meters of wood (35,000,000 cubic feet).

Besides the more important wood-working machines there are a number of others used for special purposes, such as mortising and turning machines, and oscillating augers for boring holes of various dimensions. Among the splitting machines those for reducing the size of firewood billets are employed extensively in large towns.

B. TREATMENT FOR THE IMPROVEMENT OF WOOD.*

SECTION I. IMPROVEMENT IN APPEARANCE AND QUALITY.

1. *Improvement in Texture.*

The woods of many species, *e.g.*, lime, birch, alder and conifers, are not ornamental, but the method described on p. 501 can be adopted to render them so.

* R. Stübbling, "Technischer Ratgeber auf dem Gebiete der Holzindustrie." Leipzig, 1901.

The texture of valuable woods is imitated by stamping on soft woods the characteristic marks of good woods, by means of hot cylinders or plates on which these marks are embossed. They cut grooves in the wood resembling sections of wood-vessels, so that alder or beech wood may imitate *Cedrela odorata* for cigar-box wood. The texture also may be imitated by **graining**, in which a ground-work of oil colour is made, first, by laying on two coats of a colour lighter than that of the wood to be imitated, and then, with a kind of comb, or a fine paint brush, the veins, etc., are painted with turpentine coloured to match them. Thus walnut is imitated from alder and beech, mahogany from cherry-wood, rosewood from sycamore, oakwood from spruce, pine or silver-fir. A finer texture is obtained by branding.

The best means of improving the texture of wood is by the use of veneer, when softwood is covered by thin sheets of a valuable wood. This cannot be called a falsification, for veneering involves cheapness, reduction in weight, and prevents warping. The woods of spruce, pines, silver-fir, limes, and poplars are used as the substratum (*Blindholz*), whilst finely textured and coloured walnut, mahogany, rosewood, bird's-eye maple, ash curls or oak serve as veneer. By special arrangement of the markings on the veneer, symmetrical figures are produced that heighten greatly the beauty of the work. The adjoining surfaces of the blind-wood and veneer are roughened carefully with a special plane and the former covered with glue on which the veneer is pressed. This plane has a row of pointed teeth, instead of a flat cutting edge.

2. Improvement in Colour.

There are numerous materials for improving the colour of wood. Thus **bleaching** is effected by destroying the colouring-matter in wood by various chemicals that are rich in oxygen, such as hydrogen peroxide and ammonia, sodium or barium peroxides with oxalic acid, or silicates of alkalis; also with calcium-chloride and solutions of soda or potash. **Staining** is done to give a fashionable colour to inferior wood, either by imitating the colours of exotic woods, or even

colours that do not occur naturally. If the wood is to be coloured superficially only, it is sufficient to paint it with the stain. If it is to be stained throughout, as is necessary for wood-mosaics, apparatus are used similar to those impregnating wood with antiseptics. Staining does not obliterate the texture of the wood.

Brown stains are used for imitating oak and walnut wood, or to give these woods the appearance of antiquity. Beech, birch, hornbeam, spruce and silver-fir take brown colours well. The staining matter is extract of the husks of walnut, Cassel brown, catechu, manganese peroxide, potassium chromate, gallic acid, extract of tar, etc. Black stains are used to imitate ebony, the wood of the pear-tree, lime, hornbeam and holly being suitable. Certain salts of anilin yield a black dye. [A simple method is to brush the wood over with a strong solution of sulphuric acid and water, also by boiling 1 lb. of logwood with $\frac{1}{4}$ lb. Brazil wood for $1\frac{1}{2}$ hours in a gallon of water and brushing the wood several times with the hot solution.—Tr.] Red stains are used to imitate mahogany, maple, ash, birch, alder and beech being suitable woods; alkanet (*Alkanna tinctoria*), cochineal and anilin dyes are used. Green and yellow stains are made from verdigris and anilin. Blue with indigo and anilin dyes.

Painting wood increases its durability, excludes moisture, prevents warping and conceals all its defects. Wood-paints are produced by pounding lime and coloured substances such as white lead, chalk, yellow ochre, verdigris, Prussian blue, red lead, chrome red, lampblack, etc., with oil, lac, varnish (alcohol or turpentine, with sandarac (gum of *Callitris quadrivalvis*), mastic or lac). Before applying the paint, the wood should be prepared by filling its pores and unevennesses with putty.

It may be noted that in Japan, pale birchwood is cut so that yellow and red specks and stripes, due to fungi, appear, and this improves the colour of the wood, which is then used for turnery.

3. *Improvement in Lustre.*

Polishing gives wood a permanent bright lustre, renders its texture clear, excludes humidity and prevents warping and

cracks. Solutions of lac or of Manilla copal in alcohol are rubbed on the wood. Oak parquet floors are rubbed with beeswax to make them shine. Lacquering is used for inferior furniture, by rubbing it with solutions of copal, sandarac, mastic in alcohol or turpentine; or with that of copal in linseed oil, this dries slowly but affords the most permanent lacquer. Japanese lacquering, famed for its durability, is effected by means of the latex of *Rhus vernicifera*. Woods of *Chamaecyparis* and *Magnolia* are the substrata of the best Japanese lacquered work. *Cryptomeria* wood is used chiefly for inferior goods that are exported to Europe or America.

4. *Improvement in Hardness.*

This may be effected either by hardening or by first softening the wood. The fibres of the wood are softened by boiling the wood in water, or better by steaming it under pressure; if before steaming it, the wood (*e.g.* beechwood) is steeped in dilute hydrochloric acid, it becomes, after being steamed, so soft and plastic that it can be pressed into $\frac{1}{4}$ th of its original volume. Boiling wood in saturated solutions of calcium-chloride also renders it soft and plastic. Wood may be hardened if it is painted with soluble-glass, or better still, if it is impregnated with soluble-glass by pneumatic pressure. Impregnation of wood with caustic potash or soda renders it highly resistant to atmospheric influences.

5. *Increasing the Weight of Wood.*

If increasing the weight of wood could improve its economic value, it would be quite easy to effect this, but whenever the weight and durability of wood is increased by impregnating it, the extra weight is an accompaniment that is burdensome in commerce, so that there can be no advantage in increasing the weight of the wood unless some other advantage is secured. A reduction in the weight of wood is attainable and advantageous only as long as it contains water. Once wood is dry, its weight can be reduced only by destroying its substance. Hence, where lightness is desirable, softwood instead of hardwood should be chosen, or the lightest oak-

wood instead of heavy oakwood, or veneered softwood instead of massive hardwood.

6. *Improvements in Hygroscopicity.*

In order to counteract as far as possible the evils of the varying humidity of wood, such as warping, cracking, swelling and contracting, the following remedial measures are available.

To prevent air-cracks and heartshake in logs, it has been recommended that trees before they are felled may be barked to a height of one meter and not felled until they are dead. The leaves then pump out much water from the stem. R. Hartig has, however, shown that the leaves die before the stem has lost a third of its contained water. Even the girdling of a tree down to the heartwood, which kills conifers in a few weeks, does not kill broadleaved trees till 1 to 3 years, so that in this experiment, as well as in that of leaving the crown with its foliage on a felled tree, the leaves dry up long before the stem has become appreciably dry. These practices, which appear so plausible and easy, have appeared in literature for more than a century; they were recommended even by Pliny.

Better remedies may be tried after a tree has been felled, such as partial barking the tree along the stem in pieces of a hand's width, or the removal of the bark in a spiral up the stem so as to delay the drying and the formation of cracks.

In order to prevent star-shake at the base of a log, paper may be glued on. Paper is glued on to all the surfaces of valuable exotic balks; pieces of bark may be nailed on; on pieces of thin planks of wood, grease may be laid, or carbolineum, wax, clay, petroleum, linseed oil, tar, rabelka (sebasate of alumina), soluble-glass; or S-shaped clamps driven into the wood. It is generally believed, that by washing out the soluble salts, plasma and sap of wood, not only its durability is increased, but also cracking is prevented and warping reduced. Hence floating, rafting, boiling and steaming are recommended.

Impregnating wood with various substances is a good preservative against warping, although the chief object is to render it more durable. Thorough desiccation of the wood is highly effective. Formerly this was secured by storing the

wood for years in airy places, where the wood was kept first in the open and exposed to moisture from the air, then in shady, dry chambers and finally in heated ones. At present there is not usually space enough for this, and the process is too costly, so that wood is sold either unseasoned or is **seasoned artificially**. Artificial seasoning is employed extensively in America. In **Zappert's method** of seasoning wood, planks, boards, laths, etc., are exposed to air heated to 30° C. (59° F.), while an exhauster removes the damp air; in this way dry softwoods become dry in 6 to 8 days, hardwoods in 12 to 15 days, without exhibiting cracks or any deterioration in colour, elasticity, etc. If the air is also rarefied, according to Schaffenius, the desiccation is more rapid. Wood may also be placed to dry in dry, fine sand, charcoal-dust or powdered peat. Wood intended for water-pipes is plunged in water in order to prevent cracking. After the wood is dried thoroughly, a coating of oil, paint, varnish, lac or polish, protects it from moisture, as has been described already. Warping may be prevented also, by constructing articles of **small pieces of wood**, which are fastened together (billiard cues, parquetry, drawing-boards), or spaces are left to allow for expansion (door-panels, wooden ceilings, etc.), or species of wood are selected that are known to be only slightly absorptive of water.

7. Increase in Pliability.

The pliability of wood is increased by means of moisture and heat. Bent furniture is made of steamed wood, so are felloes of wheels and curved planks in carriage-making and ship-building.

8. Increase in Durability.

There are numerous ways of increasing the durability of wood; some of them can be employed before a tree is felled. That girdling the lower part of a stem, or felling it with its crown of foliage, are not effectual has been stated already (p. 506). E. Mer recommends that a ring of bark should be removed immediately under the crown, not in order to dry the stem, but that the latter may be deprived of its sugar and

starch by the new foliage, whilst freshly formed carbohydrates cannot descend the stem; this is said to increase the durability of the wood. The question whether wood felled in summer or in winter is the more durable has been discussed since the time of Pliny (*cf.* p. 102). Of much greater importance, however, than the season of felling is the subsequent treatment of the wood (during conversion, seasoning or transport) and the kind of weather that prevails at the time of felling. As regards the latter, autumn and winter are probably the most favourable felling-periods.

Every precaution taken to secure thorough desiccation and to prevent the wood from again becoming wet (*cf.* p. 6) increase its durability. Slow desiccation of coniferous wood must increase its durability, as more rosin becomes injected naturally into the heartwood and less of the volatile turpentine evaporated. Cuncler considers that when wood is steeped in running water or floated, its soluble contents are removed and that this favours durability. This can be the case only when the wood, after removal from the water, is dried thoroughly. **Steaming** wood has a similar effect when it is dried after being steamed.

When wood is used under conditions unfavourable for its durability, those species should be selected that are highest in the scale of durability on page 100 of this book; as the sapwood is not durable it should be removed always. The surface of posts and piles in contact with the ground may be charred, which should be done by applying a blast flame to it, as placing the wood in an open fire cracks it and exposes it to the attacks of insects and fungi, or to the inhibition of rain-water. The tops of posts can be sheltered from rain by nailing on them plates of copper or zinc, a measure that is also protective for the wood-work at sea-ports against teredos, etc.

Impregnating wood with antiseptic substances is to be recommended. An extensive literature has appeared on this subject owing to the great interest in railway and mining works, street-paving, etc., and to the desire of forest-owners, that woods which are naturally of slight durability only may obtain a better market. The next section will deal with this subject as far as is necessary for Forest Utilisation.

SECTION II.—ANTISEPTIC TREATMENT OF WOOD.

I. Methods for Converting the Decomposable Constituents of Wood into Antiseptics.

According to **René's** process at Stettin, the wood is dried by hot air in a closed chamber; after the air has been exhausted, oxygen is admitted into the chamber. The oxygen that is absorbed by the wood is converted by intermittent electric sparking into ozone, by means of which the readily decomposable constituents in the wood are oxidised into terpenes and creosotes.

Haskins' process* consists in placing the wood in cylindrical waggons into an iron boiler $6\frac{1}{2}$ feet in diameter and 112 feet long (Fig. 309). After the boiler has been closed, air heated to 300 to 500° C. is pumped into it for several hours, after which the pressure is removed and the wood allowed to cool. Owing to the high temperature, sugar, gum, tannin, protein and starch are converted into the antiseptics, acetic acid, methyl alcohol, phenol, creosote, etc.; these substances amount to 12 per cent. of the weight of the wood. The process is termed **Haskinisation**, or **Vulcanisation**, and has given good results on the Manhattan Railway, New York.

II. Methods for Removing the Easily Decomposable, Soluble Constituents of Wood, and replacing them by an Antiseptic Substance.*1. Materials used for Injection.*

A number of substances have been known for a long time that render wood durable, such as resin, essential oils, camphor, tannic acid, acetic acid, heavy tar-oil (creosote); also several salts, as green, white and blue vitriol (sulphates of iron, zinc, and copper), chlorides of iron, zinc, mercury or magnesia, Glauber's salt (sodium-sulphate), common salt, etc. Only a few of them are, however, applicable on a large scale,

* According to Grady, "Rev. des Eaux et Forêts," 1896, Mayer has the prior claim to this invention.

and of these the following are at present in the front rank :— sulphate of copper, chlorides of zinc or mercury, heavy tar-oils (creosote) and milk of lime. There are also a few other substances the use of which is still only in the experimental stage.

Injection with sulphate of copper (blue vitriol) was employed in France on a large scale first by Boucherie, and has been used extensively since 1841 for building-timber, railway-sleepers and telegraph-poles. Formerly this method was used extensively by railway-companies in France, Austria, and Bavaria; this is no longer the case, though it is still employed here and there for telegraph-poles, stakes and other small pieces of timber exposed to decay. Wood injected with sulphate of copper is harder than wood in its natural condition, but is rendered more brittle and weaker by the process.

[The salt also is washed out of the wood easily and it reacts on all iron with which it may come in contact, so that iron-fastenings applied to wood so treated must be galvanised, or coated with zinc, and the wood tarred at the points of contact.—Tr.]

Sir W. Burnett, in 1838, patented a process of injection by means of chloride of zinc, which is at present used in many German, Austrian and American railways. Chloride of zinc is one of the cheapest antiseptic substances, and recent experience has proved that it is preferable to sulphate of copper.

[Chloride of zinc does not corrode iron but is said to be washed out by water; to prevent this the Wellhouse* process has been invented in America. Glue is added to the solution, which is forced into the timber, and subsequently a solution of tannin is pumped into the injecting chamber, at a pressure of 100 lbs. to the square inch, forming with the glue a leathery substance which fills the pores of the wood and prevents the washing out of the zinc chloride.—Tr.]

The use of chloride of mercury (corrosive sublimate) was patented in 1832 by the Englishman Kyan as a preservative for timber.

[Kyanising was for some time used extensively in Britain, and is useful in dry situations but useless in sea-water;

* "Engineer," Sept 11, 1891.

corrosive sublimate being a strong poison has also the drawback of injuring the workmen who are employed in handling it; it also corrodes iron and is somewhat volatile at ordinary temperatures.—Tr.]

Creosoting with heavy oils from coal-tar is employed chiefly in Britain, and is now being used increasingly in France, Germany and other countries; although the method of injection now employed is capable of improvement, it is undoubtedly superior to injection by metallic salts. Creosoted wood is hard, tough and black, much less absorptive of moisture than uncreosoted wood, and does not form chemical combinations with metals. On the Emperor Ferdinand Railway, in Austria, a mixture of chloride of zinc and carbolic acid is being used with good results.

Blythe at Bordeaux injects wood with steam containing tar-oils. [Boulton considers that no good can result from this, the light oils being too volatile to remain long in the timber; on the other hand, the injection of heavy oils in the form of vapour is prevented by their high boiling point ranging from 400° to 760° F., while timber is rendered brittle and unsafe for engineering purposes at a temperature of 250° F.—Tr.]

Stuart Monteith first used **milk of lime** to fill the pores of timber; this method has been reintroduced by Frank and is useful for preserving furniture and other woodwork under cover, but its utility is doubtful for wood in the open.

2. *Methods of Injection.*

The method of injecting wood by the various substances already referred to is as influential on the result as the antiseptic substance itself. The most important methods are:—**hydrostatic injection, pneumatic injection, imbibition by immersing or boiling the wood in solutions of the antiseptic substances.**

(a) **Hydrostatic injection.**—At first the antiseptic liquids were absorbed by the natural force of the foliage raising the sap, incisions being made with this object at the base of the stem of a standing tree. This method was abandoned owing to its impracticability [and the fact that the foliage exerts only an

upward pressure equivalent to that of 10 or 12 feet of water.*—Tr.] Boucherie discovered that a pressure of one or two atmospheres applied at the transverse section of a log is sufficient to expel the sap and replace it by another liquid.

Stems or poles, with their bark intact, are placed nearly

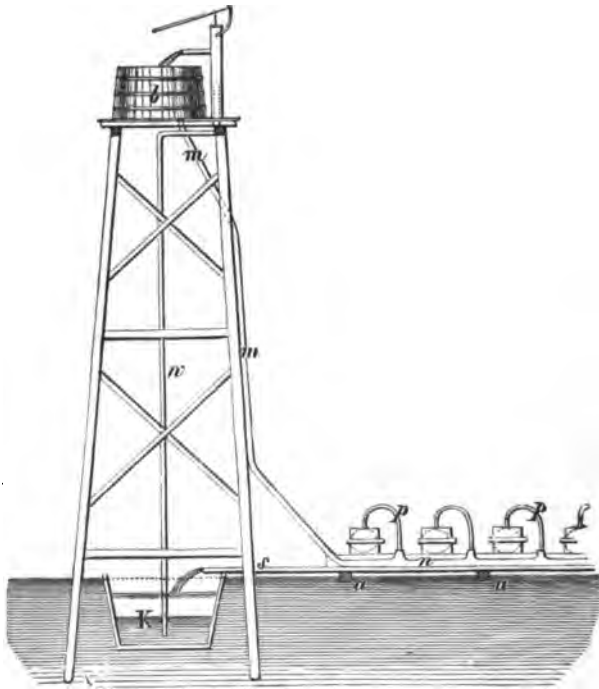

Fig. 306.—Boucherie's method of injection.

horizontally (Fig. 306, *a, a*) on a timber framework; the liquid (1 part sulphate of copper to 100 parts of water) flows from a vat *b*, which is supported on a trestle 26 to 32 feet high, passing by the pipe *m* into the conducting tube *n* under the ends of the logs, it enters the logs through the gutta-percha tubes *p*, each tube having a separate tap. In order to prevent the liquid from escaping by the anterior section of a log, a piece of hempen rope is placed round its periphery

* Boppe, *op. cit.*, p. 93.

and a board (*d*, *d*, Fig. 307) placed over the rope and pressed firmly against the log by a press *h* and two tension screws and nuts. The section of the log, the board *d* and the piece of rope placed in a ring between them, enclose a hollow space with which the gutta-percha tube communicates by means of an oblique auger-hole bored in the log. The solution of sulphate of copper flowing from the vat *d*, with a pressure due to its height above the ground, is therefore driven into the log and expels most of the sap, which issues from the smaller end of the log, at first pure but eventually mixed with the injecting solution. This waste liquid flows into a wooden trough *s*,

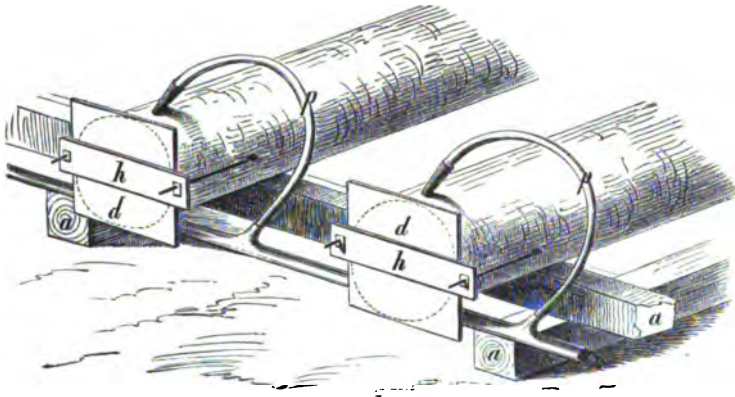

Fig. 307.—Method by injection.

and then is conducted to the tank *K*, which is provided with a filter to exclude impurities [and also a basket full of crystals of the injecting substance in order to maintain the strength of the solution—Tr.]. The liquid in *K* is then pumped back into the vat *b* by the pump *w*. Instead of forming the hollow space at the base of the log by means of a piece of rope, Oesau used a metallic vessel like a round, shallow box, the sides of which are sharpened so that they can be driven into the base of the log with a few blows of a hammer, whilst there is an orifice in the base of the box into which the tube *p* is screwed.

[Boppe states that long logs in France are injected by being sawn nearly across at their middle (Fig. 308), so that a

thickness of only $1\frac{1}{2}$ to 2 inches of wood is left below, then the log is raised by levers, and a piece of rope inserted in the opening. On removing the levers, the log returns to its former position, and the cut closes tightly on the rope; an auger-hole is bored obliquely through the log into this hollow space, and the gutta-percha tube placed in it as before.—Tr.]

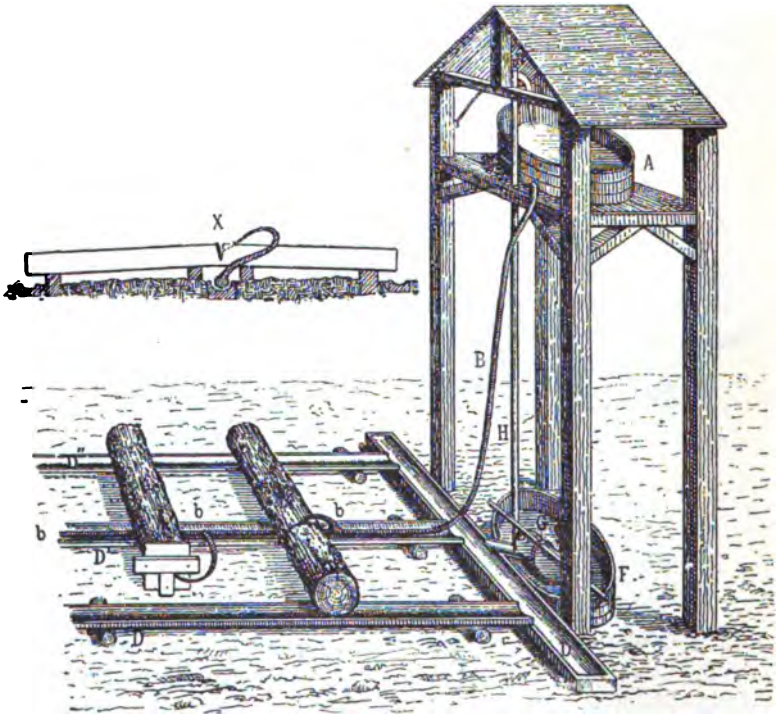

Fig. 308.—French method of injection. After Boppe.

Wood to be thus injected should be freshly cut, and still full of sap. Stems therefore are topped, branches cut down to short snags, the bark left uninjured and the injecting process applied as soon as possible. If the base of a log has dried it should be cut again freshly before being injected. Logs kept in water for a long time preserve the faculty of being injected.

[The free ends of the logs are tested, either by their colour

or by a chemical test, to ascertain when the injection is sufficient.—Tr.]

In order to inject logs satisfactorily by Boucherie's process, a long time (up to 70 hours) and a large timber-yard are required. The injected logs are dried slowly and as thoroughly as possible, then they are barked and converted.

When freshly felled stems are injected, the bark must be preserved completely or the injecting liquid will escape. If, however, they have been kept for about three months, the preservation of the bark is not material, as the sapwood dries for a few centimeters down and becomes impermeable for liquids.

Another improved method based on that of Boucherie is that carried out by Pfister.* Instead of pressure due to a fall of about 30 feet, Pfister used a portable forcing-pump producing a pressure up to 20 atmospheres, he thus drove the injecting liquid through tubes into the wood, the tubing being arranged so that it can be lengthened at discretion or conducted at the same time to several logs. The advantages of this method are, that the injection is effected more rapidly than by Boucherie, and in the forest immediately after the felling of the trees or poles without any necessity for transporting them to the injecting works.

Pfister's apparatus will inject thoroughly a beech-butt 10 feet long in about half an hour, it being immaterial whether the bark is damaged or not. He also devised an improved method of enclosing the base of the logs. The apparatus, with several closing pieces of various sizes, costs from £200 to £300.

(b) **Pneumatic injection.**—Antiseptic substances can be injected into wood more effectually by means of a forcing-pump than by the hydrostatic method, the process being conducted much more rapidly; at present in Germany pneumatic injection is employed exclusively in the case of chloride of zinc, creosote, acetic acid, etc.

In this case the wood is converted into beams, scantling, railway-sleepers, etc., and they are placed in large iron cylinders (A, A) containing the injecting fluid, which, at

* Dimitz und Bohmerle, "Centralblatt des gesammten Forstwesens," Vienna, 1889.

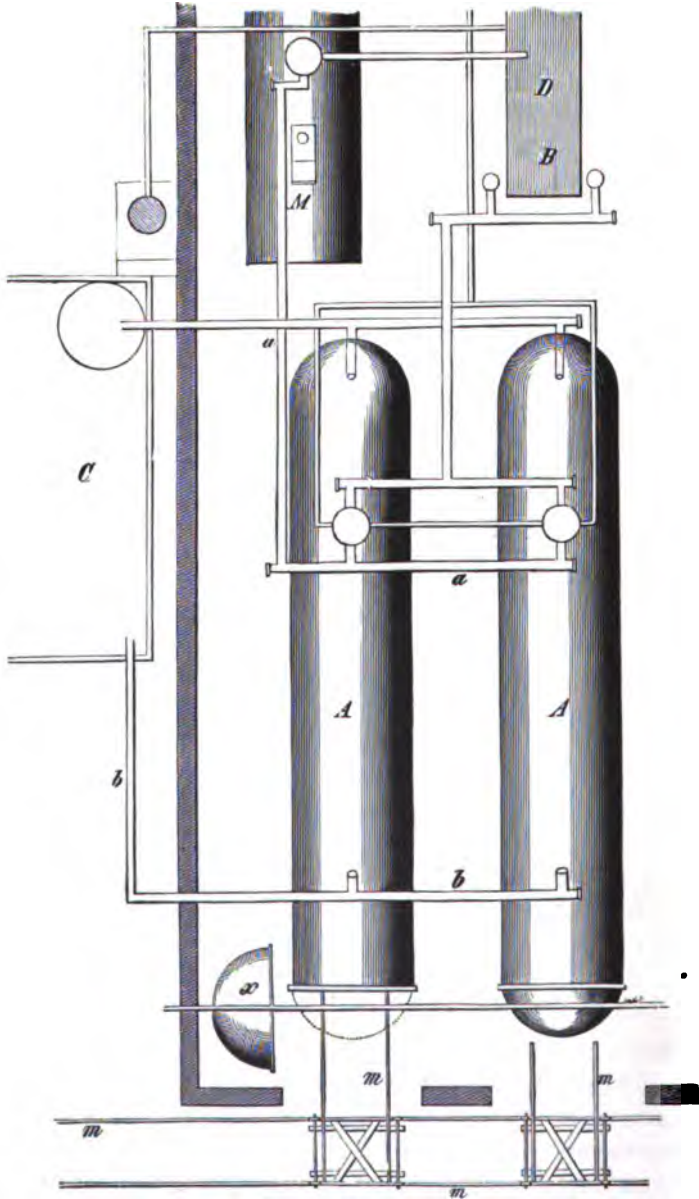

Fig. 309.—Creosoting cylinders.

temperatures of 112° to 194° F. (50° to 90° C.) is pressed into the wood by powerful steam forcing-pumps.

The pieces of wood to be injected are packed as tightly as possible on the trucks (Fig. 310), and the latter are pushed along a tramway (*m, m*, Fig. 309) into the cylinders *A, A*. When the cylinders are full, the rails leading to them are removed, and the head *x* adjusted and fixed firmly so as to close the cylinder. The wood is first steamed at a temperature of 112° C. (234° F.) for one hour; the steam is conducted from the boiler *M* through the steam-pipe *a*. When the steaming process is concluded, the air is sucked out of the wood by means of the air-pump *B* and the injecting liquid (30 to 50 fold diluted chloride of zinc, the latter containing 25% of zinc) is admitted through the pipe *b b* into the cylinders, the air-pump still working for some time. When the cylinder is full, the forcing-pump *D* presses the liquid into the wood.

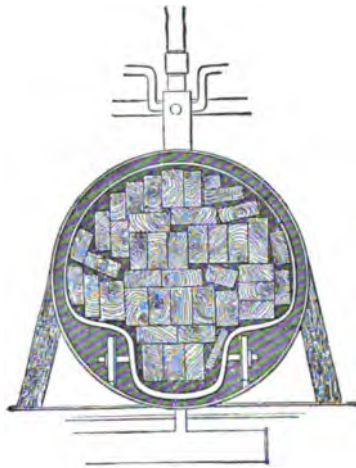

Fig. 310.—Front of an injecting cylinder with a truck laden with wood.

In order to effect this, a pressure of about 6 atmospheres is applied for $\frac{3}{4}$ to $1\frac{1}{4}$ hours. The injecting liquid is then drawn back into the reservoir, and the truck removed with its contents. The two cylinders are used alternately.

Quite recently it has become the practice to omit the steaming entirely and to dry the wood, especially in creosoting with tar-oil, etc. This method is employed in Berlin and also by the Great Northern Railway, Ireland. The drying is effected in a drying-chamber, heated to 177° or 267° F. The wood is then placed in the injecting cylinders, out of which the air is drawn, and the tar-oil admitted at a temperature of 113° to 140° F. (45° to 60° C.), and pressed into the wood in the same way as when chloride of zinc is used.

[Boulton * says that the presence of water in timber at the time of creosoting is most prejudicial to successful injection, and that railway-sleepers and other timber should be stacked and dried for several months before injection. This precaution can be secured easily in the case of railway-sleepers or telegraph-poles, but when timber is sawn from logs kept in timber-ponds in the docks, it is difficult to afford a proper time for stacking and drying it before creosoting. Owing, however, to the injury done to timber by drying it artificially at temperatures up to 250° F., the action of stoves in closed chambers, or of superheated steam, is very prejudicial; he therefore considers 230° F. as the limit of safety for heating timber intended for engineering purposes. Boulton has therefore patented a process depending on the different boiling points of water (212° F.) and of heavy tar-oils (350° F. to 700° F.); the creosote is admitted at a temperature slightly over 212° F. and the action of the air-pump continued, so that any water in the logs is converted into steam and drawn off by the air-pump through a condensing worm in a dome on the top of the injecting cylinder. The creosote is still liquid at 212° F. and replaces the water in the log, which is not then subject to any excessive heat, and consequently its tissues are uninjured. Boulton also maintains that in the case of railway-sleepers to be used in India and other hot countries, this injecting at a temperature of 212° F. fills all cracks in the wood with creosote; as in India therefore the sleepers will not be subjected to such a heat in the ballast, they will not crack any further there, which is not the case with sleepers injected at a heat less than that they may experience in Indian ballast.—Tr.]

When heavy tar-oil is used for injecting purposes, the wood is coloured dark black; the hard, pitchy components of the tar form a crust almost as hard as stone on the surface and fill all the crevices of the wood. [In England about 50 gallons of heavy tar-oil are used per load of 50 cubic feet, the oil weighing 11 lbs. per gallon.—Tr.]

F. Löwenfeld has designed a portable apparatus for injecting

* S. B. Boulton, "An improvement in the process of Creosoting Timber."

wood, which is based on the principle of first steaming the wood and then injecting it by forcing-pumps in chambers deprived of air. There are six of these chambers, which can be connected successively with the steam-generator, and in which the process of injecting is carried on continuously, the sixth chamber being removed and charged with wood, the first chamber steamed, and so on.

In Blythe's system (according to Gayer) the wood is dried artificially and then placed in boilers, where it is subjected to a high pressure of steam containing heavy oil of creosote in suspension. The wood is subjected to injection during 6 to 20 hours; it is injected completely, and assumes a dark colour like that of several tropical woods. The softened wood is rolled and pressed till it is reduced in thickness by 10 % or even 40 %. The effect of the injection is increased by compressing the wood, and thus a very superior kind of furniture-wood is produced (Exner). It is preferable to use freshly felled wood, and Exner states that beechwood thus injected and compressed gains up to 19 % in strength.

III. Steeping Converted Wood in Antiseptic Liquids.*

This method is employed chiefly for kyanising stakes and small pieces of wood. Large wooden troughs like cooling-troughs are partly filled with a solution of 1 part of corrosive sublimate to 150 parts water; railway-sleepers, telegraph-poles, etc., are placed in them, weighted to make them sink, and kept from 8 to 10 days immersed. The solution penetrates only 2 mm. into the wood, which cannot be altered in shape after immersion.

[Boulton says that small pieces of wood, hop-poles, fencing-slabs, stakes, etc., may be placed in an open trough with heavy tar-oil, which is heated by a fire under the trough, care being taken not to raise the temperature of the creosote above 230° F.—Tr.]

Other methods by immersion give inferior results. Formerly

* Cf. E. Henry, "Préservation des Bois contre la Pourriture." Berger Levrault et Cie, Nancy. 1907.

the wood was frequently boiled in antiseptic liquids, steam being introduced into the vessel in which the wood was immersed until the liquid in it boiled. Blue vitriol, borax solution, etc., were thus injected, but the liquid must be kept at the boiling point for 10 or 12 hours.

Recently H. Liebau, in Magdeburg, has attempted to introduce the liquid from the interior of the pieces of wood instead of externally, in order to protect the heartwood from decay. This method can be used only for stakes, piles, etc., the axis of which is bored through after they have been driven into the ground, and tar-oil, pitch, etc., poured into the cavity. Nothing as yet can be said regarding the efficacy of this method.

[Boppe states * that in France, mining pit-props are immersed for about 24 hours in solutions of $1\frac{1}{2}$ lbs. per gallon (150 gr. to 1 liter) of sulphate of iron, or in wood-tar heated to a temperature of 278° F. (140° C.), in order to render them more durable. It is found that if the immersion is continued for a longer period, the wood becomes brittle, and that chloride of zinc, blue vitriol or creosote poisons the wood and renders it dangerous to the miners.—Tr.]

Another plan is to place telegraph-posts in a glazed, burned clay tube filled with sand and tar; or cement and tar are poured round the base of the wood in the ground.

W. Powell, of 6, Stanley Place, Liverpool, noticed that dry rot never occurs in the wood used in sugar-refineries, and in 1908 invented a process in which timber is saturated with a solution of sugar, and then the moisture evaporated rapidly by stoving at a high temperature. The process requires 2 or 3 days only. Powell finds that this processed timber cannot be infected with dry rot. He experimented with paving blocks, 3 inches by 5 inches by 9 inches, of red pine, poplar, beech and red-gum, and found that they gained respectively 1 lb., 5 lbs., 4 lbs. and $\frac{1}{2}$ lb., their original weights being 4 lbs. 12 ozs., 4 lbs. 11 ozs., 7 lbs. 7 ozs., and 8 lbs. 13 ozs.

As regards absorption of water, beech in a natural state absorbs 1 pint of water per block, but processed beech

* "Technologie Forestiere," p. 97.

only $\frac{1}{2}$ pint and less than half the amount of water absorbed by red-gum. As street paving-blocks absorb much ammonia and emit an offensive odour this process is a sanitary one, as well as affording superior durability from hardening.

3. *Suitability of different Wood for Injection.*

The species of woods are susceptible of impregnation in the following order:—

| Thoroughly. | Partially. | Slightly, or not at all. |
|--|--|--|
| Birch. Hornbeam. Beech. and sapwood of all species. | Aspen. Alder. Ash. Elm. Lime. Silver-fir. Spruce. Scots pine. Weymouth pine. | Heartwood of Oak. Larch. Mahogany. Teak. Ebony. Red beech-wood. |

The question as to the comparative ease or difficulty with which a piece of wood can be injected and whether the injection is thorough, or merely superficial, cannot as yet be answered satisfactorily. As a rule, a thorough injection is rare; in most cases the antiseptic liquid injects merely the sapwood and younger woody zones; in the case of railway-sleepers which are injected pneumatically, it also passes into the two ends of the sleepers, whilst the heartwood in the centre is often only partially injected. There are, however, many modifications in the above condition of injected wood, according to the species of wood, its soundness or unsoundness, special anatomical structure and amount of contained resin, which differs greatly in individual cases.

The more resinous a wood the less easily it is injected, and much resin in the wood may prevent injection entirely, as for instance in pinewood; it has not been ascertained whether the different injecting processes affect matters in this respect.

Beechwood with reddish false heartwood (from trees over 100 years old) is quite unsuitable for injection. It is not known yet whether variations in the specific gravity of the same wood

affect matters in this respect ; this question should be decided experimentally.

4. Results of Injection.

As regards the results of injecting railway-sleepers, it is evident that the locality, nature of the soil and wear-and-tear on a railway must be considered in judging their durability. The method of injection, the anatomical structure of the wood and whether the injected wood is used immediately after injection or is first kept some time in store, also affect its durability.

As regards the methods of injection, the following are the results given by experience on German Railways :—

| Nature of antiseptic substance. | Method of injecting. | Life of sleeper in years. | | | |
|---------------------------------|----------------------|---------------------------|-------------|--------|---------|
| | | Oak. | Scots pine. | Beech. | Spruce. |
| Chloride of zinc ... | Steam-pressure | 19—25 | 22·8 | 13—15 | — |
| ” ” ... | Immersion | — | — | — | 6·6 |
| Creosote ... | Steam-pressure | 19·5 | — | 18 | — |
| Sulphate of copper ... | Hydrostatic pressure | — | 16 | — | — |
| ” ” | Immersion | — | 14 | — | 9·6 |

Other investigations give the following data for the duration of railway-sleepers :—

| Species. | Years. | Per Cent. of sleepers useless. |
|------------------------------------|--------|--------------------------------|
| Beech, not injected | 5 | 100 |
| ” with zinc chloride | 11 | 50 |
| ” creosote | 17 | 50 |
| Oak, not injected | 13 | 50 |
| ” zinc chloride | 13 | 28 |
| ” creosote | 13 | 20 |
| Scots pine, not injected | 12 | 100 |
| ” ” zinc chloride | 12 | 23 |
| ” ” creosote | 12 | 14 |

In Elsass-Lothringen.

| | | |
|-----------------------------|----|------|
| Oak, not injected | 21 | 52 |
| ” creosote | 21 | 26·8 |
| Beech, creosote | 21 | 6·4 |

The greater durability of beech is due to the fact, that it absorbs more creosote than oak, but its injection is necessarily more costly.

Thus with creosote:—

| | | | Cost. | |
|--------------------------|---------|--|-----------|-----------|
| | | | <i>s.</i> | <i>d.</i> |
| An oak sleeper absorbs . | 22 lbs. | | 1 | 3 |
| A Scots-pine sleeper „ . | 79 „ | | 2 | 4 |
| A beech sleeper „ . | 79 „ | | 2 | 4 |

So that including the cost of the wood, oak sleepers cost 4*s.* 8*d.* and beech sleepers 4*s.* 5*d.* each.

Injection with copper sulphate increases three-fold the durability of spruce and silver-fir.

The **Nodon-Bretonneau** method of seasoning wood by electricity was tried in London several years ago, but did not give satisfactory financial results. The system consists in placing the timber to be seasoned in a large tank and immersing all but an inch or two in a solution containing ten per cent. of borax, five of resin, and three-quarter per cent. of carbonate of soda. The lead plate upon which it rests is connected with the positive pole of a dynamo, the negative pole being attached to a similar plate, arranged on its upper surface so as to give good electrical contact, and the circuit is completed through the wood. It is stated that under the influence of the current the sap appears to rise to the surface of the bath, while the aseptic borax and resin solution takes its place in the pores of the wood. This part of the process requires from five to eight hours for its completion, and then the wood is removed and dried either by artificial or natural means. In the latter case about a fortnight's exposure in summer weather will complete the process.

SECTION III.

ALTERING THE COMBUSTIBILITY OF WOOD, ETC.

The combustibility of wood is increased always by drying it. Absolutely dry wood has the greatest heating-value.

When coniferous wood is dried slowly, the percentage of heat-giving rosin increases at the expense of the volatile turpentine. As regards the relative increase in heating-power by the carbonization of wood, see the next chapter.

In order to reduce the combustibility of wood and produce so-called unflammable wood, the following substances may be smeared on it, or injected. Lime-water, clay in a saturated potash solution painted on the wood in several coats. Alum, soluble-glass, five to six coatings. Wolframate of soda is effective, but costly. Hot solutions of green vitriol and iron. Kyanised wood also is said to be unflammable. The best methods are, however, commercial secrets.

[Wood processed by the **Non-flammable Wood Syndicate**, 2, Army and Navy Mansions, Victoria Street, London, was tried recently on the site of the old Millbank Prison and two constructions erected of injected and uninjected wood; all efforts to burn the former failed. The substance used is colourless and harmless, it does not rot, does not affect the strength of the wood, but adds slightly to its sp. weight. It is difficult to distinguish the wood which has been injected, which is to a large extent protected from being worm-eaten and from dry rot. The action of tools on the wood is not rendered more difficult. The wood is used extensively in America and Japan; also for the British Navy and South Kensington Museum.—Tr.]

Artificial wood. Soft and plastic substances resembling wood are in demand to fill in defective places in valuable wooden articles. The less valuable articles are filled in with putty. Instead of putty the following substances are used: glue, saw-dust and chalk, lime and flour, lime-water and soluble glass. Softened cellulose mixed with starch or flour can be made into tabular shape, and in time becomes as hard as a bone. It may be pressed into shape between heated and embossing-presses. If a thin sheet of veneer is placed between the artificial wood and the press, the pressed article appears to be carved out of valuable wood. Caustic soda or rosin may be mixed with the preparation to increase its durability.

Wood-wool under powerful compression yields a homogeneous, rigid mass. Artificial kindling fuel is made of wood

shavings and resin, or coal-tar. Artificial wood is made of peat mixed with lime and sulphate of alumina in solution.

C. CHANGES IN THE SUBSTANCE OF THE WOOD IN ORDER TO OBTAIN ITS CONSTITUENTS.

SECTION I.—BY HEAT.

The first chapter on the properties of wood explains the action of heat on wood. Where wood is burned and oxygen admitted freely, light, heat and gases (CO_2 and H_2O) are produced; combustion is maintained by the hydrocarbon gases, light by the glowing of the charcoal, and ashes form the residue. If the wood is burned without free admission of oxygen, it is said to be roasted with dry distillation, under which are preserved gases and carbon, with numerous other products of incomplete combustion, all empyreumatic substances of great economic value.

Although properly an account of these substances does not come under the direct activity of a forester, yet he should possess a general knowledge of the products of distillation of wood, as well as of all matters which bear on the sale and value of wood, the chief product of his calling.

1. *Distillation of Wood.**

The apparatus for distilling wood varies with the products to be obtained from it. If gas and volatile products are required, the wood should be roasted in vessels with open tubing from which those products can escape, in order to be received in a refrigerator, or to pass through it purified. Such apparatus consists of boilers, retorts and stoves. If heavy liquids and solids are the chief desiderata, the wood is usually piled in large covered heaps, charcoal-kilns or pits.

When wood is distilled in retorts or vessels, according to Violette, the decomposition of the wood begins at a temperature of 160°C .; the condensed vapours yield a yellowish, aromatic, bitter liquid. At 280° the weight of this liquid is 64% of the weight of the original wood; products that are

* J. Bersch "Die Verwertung des Holzes auf chem. Wege," 2nd ed. 1893.

obtained between 150° and 280° are the most valuable, and are chiefly sebacic acids, such as formic, acetic, propionic, valerianic, caproic acids, then methyl-alcohol, carbonic acid and carbon monoxide. Between 280° and 360° chiefly carbohydrates are formed; they take up much space, as 1 cub. meter of wood yields 80 to 90 volumes of gas. The products of heating over 360° are dense carbohydrates (tars), such as benzol, toluol (methyl-benzene), carboic acid, paraffin, and the gases acetyl, ethyls, marsh-gas and hydrogen. By heating over 430°, there is a small volume of the above-named substances, whilst charcoal remains as a solid residual product.

In every case, when quite pure, hydrated acetic acid is a colourless liquid, combustible, very caustic and with a strongly acid odour; at 4° C. acetic acid becomes solid, but lignifies at 16°; after absorbing water it loses its power of crystallisation; hydrated acetic acid is soluble in water, alcohol and ether. Wood yields 2 to 6% of its weight in pure acetic acid, which is used extensively for making vinegar. In wood-vinegar there is always some acetone, a combustible liquid in which oils, resin and gun-cotton are very soluble; it is now used in the manufacture of smokeless powder.

Pure methyl-alcohol or pyroligneous spirit is a colourless liquid, in which resin and ethereal oils are very soluble, so that it is highly important in preparing lacquers and varnishes; after further distillation pure methyl-alcohol is used for making tar dyes.

The gas distilled from wood, 80 cubic meters from a stacked cubic meter, owing to admixtures of CO₂ and CO, requires purifying by means of lime. [In France charcoal is placed at the base of the retort in which the wood is distilled, and the gas passes through the charcoal into a reservoir. This is said to purify it sufficiently.—Tr.] According to Pettenkofer the volumes of illuminating wood-gas produced by distilling 100 kilos (220 lbs.) of wood are:—

| | Cubic meters. | Cubic feet. |
|----------------------|---------------|-------------|
| Willow | 88 | 1,380 |
| Silver-fir | 86 | 1,260 |

| | Cubic meters. | Cubic feet. |
|----------------|---------------|-------------|
| Birch | 35 | 1,225 |
| Oak | 34 | 1,190 |
| Beech | 33 | 1,155 |
| Spruce | 33 | 1,155 |
| Larch | 32 | 1,120 |

Wood therefore yields $2\frac{1}{2}$ times as much gas as does coal, and the lighting power of wood-gas is to that of coal as 118 : 100.

Broillard states (Rev. des E. et F. 1900) that Riché, by passing out the wood-gas through glowing charcoal, has succeeded in obtaining from 350 to 400 cubic meters of gas from 100 kilos of wood. Any wood, coppice-shoots, etc., will do, and the apparatus is so simple that it can be set up in any village or farm where there is plenty of refuse wood.

Neutral (non-acid) tars are used for making dyes, for which hitherto chiefly coal-tar has been used. Acid tars (creosote and carbolic acid) are powerful antiseptics. At ordinary temperatures solid naphthaline is a constituent and is a certain remedy against the clothes-moth, also paraffin, but the latter is obtained usually from raw petroleum.

Charcoal is a residual product from distillation in stoves and retorts, but is the chief product in the woods from charcoal-kilns and pits, whilst the gaseous and liquid products are then either neglected or only of secondary importance. In the following pages the process of charcoal-making will be described shortly.

SECTION II.—CHARCOAL-KILNS.*

A charcoal-kiln is a heap of firewood of a regular shape, and with a covering as effective as possible for keeping the fire inside the kiln and excluding atmospheric air.

The shape is generally that of a paraboloid and only in certain cases that of a horizontal prism. Wood may be piled in kilns either vertically or horizontally, and as these methods of piling the wood, as well as the external form of the kiln,

* The best work on charcoal-kilns is v. Berg's "Anleitung zum verkohlen des Holzes," 3rd ed., 1880.

give rise to considerable differences in the process of charcoal-making, vertical and horizontal kilns will be described separately.

In vertical kilns, the wood is piled nearly vertically around stakes in the middle of the kiln, so that the latter assumes the shape of a paraboloid. Horizontal kilns are distinguished from the former kind by their prismatic shape and by the fact that the charcoal is removed from them gradually as the wood becomes carbonised.

Although the comparison between these methods will follow at the end of the chapter, here it may be mentioned that the vertical arrangement of the wood is that followed usually, as experience shows that it gives the best results. A further distinction depends on whether the kilns are made in the forest and consequently in different places every year as the felling-areas change, near iron-furnaces and other works using charcoal, or in large kilns away from the forests.

It is evident that in the last case greater care can be taken and better results will follow than when kilns are burned in the forest, frequently under very unfavourable conditions. In spite of this disadvantage, however, forest charcoal-kilns are more economical, as will be seen hereafter.

1. *Paraboloidal Charcoal-kilns.*

There are two methods of making charcoal that do not differ much from one another—they are the common method and the Alpine or Italian method. The former is practised all over Central and Western Europe, except parts of Styria, the Tyrol, Lower Austria and Lower Bavaria.

(a) **The Common Method of Charcoal-making.**

i. *Wood used for Charcoal-making.*

Charcoal-making is a much more important industry in mountain-districts stocked with coniferous forest than in broadleaved woods. Whilst in the latter—only the less valuable fire-wood, round billets from early thinnings and stump-wood are carbonised—in coniferous forests, frequently

the best class of firewood and even timber may be used for this purpose, according to the demands of neighbouring works for charcoal.

Any species of wood may be carbonised, but the method employed varies with its density and greater or less combustibility. If two kinds of wood are placed in the same kiln one of which must remain some time burning in the kiln until the other is carbonised, the former might be burned to ashes before the latter can be removed. It is therefore advisable to pile only one species of wood at a time in a kiln; if different species must for any reason be burned in the same kiln the precaution should be taken to restrict these to hardwoods or softwoods only, or to split the harder woods and place them in the centre of the kiln, where the heat is greatest. It is, however, always better to separate the woods, as charcoal made from different species is used for different purposes.

As regards the comparative soundness and dryness of wood for charcoal-making, it is customary to use only sound air-dried wood, and not dead wood. Rotten wood is useless for the purpose, and must be excluded carefully. Carbonising broken billets is a difficult process, as the pieces continue to glow for a long time and may set fire to the kiln during the removal of the charcoal.

All wood for carbonisation should be spread out in dry parts of the felling-area or of landing depots until it is air-dry, in order that there may be the least possible waste of heat in driving off moisture from the wood. Only in very hot summers, or when the wood is highly resinous, is it advisable to use somewhat green wood so that the process may not be too rapid, or else the workmen may not be able to keep the combustion of the wood well in hand.

The shape and dimensions of the billets have considerable influence on the process of carbonisation. Although all parts of a kiln do not burn at the same rate, yet it is advisable to have the billets as uniform in shape as possible. As a rule, therefore, only one assortment of wood is used in a kiln; only in cases of necessity, in very large kilns or in carbonising stump-wood, should deviations from this rule be allowed. One of the chief points of difference between the common and Alpine methods of carbonisation is that, in the former

generally the wood is split and used in small pieces, large pieces of wood being used in the latter.

The length of the billets may be either that usual for fire-wood, or a special length may be given to charcoal-billets (rarely exceeding 6 feet). The shorter the pieces the easier it is to give the kiln its requisite shape, and the less the cost of its construction. Excepting small round billets under $2\frac{3}{4}$ inches (7 cm.) thick, the wood should all be split; stump-wood also should, as far as possible, be split into small pieces. This is especially necessary for broadleaved woods, which burn slowly. In order that the wood may be packed closely, all snags and unevennesses should be trimmed off, and fairly smooth, straight pieces set aside on the felling-area for charcoal-making. Crooked and bent branchwood is used only in short pieces. In piling the kiln, besides the round and split billets, short little pieces of wood are used to fill interstices between the billets.

ii. *Shape and Size of Kilns.*

The usual shape of a kiln is that of a paraboloid, the volume of which is $\frac{d^2}{4} \pi \times \frac{h}{2}$, where d is the diameter and h the height of the kiln; or, as it is easier to measure the girth than the diameter of completed kilns, $\frac{g^2}{\pi^2} \times \frac{\pi}{4} \times \frac{h}{2} = \frac{g^2 h}{8 \pi} = \frac{g^2 h}{25 \cdot 13}$. As, however, the shape of a kiln is usually not quite a paraboloid, but somewhat steeper and more pointed, 4 to 6 per cent. may be deducted. Some useful tables* have been prepared for the cubic contents of kilns. It is easy to calculate the volume of a kiln whenever wood already stacked is used.

Kilns vary greatly in size in different districts; sometimes, as in the Spessart, Thuringia, etc., they contain only 400 to 700 stacked cubic feet (12 to 20 st. cub. meters), whilst in the Harz they may be five times as large, and ten times as large in the Alps. In the common method a kiln of 1,000 to 1,400 st. cub. feet gives the best outturn and is easiest to manage.

* Böhmerle, "Tafeln zur Berechnung der Kubicinhalte stehender Kohlenmeiler." Berlin, Paul Parey, 1877.

iii. *Site for a Kiln.*

The site for a kiln should be level, sheltered from winds, with water at hand, and either on the felling-area or close to it. Where several hundred stacks of firewood are to be carbonised there should be room for several kilns close together to save the cost of transport. The nature of the ground below the kiln has considerable influence on its rate of burning; if the soil is loose and porous it admits air to the interior of the kiln, which will burn rapidly and yield heating charcoal; if the soil is heavy, the kiln will burn slowly and yield cold charcoal. A sandy loam is most suitable, as it allows a moderate inlet of air, being at the same time porous enough to absorb the moisture, which descends from a burning kiln. The soil should be of uniform nature under a kiln, in order that the inlet of air and the rate of carbonisation may be uniform throughout.

A new site for a kiln is prepared as follows: the ground is freed from all sticks, roots and stones; the grass-sods are then dug up and the soil prepared as smoothly as for a garden-bed. The soil must be freed carefully from all stones likely to heat any part of the kiln excessively. The site is levelled, a stake driven in at its centre and a circular line traced as the boundary of the kiln. The centre is raised 8 to 12 inches (20 to 30 cm.), the higher the stiffer the soil and harder the wood, the site being made to slope off from the centre in all directions towards the external circular line. This arrangement is intended to increase the inward draught of air and allow the liquids from the burning kiln to drain away, also that the piled billets may stand on an edge and not on their section. The site is trampled down firmly and remains lying unused for some time, generally during winter, in order to settle and allow for any improvement that may be required. Before piling the kiln, a heap of dry firewood should be burned on the site to dry it.

However carefully a new site may have been prepared, it is always inferior to one used repeatedly for kilns. The loss of wood in using a new site may amount to from 10 to 17 or

even 25% (according to v. Berg). The reason for this is that charcoal dust mixed with earth gives the proper degree of porosity to the soil that is most advantageous for charcoal-making. The charcoal-burners, therefore, always prefer old sites for kilns, and changing a site is always disadvantageous.

Although as far as possible suitable sites are chosen for kilns, yet in mountainous forests it is often necessary to make one on a slope, in a narrow gorge or other unfavourable place. Then an excavation is made in the hill-side and an embankment formed downhill so as to secure a horizontal site. It is then better to support the lower side of the site by wattle-work, or logs may be piled on one another and covered with earth to form the lower side of the site. Kilns made on sites like these always have a draught in one particular direction, which the burners must try to counteract by various devices whilst the kiln is burning. There must be round the kiln a clear space sufficiently large for the burners to work in and affording room for the charcoal-burners to stack the wood, also for a hut and so on.

iv. *Erection of the Kiln.*

At the centre of the kiln is a flue, which is constructed of three or four stakes driven into the ground about one foot apart. They are bound round with withes, forming a hollow shaft, which is filled with very dry, combustible firewood. The way in which the latter is inserted depends on whether the kiln is to be kindled from above or below. In the latter case a dry board is placed under the flue to keep back the soil-moisture; highly combustible fuel, such as pieces of resinous wood, shavings, birch-bark, etc., are then placed upon the board, the upper part of the flue being filled somewhat loosely with broken branches, half-burned bits of wood, shavings, etc. When the kiln is kindled from above, the flue is filled in the reverse manner.

The flue once filled, finely split pieces of dry wood and partly carbonised billets are placed around it, the spaces between them being filled with wood-shavings, and then the regular kiln is constructed. This is done by piling two tiers of billets, the burner placing dry pieces of wood as closely as

possible round the shaft, with their split sides inwards, followed by larger pieces, so that at a distance of about half the radius of the kiln the thickest pieces, which burn most slowly, are placed, and smaller billets outside these, as shown in Fig. 311. After some progress has been made in the lower

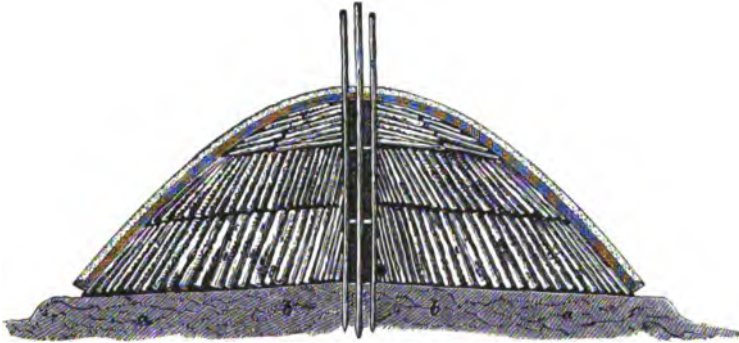

Fig. 311.—Section of charcoal-kiln.

tier of billets, the upper tier is commenced and the two tiers continued together till the kiln has attained its full circumference.

If the kiln is to be kindled from below, a kindling-passage

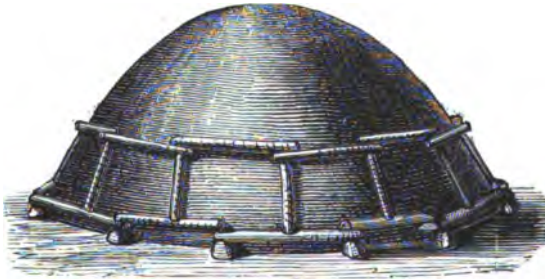

Fig. 312.—Vertical kiln with supports.

is left communicating with the flue ; this is effected by placing on the ground from the opening in the flue to the edge of the kiln a thick log, which is gradually drawn away during the piling of the lower tier, leaving a hollow passage. The billets placed above this log should be somewhat shorter than the

rest, so as to secure a level surface to the lower tier. This passage should be exposed always to windward, but is not required if the kiln is kindled from above.

When the two tiers of billets are piled the top of the kiln is filled in, as shown in Fig. 311. For this, the wood, which should be composed of small dry pieces, is laid very obliquely or horizontally. When the kiln is kindled from below, its whole top, including the flue, is thus covered; but when the kindling is effected from above, the flue runs through the top of the kiln.

Although the burners endeavour in piling the billets to place them as vertically as possible, as they are piled with their thick ends downwards they become gradually inclined outwards, so that eventually the outside of the kiln acquires a slope of 60 degrees or 70 degrees. This slope is necessary to support the covering of the kiln, being greater or less according to the state of the weather: during summer, in dry weather, it cannot be so great as in damp weather, whenever the covering does not dry very rapidly, a steeper slope is permissible.

The charging of the kiln is completed by carefully stopping all openings and crevices with small split pieces of wood, in order to prevent too great a draught and save the covering from collapsing.

v. *Supporting and Covering the Kiln.*

The next step is to apply the covering, which should be as air-tight and fire-proof as possible. Two coverings are applied, termed the *inner and outer coverings*; in order that they may not collapse they are supported by pieces of wood, termed the *upper and lower supports*. Every kiln requires at least the latter, which are formed of stout, short, forked pieces of wood driven into the ground all round the edge of the kiln; they may be replaced by a row of stones as big as one's head, on which split billets are placed contiguously in a circle a few inches from the ground for the covering to rest on and to admit air to the kiln. In some districts iron supports are used, shaped like circular segments with a prop at one end of

each piece; these are placed all round the kiln and are very durable.

The upper supports form a similar circle higher up the kiln, resting on vertical billets or forked pieces of wood; they are placed in position after the kiln is covered. In some districts a third circle of supports is added, but that is not usual.

The material used for the inner covering of the kiln consists of sods, leaves, moss, spruce or silver-fir branches, ferns, rushes, broom, heather, etc. Thin sods placed like tiles overlapping one another form the densest covering, and leaves or silver-fir branches also afford a dense covering. The covering is applied first to the top of the kiln, and should be thick enough to prevent the earth of the outer covering from penetrating through it.

The outer covering consists of a wet mixture of loamy forest soil and charcoal-dust, the remains of former kilns, for which fresh humus may be substituted. These substances should be mixed thoroughly with a hoe, freed from all stones, and water added to form a stiff paste, which must have sufficient consistency to serve as a dense coating to the kiln without becoming quite crusted by the heat, remaining soft enough during the burning to yield without cracking to the gradual sinking of the kiln, and to allow the steam to escape.

This paste is applied first at the foot of the kiln, then the upper row of supports are placed over it and the paste continued up to the top of the kiln, being applied more thickly there than below. The total thickness of the covering is 0·7 m. at the base and 0·3 m. at the top, somewhat less round the flue.

After the kiln is covered, a wind-break is placed around it at a sufficient distance to allow room for the men to manage the kiln; it is made usually of coniferous branches at least as high as the kiln and fastened to stakes driven into the ground; this may be dispensed with in thoroughly sheltered places.

vi. *Kindling and Burning the Kiln.*

If the kiln is kindled from below, one of the burners applies a torch made of resinous wood-splinters through the kindling-

passage to the kindling material at the bottom of the flue, that is thus fired. When kindled from above a little fire is lighted at the top of the flue. The kiln is fired always on a still morning before daybreak, whilst its base is open under the lower supports. If the fire has caught properly, first the flue and its contents are burned thoroughly, then the immediately adjoining wood, the fire rising to the top of the kiln. As soon as the dome becomes very hot, steam mingled with thick flocky smoke issues from it. At this period there is always more or less danger of bursting owing to the formation inside the kiln of an explosive mixture of air and combustible gases, or a sudden development of steam. Were such a misfortune to happen, the covering would be blown off and the

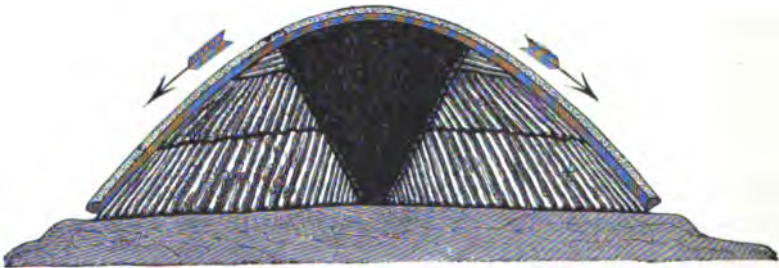

Fig. 313.—Showing progress of carbonisation.

arrangement of the wood disturbed. Too loose a soil under the kiln or too rapid burning may thus imperil matters, the risk of bursting being greater with dry than with slightly green wood.

After a few hours, the smoke acquires a pungent odour, a sign that the wood is being decomposed and that carbonisation is in progress. Charcoal is formed first in the dome of the kiln, proceeding downwards in a wedge (Fig. 313), and the latter sinks down, carrying with it the covering, which should adhere more or less firmly to it. If the carbonisation proceeds properly, a flame should issue from the top of the chimney in the form of a symmetrical cone, widening-out more and more till flames protrude from the base of the kiln.

vii. *Mode of Conducting the Burning.*

The normal process of carbonisation just described cannot be secured always uninterruptedly. The draught is sometimes greater in one particular direction and the kiln itself is seldom uniformly built or covered; it may therefore settle down unsymmetrically or burn too quickly or too slowly. Charcoal-burners should know how to secure the kiln against these mishaps, and keep it burning in as normal a manner as possible.

This is effected by the following procedure:—The fire should be led gradually from the top of the kiln to its base, so that the kiln may settle down symmetrically and without burning the charcoal. The space left open at the base of the kiln, that is subsequently closed, may be re-opened if more draught is required, and holes made in the upper part of the covering through which flames protrude, in order to regulate the burning. On the second or third day after kindling, the first holes are made through both coverings down to the wood on the leeward side of the kiln. These are usually in two rows, somewhat below the flame at the top of the kiln. At first the smoke issuing from these holes contains steam, but the nearer the combustion approaches the holes, the clearer, more pungent and pyroligneous it becomes; when it finally turns blue, it denotes that the charcoal is burning. Before the smoke turns blue, therefore, the upper holes must be closed with paste by means of a flat shovel, and a fresh row opened below the lower row. If burning proceeds too rapidly on any side of the kiln, all vent-holes must be stopped, the covering thickened and water applied if necessary.

By means of these simple arrangements, which require the burners' close attention, the wood in the kiln is carbonised gradually. When the carbonisation is nearly over, the fire is at the base of the kiln; holes are then opened there through which at length flames protrude, showing that the burning is completed. The burners must be now on the watch to extinguish the fire at the right moment, and by applying fresh paste or watering the kiln prevent any cracking or bursting of the covering.

During the kindling process, the shaft of the flue, especially in its upper part, burns completely and leaves a hollow space in the kiln. Hollows also may form in other parts of the kiln owing to a defective site, to bad piling, kindling or control of the burning, or to the wood being too damp. If these hollows were not filled, they would cause a draught and attract the fire, the normal course of the burning would be hindered and the yield of charcoal reduced. Owing to the continual increase in size of these hollows, the covering might at length fall in and the kiln burst into flames. All hollows must therefore be filled promptly with short pieces of wood or large pieces of charcoal.

The following method of filling hollows is adopted:—Whenever the burners have noticed that owing to a marked collapse of the covering a hollow has been formed, and have placed the wood or charcoal required to fill it alongside the kiln, they should test the extent of the hollow by tapping the covering with a mallet. They then remove the covering over the hollow, press down the contents with a piece of wood and fill the hollow, covering it again rapidly with branches and paste, and beat the covering into a firm condition. All vent-holes should be stopped at least one hour before filling a hollow and for a whole day afterwards burning should be conducted without any holes in the kiln. The hollow made by the combustion of the chimney is filled on the first evening of the burning and often must be filled again on the second, third, fourth and even on the fifth evening. Often the top-filling is required several times on the same day; in large kilns, as many as 15 to 20 top- and side-fillings may be required during the burning and several more whilst the kiln is cooling.

It is evident that filling hollows in a kiln must waste charcoal, as by opening the covering a draught is caused and the fire unduly stimulated; charcoal is thus burned owing to the flames breaking out, and in pressing down the contents of the kiln some of the charcoal is broken into small pieces. Filling cannot, however, be dispensed with; every endeavour should therefore be made to prevent the sides of the kiln from collapsing, and to reduce a number of indispensable fillings to a minimum.

viii. *Watching and Cooling down the Kiln.*

Every evening during the burning of the kiln the burners should adopt proper measures to secure regularity in the burning. Places where the charcoal is already burnt should be beaten down with a mallet, any fillings which may be required should be effected, cracks which may have opened in the covering should be carefully closed and all holes closed if the weather is stormy. Frequent inspection of the kiln at night is necessary.

Towards the completion of the carbonisation, when the kiln has sunk considerably and the upper covering is very dry and cracked, it should be well beaten down and covered with damp earth, or watered, so as to exclude the air more and more. As soon as the lower covering burns and flames appear at the foot of the kiln, it is clear that the carbonisation is completed; all vent-holes must then be stopped and the whole surface of the kiln covered with damp earth. The kiln is then left alone for about 24 hours. Then in order to hasten the cooling, the burners remove the covering in strips and apply fresh earth to the glowing charcoal so as to fill up all crevices. This extinguishes the fire rapidly, an important point when the weather is dry; about 24 hours, as a rule, after this has been done, the charcoal may be removed.

ix. *Removal of the Charcoal.*

In order that the charcoal may be of good quality, it should not remain longer than is necessary in the glow of the kiln. At the same time it must be removed gradually, so as not to set the kiln in a blaze. A commencement is made in the evening and the work continued all night, when any fire may be seen more readily: each night only a certain quantity of the charcoal is removed, according to the size of the kiln.

The method adopted is as follows:—The burner, with a long-toothed iron fork, opens the kiln on the leeward side and removes as much charcoal as he can without setting the kiln in flames. The charcoal is laid on one side and usually watered, whilst the hole is filled with earth. Then the kiln is opened

at another place and so on all round, until there is nothing left but its centre, consisting of small pieces of charcoal, earth and ashes, which eventually are raked out and allowed to cool.

Once the charcoal has been removed, it is sorted according to size, the small pieces being sifted from the ashes. What is left is mixed with the ashes, etc., and serves for covering the next kiln. The partly carbonised pieces may be kept for filling or kindling other kilns, or carbonised in small kilns made specially for the purpose.

(b) **Alpine* Method of Charcoal-making.**

The method of charcoal-making employed in many parts of the German Alps differs in some respects from the ordinary method. The Alpine kilns are usually in fixed places near river-booms, in timber-depots or at the base of an extensive mountainous tract. The wood thus carbonised is almost exclusively coniferous (chiefly sprucewood and less frequently that of larch and silver-fir) and generally in round pieces 2 meters ($6\frac{1}{2}$ feet) long. The site for the kiln is prepared as in the ordinary method, except that it is quite flat, a wooden base being supplied to the kiln.

The base is formed, as shown in Fig. 314, by placing split billets radially from the flue outwards, on them other pieces are placed sufficiently close together so that all the wood to be carbonised can rest on them, but sufficient intervals are left for a draught of air.

The flue is formed by three stout poles often kept in position by iron rings and is filled, as before, with kindling material. Piling the wood, on account of the size and weight of the pieces, is a heavy piece of work. The kiln is formed of two tiers, and a dome with two thin layers of wood, and is from 5 to 6 meters (16 to 19 feet) high. The wood should be piled as closely as possible, all the larger interstices being filled with split wood. The kilns are usually larger than ordinary ones, but excessively large ones containing 1,500 to 2,000 cubic meters (50,000 to 70,000 cubic feet) are made no longer.

* [Also termed the Italian method, but Gayer states that usually Italians follow the ordinary method with kindling from above.—Tr.]

As the heavy pieces of wood can be piled only with difficulty on the base of the kiln, a kind of a wooden tramway or sledge-road is constructed, on which the pieces can be brought to the kiln in trucks or sledges. As a rule the kindling is effected from above, and for this purpose a central cavity is arranged at the top of the kiln in which the flue terminates. When all the large pieces of wood are piled, the interstices are filled in carefully with small pieces of split wood.

Alpine kilns usually are covered more thickly than common

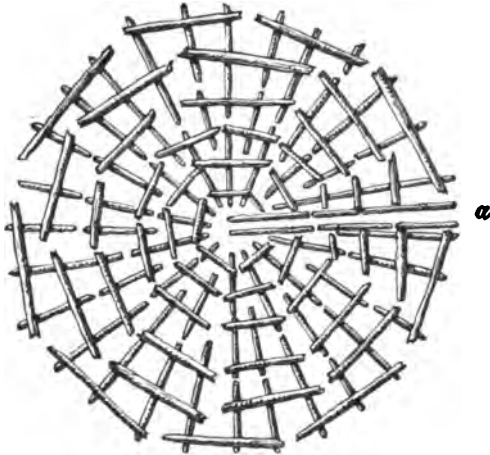

Fig. 314.—Alpine kiln. *a* represents a space left when kindling is applied from below, as in S. Bavaria.

kilns. Ordinary material, if found close at hand, is used for the first covering; usually, however, only a single covering of mixed clay and humus is used, which must be spread very carefully over the wood. Special kinds of props also are used to support the sides of the kiln, which are at gradients of 60 degrees or 70 degrees. These props are formed either as in Fig. 315, of planks (*m*) placed edgewise round the kiln, having niches cut into them at half their length, on which horizontal planks (*n*) rest to support the covering (*dd*), or stout T-shaped props are used as in Fig. 316.

The covering is plastered on to the base of the kiln first, then the lower props are applied and the plastering continued

till the upper props are required; then the dome is completely plastered, though at first only thinly so as to allow the gases to escape.

The kiln is kindled by filling lightly the still open flue with short thin pieces of split wood, on which comes a layer of glowing charcoal. As soon as the kindling material has thoroughly caught fire, fresh charcoal is from time to time heaped on. The split wood which for a time supports the charcoal burns completely, and the glowing charcoal falls to the bottom of the flue. The flue is then filled with charcoal, which is pressed down, and the kindling cavity

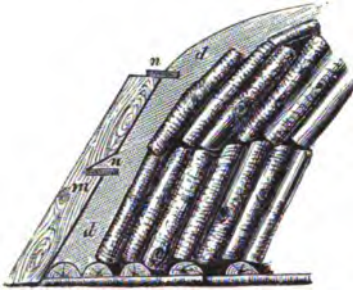

Fig. 315.—Plank-supports of Alpine kiln.

also filled with a heap of charcoal. After a few hours the flue is burned through from below, and must be repeatedly filled, as long as the glowing charcoal continues to sink. When all danger of explosion is over and

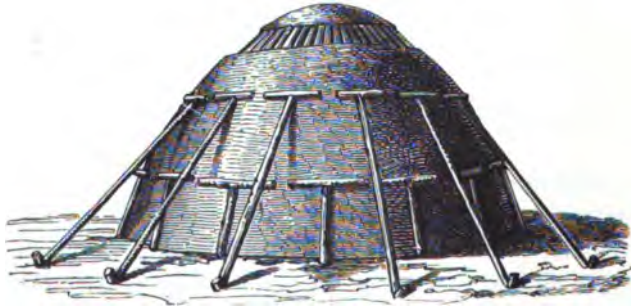

Fig. 316.—Prop supports of Alpine kiln.

the wood in the dome is thoroughly kindled, it is covered with paste, and the burning conducted henceforth as in ordinary kilns.

In Alpine kilns the filling which has just been described must be most carefully conducted; as a rule, only charcoal is used for the purpose.

The Alpine method then differs from the ordinary method of burning kilns in the following points :—

(i) The large dimensions of the pieces of wood to be carbonised and the fact that usually they are not split.

(ii) The wooden base of the kiln to cause a draught of air, which is required owing to the large pieces of usually green wood which are being carbonised.

(iii) The large dimensions of the kilns.

(iv) Only one covering being applied to the kilns, that is usually thick and requires special supports.

(v) By the special mode of kindling, which is usually, though not always, from above.

2. *Kilns with Wood piled Horizontally.*

In Sweden and Austria, wood to be carbonised is piled horizontally, but the practice is becoming less frequent than was formerly the case. The following are the chief points of difference between this and the ordinary method.

(i) The wood carbonised is chiefly coniferous ; the pieces are round logs, barked if possible, and of various dimensions up to 20 feet or (in Sweden) 26 feet in length. The pieces of wood must be quite straight, or they could not be piled densely. As such large pieces may be used for timber, the method is employed only in localities where the timber of the species in question is unsaleable.

(ii) The site chosen for the kiln is usually on slightly inclined ground, but otherwise of a nature similar to that described for ordinary kilns. It is also prepared similarly, but often is merely levelled, covered with earth and firmly beaten down.

The size of the kiln also should be considered, its breadth being the length of the pieces of wood and its length varying (usually 13 to 20 feet, but often 25 to 40 feet, and even, according to v. Berg, 60 feet). The site should be a long rectangle, the longer side of which has a slight gradient.

(iii) In piling the wood, the first point is to make the base of the kiln ; it consists of three long straight poles which are placed on the ground at equal intervals, lengthways as regards

the kilns (Fig. 317, *m m*). At the lower end of the kiln stout stakes are driven into the ground (Figs. 317, 318, *p p*), and the piling commences against these stakes. As in the figures, the thickest wood is placed in the middle of the kiln and near

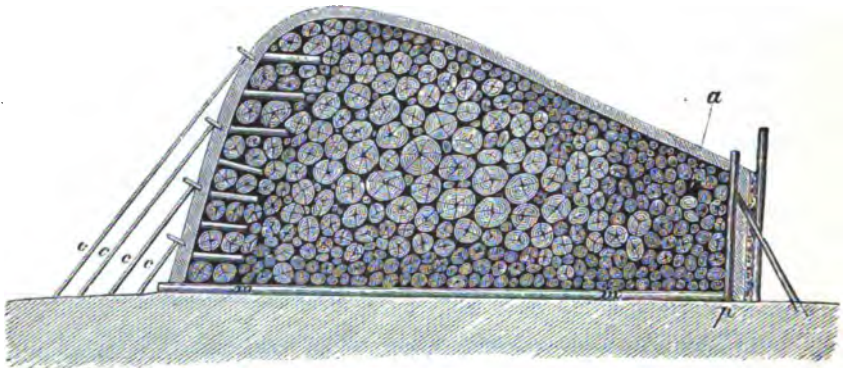

Fig. 317.—Horizontal kiln.

its upper extremity, while the smaller pieces are placed above, below and at its foot.

The wood should, in this case also, be piled as closely as possible, and interstices filled in with split wood. The flue is

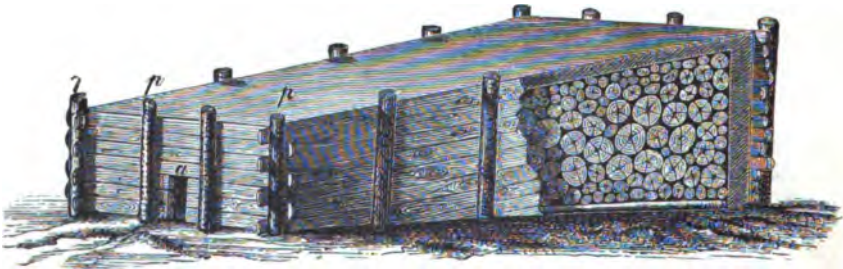

Fig. 318.—Horizontal kiln.

formed, as may be seen from Fig. 317, *a*, by placing several logs around a cylindrical hole running from side to side of the kiln, or as in Fig. 318, *a*, a kindling chamber is left open, as is customary in Steiermark.

(iv) The kiln is now covered; the inner covering is usually spruce or silver-fir twigs, the lower ends of which are stuck into

the wood so that they overlap one another like tiles. The outer covering consists of a paste similar to that used in ordinary kilns, or the same mixed with damp earth.

In order that this paste may adhere to the vertical walls of the kiln, the latter are supported by poles placed 6 to 8 inches apart along the two sides of the kiln, and its front (Fig. 319), or in Steiermark the whole kiln, is surrounded by planks (Fig. 318) resting on horizontal logs (*n n n*, Fig. 319), to secure a draught of air. The paste is applied between these planks and the ends of the logs, and is rammed down. The back of the kiln is, in Sweden, supported by props (*c c c*, Fig. 317). The roof is

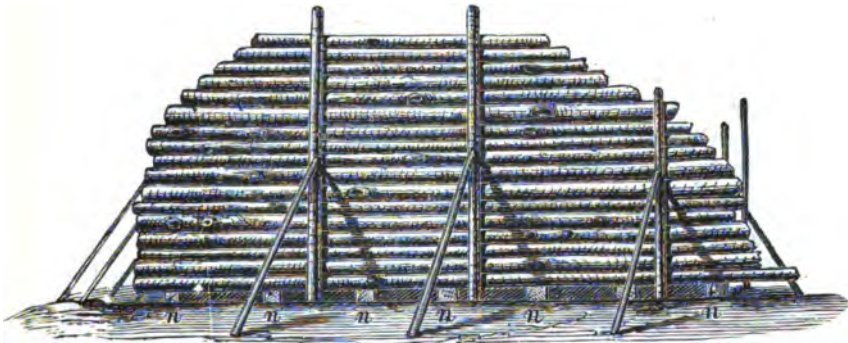

Fig. 319.—Back wall of a horizontal kiln.

at first only thin, and is thickened after the kiln has been fired, when there is no longer any danger of its bursting.

(v) In order to fire the kiln, the kindling flue, or chamber, is filled with readily combustible material, the filling being continued with an open flue until the kiln is thoroughly alight. The whole front portion of the kiln must burn if the fire is to continue uniformly throughout. Once this has been secured the kindling flue, or chamber, may be closed, and the combustion continued by opening successive vent-holes in the roof (in Steiermark also in the sides of the kiln), as in the ordinary method.

Carbonisation proceeds obliquely backwards, the fire being always more advanced towards the roof than at the base of the kiln. Thus the base of the back of the kiln is the last to be carbonised, and the process is completed as soon as flames emerge from ventholes there. The charcoal is cooled by

removing part of the roof and putting earth on it, the walls not being opened.

(vi) The charcoal is removed first from the front of the kiln. A portion is removed daily, and the kiln closed again.

In Steiermark, a commencement is made by removing the charcoal whilst the back of the kiln is still burning. As the front part of the kiln burns longest and the charcoal there becomes light, attempts are made to prevent this by its early removal. It should, however, be remembered that this frequent opening increases the draught, and must cause a considerable loss of charcoal.

3. *Pit-kilns.*

Charcoal-making in pits is the roughest and least productive method. A round pit with sloping sides is dug in ground sufficiently firm for the purpose, to a depth of about a meter, and is filled with dry brushwood. This is kindled and remains burning openly until the smoke ceases and the glowing embers remain; these are then pressed together, the wood being placed in the pit and left to burn till the smoke has ceased. Fresh wood is then thrown in at repeated intervals until the pit is full. Then the pit is covered with sods and earth, and the charcoal allowed time to cool; the pit can be opened in 1 to 2 days for removal of the charcoal. Such a method is justifiable only when wood has hardly any value, as **almost free admission of air** is involved. If the pit is dug on a little hill or on a gentle mountain-slope so that a channel from it leads out to the lowest part of the ground, the liquid products of distillation (**tar**) can be secured. Similarly tar may be collected from ordinary kilns if pits are dug below the kiln, as in Russia. Kilns may be surrounded also by masonry, as in lime-kilns, so that both charcoal and tar may be obtained.

4. *Yield of Charcoal.*

In discussing the quantity of charcoal which a certain volume of wood may be made to yield, the following points should be considered:—**the kind of wood, situation of kiln, state of weather, process and duration of burning, and different methods of carbonisation.**

(a) **Kind of wood.**—All wood being converted into charcoal naturally shrinks. Dry wood shrinks less than green wood, and consequently gives a larger return. Large pieces of wood also yield in volume more charcoal than small pieces, as more of the former can be piled in a kiln.

(b) **Situation of kiln.**—The nature of the site of a kiln has an important effect on the yield of charcoal, a new site yielding less than one repeatedly used.

(c) **State of the weather.**—The weather has important effects on the yield of a kiln. Uniformly still weather, which occurs frequently in late summer and autumn, is best; changeable weather, accompanied by storms, is most unfavourable.

(d) **Process of burning.**—Slow, careful progress, especially during the earlier part of the burning, not only yields heavier charcoal, but also a larger volume of it.

(e) **Duration of the burning.**—The length of time during which a kiln should burn is very variable and depends on its size, on the dimensions and degree of dryness of the billets, the quicker or slower action of the fire (according to the site, arrangement of the wood, weather, etc.) and many other circumstances. Small kilns of sprucewood containing 700 to 1,000 stacked cubic feet are carbonised in 6 to 8 days, beechwood in somewhat less time. Large kilns containing 3,500 to 7,000 cubic feet, in favourable weather, require about 4 weeks to burn, and in unfavourable weather, 5 to 6 weeks.

(f) **Methods of carbonisation.**—It is difficult in practice to decide which method gives the best outturn, as there are so many intervening facts. It appears, however, that the common method, with kindling from below, gives the best results. The comparative outturn of charcoal in quantity and quality depends greatly on the skill and foresight of the burners, which is really the most important of all factors, as experience shows in the case of permanent sites of kilns where the burners are frequently changed.

(g) **General results.**—Charcoal may be measured by weight or volume, the latter being more frequent and large baskets or rectangular measures being used for the purpose.

Coniferous wood yields more charcoal than broadleaved species; soft, broadleaved woods less than coniferous wood,

but more than hardwood. Branchwood and wood in the round yield less than split wood. Thus the yield of charcoal is inversely proportional to the sp. weight of the wood, as heavy wood shrinks more than light wood. The yield by weight is directly proportional to the sp. weight of the wood.

The average yield from forest kilns may be considered good for broadleaved wood with 50%, and for coniferous wood 60%, by volume. The yield by weight is about 25% for all wood.

Von Berg,* from average conditions of all intervening factors and after comparing large quantities of wood, gives the following percentages:—

| Species of Wood. | Volume. | Weight. |
|-------------------------------------|---------|---------|
| Beech or oak (split billets) | 52—56 | 20—22 |
| Birch " " | 65—68 | 20—21 |
| Scots pine " " | 60—64 | 22—25 |
| Spruce " " | 65—75 | 23—26 |
| " (stump-wood) | 50—65 | 21—25 |
| " (round billets) | 42—50 | 20—24 |
| " (small branchwood) | 38—48 | 19—22 |

Beschoven † gives the following results of his researches in Eisleben, in percentages:—

| Species. | Volume. | Weight. |
|-------------------|---------|---------|
| Oak | 71·8 | 21·3 |
| Beech | 73 | 22·7 |
| Hornbeam | 57·2 | 20·6 |
| Birch | 68·5 | 20·9 |
| Scots pine | 63·6 | 25 |

5. Assortment.

Charcoal is classified as soon as it is taken from the kiln, according to the species of wood of which it is made, and also according to the size of the pieces. The smaller pieces

* "Anleitung zum Verkohlen des Holzes."

† Grathe, "Brennmaterialien."

are sifted from the refuse dust and sold separately, while pieces that are not sufficiently charred are set aside for a fresh kiln, or are charred again at once in small kilns.

6. *Properties of Charcoal.*

Good charcoal has a heating power of 7,000 to 8,000 calories, approaching that of pure carbon. Its composition is as follows:—

| | |
|-----------------------------|-----------|
| Carbon | 75—80 % |
| Hydrogen | 1·5—2·5 „ |
| Oxygen | 8—12 „ |
| Hydroscopic water | 6—12 „ |
| Ashes | 1—2·5 „ |

Violette has shown that the quantity of carbon in charcoal is lower, the greater the heat of combustion. Charcoal has a higher heating-power, the heavier it is and the heavier the wood from which it is made; while the higher the temperature at which it is burned the lower is its sp. weight. Violette therefore assigned to charcoal of elder-wood:—

| | |
|-----------------------------|-----|
| At 350° a sp. weight of 150 | |
| „ 1,025° „ „ | 184 |
| „ 1,500° „ „ | 187 |

On the average the sp. weight of charcoal varies from 140 to 200, that of water being 100.

The sp. weight of charcoal in pieces, with numerous air interstices, according to Hassenfratz is:—

| | |
|-------------------|------|
| Birch | 20·3 |
| Ash | 20·0 |
| Beech | 18·7 |
| Hornbeam. | 18·3 |
| Elm | 18·0 |
| Spruce | 17·6 |
| Oak | 15·5 |

According to Mayr's researches, the sp. weight of the best

Japanese charcoal (*Quercus serrata*) is 82.9; of beech charcoal, 38.5; spruce, 31.5; boxwood, 81.7. Hassenfratz's figures are too low. Good charcoal should be bluish black, with an oily lustre; it should not split, but have a conchoidal fracture, should have a metallic ring when struck, and exhibit clearly the structure of the wood. It should be hard and without taste or colour, burn with a short, blue flame, without smoke or odour, without crackling or emitting sparks. Good charcoal is highly absorptive of gases; beech charcoal absorbs 35 times its volume of CO₂, 90 times its volume of ammonia. Charcoal is antiseptic, it prevents a mouldy scent and hinders decomposition; it has an immense durability.

SECTION III.—THE COMBUSTION OF WOOD.

As regards the utilisation of the combustion of wood for heating purposes, this is dealt with in the next chapter on the industrial uses of wood; here, changes in the substance of wood by combustion in order to obtain useful materials from soot and ashes are considered.

Lampblack is prepared chiefly where there are supplies of resinous conifers used for making turpentine and rosin. The residue after making oil of turpentine and the resinous roots of pines supply the raw material, which is burned with admission of oxygen sufficient to maintain a weak, reddish, smoky flame. The soot is collected from the smoke in chambers covered internally with wool. Lampblack is obtained also from coal-tar.

Ashes, manure-ash and potash were obtained formerly, when wood was without any value, by burning the wood with complete exposure to the air. Such a practice is now confined to remote forests only. But in modern artificial forests there is still much unsaleable material from which ashes may be obtained profitably. Branch-wood and top-and-lop, the almost worthless materials from cleanings and early thinnings, rotten wood and stump-wood attacked by fungi is best burned, so that it may not increase danger to the forest from insects, fungi and fires. The ashes thus obtained are rich in potash, and when mixed with humus supply splendid garden-

manure. Ashes when freed from earth and pieces of charcoal yield the following percentages of potash :—

| | |
|----------------------|------|
| Silver-fir | 39·9 |
| Oak | 33·3 |
| Beech | 28·6 |
| Birch | 23·6 |
| Larch | 23·6 |
| Spruce | 19·7 |
| Scots pine | 14·3 |

By washing the ashes, boiling the solution so as to evaporate the water and heating the residue, potash is obtained.

SECTION IV.—CHEMICAL AGENCIES FOR OBTAINING THE CONSTITUENTS OF WOOD.

(a) **Cellulose.**—Cellulose is employed chiefly for making into paper. Paper-pulp obtained from wood is not only cheaper than that prepared from rags, but gives clearer print and wears away the type less. On the other hand paper that contains much wood-pulp soon becomes brittle and yellowish; hence much of the paper made from wood is useless after about ten years, and it cannot be used for important documents. Unmixed wood-pulp is, therefore, used chiefly for pasteboard, packing paper and the coarser kinds of paper. For superior paper some rag-pulp must be mixed with wood-pulp. Nevertheless, the amount of rag-pulp used depends essentially on the process employed in making wood-pulp, and good wood-cellulose is considered as an alternative for rags.

The wood of **aspen** and **lime** are preferred for paper-pulp, but as they are quite insufficient for the demand for this material, **coniferous wood** is used, chiefly that of **spruce**. Besides these woods those of poplar and birch, and in America those of *Liriodendron* and Weymouth pine, are employed. Poles and logs of 10 to 30 cm. (4 inches to 12 inches) in diameter, prepared as for firewood billets, were usually chosen. At present wood of larger dimensions is employed, as the cost of transport, etc., is considerably less

than for small pieces. The wood should be free from knots and perfectly sound; half dead and dead wood from thinnings is rejected. Peeled round pieces 10 to 30 cm. in diameter and 2 to 4 m. long are stacked in cords for pulp-wood.

The present enormous demand for wood-pulp is one of the chief causes of the clearance of numerous private woodlands, as wood of moderate dimensions is quite suitable. In Saxony 60% of the total timber-supply was used in 1902 for paper-pulp. In North America (1900—3) 200,000 acres of forest were cleared for wood-pulp, in order to supply 210 paper factories. By far the greatest supply of paper-pulp comes now from the extensive coniferous forests of Canada, and is more and more threatening to German trade.

As has been explained on p. 79, the walls of wood-fibres are formed chiefly of cellulose and lignin, with gum, tannin, coniforin, etc. In order to separate the cellulose from these substances, the wood is macerated and the lignin, gums, etc., separated as "incrusting material" from the pure cellulose. Various acids, such as nitric acid and mixtures of nitric and hydrochloric acid are used; but independently of the great cost of these acids—for they can be employed only once—this combination with cellulose is caustic and emits poisonous gases.

The treatment with nitric acid attacks the cellulose and converts it into sugar, which may be neutralised with lime and made into alcohol. At Bex,* in Switzerland, 1 cubic meter (35 cubic feet) of silver-fir wood yields 100 kilos (220 lbs.) of unbleached and 70 kilos of bleached cellulose.

Caustic alkalis also dissolve the incrusting substances and saponify the resin; they have the great advantage of being utilisable several times for maceration. Of these alkalis caustic soda is the most important; it is prepared from soda by the addition of lime.

In preparing cellulose by means of caustic soda, the wood, freed from bark, knots, etc., is cut in an oblique direction to its length into pieces about 2 cm. thick; they are ground into splinters between fluted rollers, working as in a large coffee-grinder, that are 2 cm. long and 5 and 8 mm. thick. These

* Bersch, "Die Verwertung des Holzes auf chemischen Wege," 1893.

splinters are placed in sheet tin perforated vessels that are put into a fixed horizontal boiler. When the boiler is full of these vessels, it is hermetically closed, pumped full of a solution of soda, and boiled under pressure of 10 ats. by means of a fire kindled below it. After 3 to 4 hours the boiler is emptied. The raw cellulose thus obtained is washed, refined, bleached, and pressed successively by several drying rollers, coming out in the form of felt. From 75 to 80% of the solution can be used again. This solution is known in the trade as "soda-cellulose."

More recently this soda process is being abandoned for that of preparing cellulose by means of sulphuric acid, which is brought into contact with the wood splinters in the form of a solution of calcium sulphate. In this method, introduced into Germany by Mitscherlich, the splintered wood is placed in large boilers and steamed, then the solution of calcium sulphate is admitted and boiled with a pressure of $2\frac{1}{2}$ to 5 ats. for 50 to 60 hours. The solution comes from tall towers filled with lime, through which sulphurous acid from burning sulphur passes while water trickles in from above. The solution of calcium sulphate is collected in reservoirs below. The material coming from the boiler is in reddish-yellow soft pieces, that are pounded, washed, passed through sieves, and pressed into felt by rollers.

Cellulose made by both the above processes is used partly for paper-making, partly for wood-pulp (p. 501). There are in Germany 600 cellulose factories using annually $1\frac{1}{2}$ millions of cubic meters of wood.

Kellner's electrical process for preparing cellulose consists in boiling the wood with solutions, chiefly of salt, and at the same time passing an electric current through it. This separates the incrusting material from the cellulose. It cannot be denied that there is now in Germany an over-production of wood-pulp, that is increased by the competition of America and Asia.

The following articles are made of cellulose:—Ornamental relief-work in small pieces for artistic furniture and picture-frames; also entire pieces of furniture, the seats of chairs, casks, buckets, tubs, laboratory and cooking utensils, etc.;

even boats, hollow beams for huts, underground tubes for telephone wires, frames for doors and windows, oars, etc. The spokes of railway-carriage wheels are replaced by fillings with compressed cellulose. Antiseptic wood-cellulose of silver-fir is used for binding wounds. Cellulose is used for floor-cloth and oil-cloth, for packing material specially used for the despatch of gunpowder, and for many other purposes. It is also used for insulating electric conductors, and experiments have been made to prepare gun-cotton from cellulose. Silk is also made from cellulose.

Chardonnel and Lehnert have a patent for converting sulphite-cellulose made of sprucewood into nitro-cellulose by treating it with nitric acid. It then resembles collodion and is drawn through fine glass tubes, which press it into extremely fine threads; 12 to 14 of these threads are spun into a silk thread. The danger of an explosion is avoided by denitrifying the collodion. This artificial silk is even more lustrous than natural silk and can be dyed readily. Most of the cheap silk goods now in the market are made of artificial silk.

A watery solution of cellulose in combination with soda and carbon-bisulphide is named *viscose* and used as a substitute for glue; when this is heated a hard amorphous substance is produced, *viscoid*, which in various colours is used instead of costly celluloid. True celluloid is produced by heating and pressing nitro-cellulose and camphor; this transparent substance is used as a substitute for tortoise-shell, ivory, caoutchouc, etc., or for counterfeiting these substances. Celluloid may be rendered unflammable, and is then called *pegamoid*.

(b) **Sugar and Alcohol.**—As cellulose has the same chemical composition as starch it has been proposed to manufacture from it sugar and alcohol. The wood in small pieces, wood-pulp or sawdust, is acted on by acids and boiled for some time under pressure in order to convert it into sugar and by means of diastase to ferment it into alcohol. Although no successful results are known to have been obtained, it appears as if a great transformation in the manufacture of alcohol will result and that inferior wood-assortments

will thus become valuable. Ydarek* gives the following table:

| 100 Kilos of Wood. | Litres of Alcohol. | Cu. m. | Litres of Alcohol. |
|------------------------|--------------------|--------|--------------------|
| Spruce | 5 to 6·5 | 1 | 50 |
| Silver-fir | 4·5 | — | — |
| Beech | 2·5 | 1 | 40 |
| Pedunculate oak | — | 1 | 47·1 |
| Sessile oak | — | 1 | 50·1 |

Simonsen found that cellulose yields 42·7 per cent., sawdust 22·5 per cent., of sugar. The cellulose in wood is converted into sugar more easily than isolated cellulose; 100 kilos of sawdust yield 6·5 kilos of pure alcohol.

(c) **Oxalic Acid**† is prepared from wood. For this any minute pieces of wood, such as sawdust, is suitable. Owing to the extensive use of oxalic acid in dyes and in calico-printing, its preparation forms an important industry.

The sawdust is mixed with a double solution of caustic lime and caustic soda and is heated up to 240° in shallow vessels. The resulting greenish-yellow mass is mixed in the water in which oxalate of soda remains dissolved until the water is cooled; the salt is precipitated by sulphuric acid in the form of gypsum and oxalic acid.

[(d) **Bamboo-fibre**.—Mr. J. S. Owden states that fine bamboo fibres are prepared in the West Indies, which, spun with wool in the ratio of 1 : 2, yield very strong cloth. Bamboo-fibre is also used as paper-pulp, and for packing the axle-boxes of American railway-carriages.—Tr.]

* "Austrian F. u. Jagdzeitung." 1900.

† Bersch ascribes the success of their industry chiefly to Dr. Thorn.

CHAPTER IX.

INDUSTRIAL USES OF WOOD.

THERE are few raw materials which possess such extensive powers of adaptability and are so largely used for industrial purposes as wood. A casual inspection of the interior of any building is sufficient to convince one of this.

Wood may be classified according to the manner in which it is used, as **timber** and **firewood**. In timber the species and the chemical and physical properties of the wood decide the purpose for which it can be used ; as regards firewood, however, the wood is used only indirectly in order to utilise the heat produced by burning it. The discussion of the properties of wood for the various industries in Chapter I. renders further remarks on them unnecessary here. It is also evident, that in the forestry of the twentieth century not firewood, but timber, must be the chief object of production, for timber unfit for any other purpose may be used for fuel, but mere firewood cannot be used generally as timber.

Subdivision I.—Timber.

SECTION I.—THE DIFFERENT CLASSES OF CONVERTED TIMBER.

1. *General Account.*

The demands on timber are as varied as the kinds of timber available. In considering merely the woods used in the construction of buildings, furniture, implements, tools, and the innumerable articles of convenience, art and comfort, it will be perceived readily that nearly every object requires a special kind of wood. If, therefore, a forest is to be worked intensively, so as to yield the highest possible revenue, it should produce wood which may be used to the greatest advantage, or, in other words, which is most valuable. In order that the produce of a forest may be of this nature, the forester should

possess a thorough knowledge of the special requirements of industries using wood, which is too much to expect from him. To a certain extent, however, this knowledge is indispensable, especially as regards those industries which obtain their wood directly from the forest, and require it in large quantities.

It is true that iron competes more and more with wood for certain purposes—as for shipbuilding, agricultural implements, water-pipes, telegraph-posts and railway-sleepers, where it has been substituted largely for wood; in mines, iron rails and props are used; in the construction of large bridges, woodwork is entirely dispensed with, and iron instead of wooden pillars are used where vertical support is required to a building. Even in numerous small articles iron has been substituted for wood. Yet with the constant increase in human requirements, hundreds of new uses for wood are found, and therefore the demands for high-class timber increase constantly whilst the area of the forests decreases, so that the supply of this valuable material tends to diminish.*

The timber required for various industrial purposes does not in many cases pass directly from the woodman to the artisan, but generally through the intervention of a middleman, the timber-merchant, who converts rough timber into pieces of dimensions suitable for the requirements of the various industries. In this intermediate state it is termed converted or marketable timber.

Timber may be classified according to its form, adaptability, and mode of conversion, and this classification naturally precedes the account of the different wood-industries. Thus, logs may be distinguished from sawn, or cloven timber.

2. Logs.

Logs are pieces of timber which retain the full thickness of the stem, but may be more or less shortened. They are

* [A paper was written in the "Revue des Eaux et Forêts," December, 1894, showing that in Britain, whilst the production of iron is as great as in all the rest of Europe, yet the imports of timber have risen, between 1860 and 1890, by 168 per cent. As regards the timber-supply from forests in the United States, R. S. Kellogg, "The Drain upon the Forests," U.S. Dep. of Agri., November 30, 1907, says that it is probably three times the annual increment.—Tr.]

distinguished further as **round logs**, and **balks** which have been **squared**, or are of rough prismatic shape and are then termed **sided timber**.

(a) Thus, **timber in the round** is the part of a stem which has been merely barked, and may be used directly as piles, masts and spars, wheel-hubs, scaffolding-poles, pillars, anvil-stocks, telegraph-posts, hop-poles, or, when bored, for water-pipes.

(b) **Balks** are used as beams in the construction of houses, bridges or ships, being logs squared roughly either with the axe or saw. If not quite square they are termed **waney** (Fig. 320, *o, p, q, r, s, t, u, v*), **wanes** being the natural surface

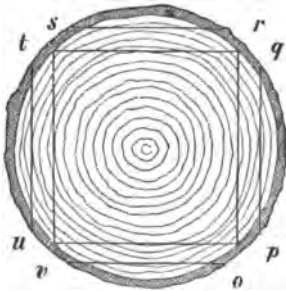

Fig. 320.—Log with bark, barks without bark.

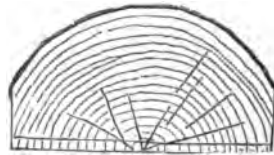

Fig. 321.—Half-balk.

of the timber, and **panes** the flat, hewn or sawn surfaces from which **side-pieces** have been removed. In the case of **waney barks**, for which rarely more than two-thirds of the trunk are utilised, the waste is about 12 to 15 per cent. of the whole, while, when the timber is square, the loss is about 27 per cent.

Boles about 60 feet long and of about $8\frac{1}{2}$ inches mid-diameter, corresponding to 12 inches diameter chest-high ($4\frac{1}{2}$ feet from the ground), are commonly used for barks.

(c) **Round oakwood** is sometimes split through the centre into **half-barks**, with a section as shown in Fig. 321. These half-barks are met with in the Baltic oak-trade, and in the case of oak from the Spessart, they are used in cabinet-making and joiners' work.

Quarter-balks (*bois de quartier*) are produced commonly in France by sawing two cuts at right angles to one another through the heart of a tree.

3. Sawn Timber.

[Various methods of sawing timber are shown in Figs. 322 to 325, the best sawn pieces being obtained by cutting as much

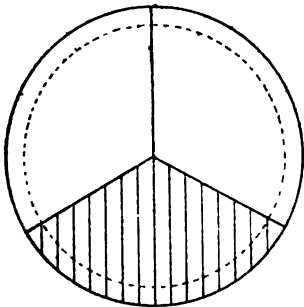

Fig. 322.

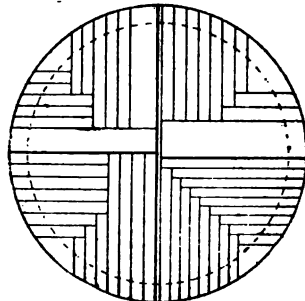

Fig. 323.

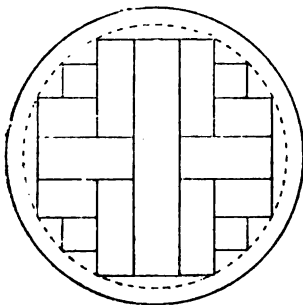

Fig. 324.

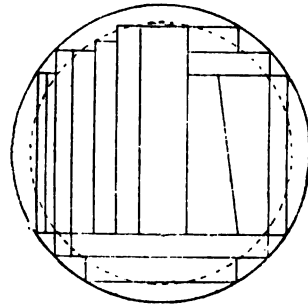

Fig. 325.

Methods of sawing, after Boppe.

as possible in the direction of the medullary rays, as wood has a better appearance (silver-grain), and stands friction better in this way.—Tr.]

Scantling, battens and planking, comprise the different forms of timber after the stem has received several saw-cuts lengthwise. Naturally, in these forms of converted timber the full diameter of the stem is no longer retained, except sometimes in one direction, and the length of the pieces is

generally of greater importance than their breadth; it is chiefly large trees (16 inches and more in mid-diameter) which are most usually converted into planks and scantling, and the following kinds are commonly known in the timber-trade:—

(a) **Pieces square, or nearly so, in Section.** (Fig. 326.)

i. **Scantlings** may be 8 to 20 feet long, and in section 2 inches by 2 inches, $2\frac{1}{2}$ inches by $2\frac{1}{2}$ inches, 3 inches by 3 inches, 3 inches by 4 inches, 3 inches by 5 inches, 4 inches by 4 inches, 4 inches by 5 inches, 5 inches by 5 inches, and $5\frac{1}{2}$ inches by 6 inches; they are sawn from



Fig. 326.—Scantlings.

logs and beams, of 2 to 6 inches mid-diameter and 8 to 20 feet long, also from planks. They are used for supporting floors and roofs, for door-posts, gates, etc.

ii. **Laths** are made by sawing up planks, and are generally less than 2 inches thick, from 10 to 20 feet long, their usual dimensions are $\frac{3}{4}$ inch to $1\frac{1}{4}$ inches thick, and $1\frac{1}{2}$ inches to 2 inches wide. They are used in supporting tiles, slates and ceilings, also espaliers, vines, etc.; they are frequently split instead of being sawn. Laths for ceilings may be sold even when $\frac{1}{3}$ rd of an inch thick and 1 foot or 2 feet long.

(b) **Boards in which the Breadth is much Greater than the Thickness.**

i. **Planks** are cut right through the stem and are usually 10 to 20 feet in length, and 8 to 14 inches by 2 to 4 inches, and exceptionally 6 inches in section.



(Fig. 327.)



Fig. 327.—Boards.

[In the case of oakwood such planks take at least one year for every inch of thickness for seasoning, and they are kept in stock by timber-merchants

and used for all kinds of purposes, frequently after being further reduced in size. Railway-sleepers are comprised under this class, their dimensions will be given further on.—Tr.]

ii. **Deals** under 2 inches in thickness, usually varying from $\frac{1}{2}$ inch to 1 inch, and of various lengths, but generally from

10 to 20 feet long, and $5\frac{1}{2}$ inches to 1 foot broad, the usual breadth being 8 inches to $1\frac{1}{4}$ feet. They are used for floors, door-panels, cabinet-making, etc.

iii. **Battens**, or small boards, may be 8 feet to 20 feet long, and in section 4 inches by $\frac{3}{4}$ -inch, up to 7 inches by 3 inches. They are used for door- and window-frames, etc.

4. *Cloven Timber.*

Cloven timber comprises all those sorts of timber in which the wood is split, or cloven, along the direction of the fibres; it comprises staves for casks, park-palings, laths, shingles for roofing, spokes for wheels, rungs for ladders, hurdle-wood, etc. This class of wood is characterised by the fact, that the fibres not being severed, the wood preserves its **natural elasticity and strength** and is much less permeable by liquids; it is less liable to warp and crack than sawn timber. The work of cleaving timber is also more expeditious and requires simpler implements than sawing, and there is scarcely any waste of material involved. In cleaving wood it is advisable, whenever possible, to work from the centre of the piece of wood outwards.

SECTION II.—TIMBER USED IN SUPERSTRUCTURES.*

(a) **Different Kinds of Superstructure.**—The term **superstructure** includes all parts of buildings that are above ground or water, so that the timber used in their construction may be exposed to the external air and to atmospheric influences, but not to moisture from the soil or in water-courses. Building-timber may be distinguished as **sawn timber** (beams, planks and scantling), which is fitted by a **carpenter**, and **planed timber** used for floors, doors and windows, and fitted by a **joiner**.

According to the demands on the durability, strength, beauty, etc., of the timber used, and to its local value, different modes of building are employed, some of which use timber in large quantities, and others much more sparingly.

* M. Lizius, "Handbuch der forstl. Baukunde," Berlin, 1896.

These modes of building may be distinguished by the nature of the walls erected. Thus, **block-houses**, or **log-huts**, have entirely wooden walls; the **wooden frame-work** sometimes employed for the walls of houses may be filled in with planks, bricks, or lath and plaster; the walls of other perstructures are built of mud, stone, or **brick masonry**.

In the case of **log-huts**, the walls of the whole building are made of round logs or squared balks, the necessary firmness of the building being secured by dovetailing their ends into beams placed at right angles to them. **Log-huts** are still used in the Alps, and in countries like America or Australia, where timber is still abundant.

A higher class of houses is built with a complete wooden framework of beams and scantling, dovetailed and riveted together, and the interspaces are covered afterwards with planks, or filled-in with lath and plaster, or with rubble- or brick-masonry. Houses with a wooden framework filled-in with masonry are termed **half-timbered**. In the Middle Ages, owing to the abundance of wood nearly all houses and even large edifices were built with a wooden framework; at present, this mode of construction is limited to woodland districts and especially to Switzerland and the Black Forest. Its use is becoming more restricted in Europe as communications improve and it is being replaced by stone- or brick-masonry.

[In countries like Japan or Assam, where earthquakes are frequent, this mode of building with wooden framework is far safer than masonry, the interspaces between the wood being filled-in with reeds or bamboos and plastered over. In the event of an earthquake, the whole house holds together and the danger of falling masonry is avoided. Frequently owing to the malarious nature of the country in Assam, houses are raised above the ground on piles.—Tr.]

Brick- or stone-masonry is the best material for the walls of buildings, and at present is most common [though in fairly dry countries, such as the N.W. of India, walls and even roofs are made frequently of mud.—Tr.] In all these cases the minimum amount of wood is used, and chiefly for

doors and window-frames, for the flooring and wainscoting of the different stories (though even these may be made partly of stone and cement, supported by steel girders), and for stair-cases and roofing.

Wooden scaffolding used during the construction of buildings of all kinds also requires a large quantity of round timber and some planking; work-sheds and other similar constructions are made usually with a wooden framework.

Beams, scantling, planks, etc., and round timber for scaffolding, are the usual forms in which wood is used in superstructures, while the properties which timber should possess for use in superstructures may be considered under the headings—**shape and dimensions, strength, durability and weight.**

(b) **Shape and Dimensions of Timber Used.**—Although in the construction of staircases and of half-timbered houses, curved wood is not excluded, the carpenter requires **straight, cylindrical logs** for most of his pieces. The length and diameter of the pieces depend, of course, on the size of the building for which they are required, but the pieces used for any particular building are classed in uniform sizes. They are seldom thinner at centre than 4 to 6 inches, or thicker than 1 to $1\frac{1}{2}$ feet.

(c) **Strength of Material.**—Timber is subjected to loads which when applied transversely to the length of the pieces tend to cross-break them. In such cases, the timber serves the purpose of a beam, as for instance, the joists for supporting floors and rafters for roofs.

The strength to resist bending is proportional to the width of the beam and the square of its depth. Two beams of half width have the same strength as one of whole width, but two beams of half depth superposed one on the other have only half the strength of one of whole depth. The greater transverse thickness therefore should be placed in the direction in which the load is applied. In order to provide sufficient stiffness as well as strength, the depth of beams, etc., is made from $\frac{1}{2}$ th (in short beams) to $\frac{1}{20}$ th of the length or span (in beams 20 feet long), and to give lateral stiffness, the width is about $\frac{1}{3}$ rd of the depth in short beams, and $\frac{1}{4}$ th in

long beams. For spans exceeding 20 feet, iron and steel girders are generally used.

When the load is applied in the direction of the length of the piece of timber, the latter acts as a strut or column, when the load thrusts, or as a tie when the load pulls. Timber is exposed very rarely to a strong pull on account of the difficulty of getting secure attachments to the ends of a piece; by merely butting the ends, however, unlimited thrust may be applied. Long struts or columns are liable to yield not by direct crushing, but by cross-breaking due to lateral bending. The thrust which can be borne safely varies from $\frac{1}{4}$ of a ton per square inch of section in struts of a length equal to 8 times their diameter, to one half of that amount when the length is 24 times the diameter.

(d) **Degree of Soundness and Durability.**—All pieces of timber used in constructions must be perfectly sound and sufficiently durable, and in all cases none but thoroughly seasoned timber should be used. Some of the pieces used in buildings are exposed to decay more than others, such as those used for cellars, wash-houses, breweries, stables and other damp places, whilst roofing timber is less endangered.

It is not surprising to find, if green timber be used, that destructive fungi attack the beams, etc., and early repairs are necessitated. Pieces of wood that are most exposed to decay, and nowadays the ends of all beams, are smeared or impregnated with antiseptic substances, such as carbolineum, antimonium, tar, etc.

[In countries where white ants abound, only wood which they do not attack should be used in constructions, an exception being made for rafters, when the masonry, or half-timbered walls are secure against the passage of the ants. It is also usual to smear the timber externally with wood-oil, extracted from species of *Dipterocarpus*, which is a great preservative against insects.—Tr.]

(e) **Weight.**—Weight is avoided as much as possible, especially in the roofs of buildings, which were formerly made of heavy oakwood. In substituting light coniferous wood instead of oakwood for roofs, fairly durable wood should be

used, such as narrow-zoned and not broad-zoned wood—at least, for the principal roof-timbers. Usually the price of this fine-zoned timber is considerably higher than for inferior material. Greater ease in construction is also a cause of the preference of light to heavy wood.

[In India, bamboos are used largely for roofing; under thatch they should be at least three years old shoots, and thoroughly soaked in water for a month or two before being used, in order to avoid insect-attacks.—Tr.]

In Europe, chiefly the woods of **spruce**, **larch**, **silver-fir**, and **Scots pine**, are used in buildings on account of their lightness and other qualities, good larchwood being the best material of them all. These woods are straight and strong, and if not grown too quickly, sufficiently durable; they are cheap and easily worked. **Oakwood**, formerly considered indispensable for building purposes, at present is used much less frequently, on account of its high price. Still it should be preferred in all damp, steamy places, where great demands are made on the durability of a wood.

The **spruce** is used more extensively in buildings than any other timber, on account of its cheapness and special qualities. Its perfectly straight stem possesses great transverse strength and sufficient durability, its wood also is light and easily worked. Owing to its greater durability, good **larchwood**, which possesses all the other qualities of the spruce, is used largely in mountain districts. **Black pinewood** from the Alps approaches larchwood in value. The **Scots pine** also affords excellent building-timber, which is more durable than sprucewood, and is preferred generally for beams. **Silver-firwood** is very elastic, and yields timber of as large dimensions as any of the above; it is more cylindrical than sprucewood, on which account it is preferred to it in some districts. In others, it is reported as of limited durability, and liable to be worm-eaten; but usually is preferred to sprucewood in damp places. It appears doubtful whether builders really distinguish between spruce and silver-fir timber; local custom frequently prescribes the kind of building-timber which is preferred, irrespective of its other good qualities. Silver-firwood grown in Britain is in higher repute

than indigenous sprucewood. Wood of the Weymouth-pine also is used in buildings; it was considered to possess little durability or strength, so long as only young wood without heart was used. Weymouth pinewood indeed is the lightest of the important coniferous woods, but it is not correct to say that it is the worst. F. Roth ("The Wood of the White Pine," 1899) says that in the United States, and perhaps throughout the world, no wood is used for so many purposes as Weymouth pinewood.

The wood of few broadleaved species, except the oak, are used in buildings. [Chestnutwood has been reported to have been used in roofing cathedrals in France and England, but Mathieu (*Flore forestière*) states that when the wood of these roofs has been examined by an expert, it has been found always to be of oak.—Tr.] Elmwood and wood of robinia afford good building material, but are scarce in Germany, though the former is fairly common in Britain. Aspenwood, in spite of its little durability, is sometimes used for light roofing spars. Almost any wood may be used to fill in the frame-work of timbered houses; often beech is employed for this purpose.

Amongst foreign woods, that of the Pitch pine (*Pinus palustris*), on account of its great durability, strength, beauty of grain and comparative cheapness, is in great demand.

In the selection of various woods for building purposes, the price and facility for working are usually decisive, also custom and sometimes prejudice.

In the east of North America, for centuries, the most important building-timber has been that of Weymouth-pine; as now the supply of this timber is nearly exhausted, swamp-cypress (*Taxodium distichum*) and other timbers that were formerly despised, especially that of species of pine, have come into use. *Quercus alba* replaces our oaks; in the west and south of North America, redwood (*Sequoia sempervirens*), in the north, *Pinus ponderosa* and Douglas fir, are the most important timbers. [Western larchwood (*Larix occidentalis*) also from Montana is coming into use.—Tr.] In Japan, *Criptomeria japonica* is most used; wherever this fails, pines and cypresses are selected. The Imperial palace is built of the wood

of *Chamæcyparis obtusa*; only Zelkova Keaki is used for temples.

[In India, teak, deodar, *Pinus excelsa* and sál (*Shorea robusta*) yield the best building timber, but each province (especially the moister regions of Bengal, Assam, Burma, Bombay and Madras) possesses a few other species yielding durable timber. By far the larger number of Indian trees are devoured by the white ant, however well they may be seasoned; this restricts greatly the possible selection of timbers to be used for buildings.—Tr.]

SECTION III.—TIMBER USED ON, OR IN, THE GROUND.

Woods used in the form of piles for foundations in swampy ground, or to support road-embankments; also woods used in aqueducts, roads, railways or mines, come under this head.

1. *Wood used in Foundations of Buildings.*

Where buildings are constructed on yielding soil, frequently a foundation is made for them by driving piles 8 inches to 12 inches in diameter, and 10 feet to 16 feet long, into the ground, sometimes in several tiers one above the other, until a firm foundation has been secured. Frequently this takes a very large quantity of timber. Wherever these piles are not completely under water they are extremely liable to rot owing to the variable moisture in the soil, which is not usually sufficient to exclude the air, and to the usually moderate temperature of the soil. Hence the most durable woods are used for this purpose, such as oak and resinous conifers, chiefly larch and Scots pine. Wherever the soil is permanently wet, alderwood also may be used, as it is essential that the piles should be straight.

2. *Wooden Water-pipes.*

Although everywhere iron water-pipes are replacing wooden pipes for aqueducts, yet in certain well-wooded countries the latter are used still; for this purpose the best Scots pine-wood, larchwood and black pinewood are most suitable. Only straight pieces are used, as in boring them the auger must not leave the heartwood nor penetrate the sapwood, which has

no durability. Pines suitable for water-pipes are free from knots, with fine bark and small crowns. Trees 10 inches to 16 inches in diameter, chest high, are the best. As larch has very little sapwood any straight tree of sufficient size will serve the purpose. Usually these woods last 8 years to 10 years if they are laid at a proper depth below the surface of the soil, somewhat over 2 feet, where frost and heat do not affect them.

Failing these, woods of spruce, silver-fir and alder may be used. Oakwood gives the water a bad taste, it is too expensive for the purpose, and other woods are not sufficiently durable. [Deodar-wood is the best to use for aqueducts in the Himalayas.—Tr.] The wood is bored and used quite green, and supplies of wooden pipes must be kept in running water to prevent warping and cracking. It is preferable to keep them in dry sheds than in stagnant water, where spores of fungi get into the tubes and cause premature decay.

Single pipes are 10 feet to 13 feet long, as it is difficult to bore them to a greater length. The wall is generally as thick as the bore.

3. *Wood used for Timber Export-Works.*

Wood is used frequently in forest export-roads, slides, or sledge-roads. Wherever there are extensive coniferous forests, and the local prices of wood are low, large quantities of wood are used for fencing, supporting embankments, culverts, bridges, and for covering swampy ground; all kinds of wood, chiefly coniferous wood, are used.

4. *Wood-Paving.**

Wood-paving is now employed in the streets of large cities. [In London, jarrah (*Eucalyptus marginata*) and kari (*E. diversicolor*) are used largely for this purpose, and doubtless Pyngado (*Xylia dolabriformis*), and other heavy Indian woods might be used with advantage.—Tr.] Among European species the hardwoods, beech, oak and elm are best, but owing

* C. L. Hill, "Wood-paving in the United States," U.S. Dep. of Agri., March 4, 1908.

to its cheapness Scots pinewood is also used and has proved to be as durable for this purpose as Pitch pine.

Generally injected wood is used, zinc-chloride is said to have given better results in this respect than creosote. The wood is used either in rhombs, or rectangular prisms, placed on a slightly arched layer of concrete, molten asphalt being poured between the blocks, which are afterwards covered with a layer of fine gravel and well rolled.

The blocks of wood are 6 inches to 12 inches long, 3 inches

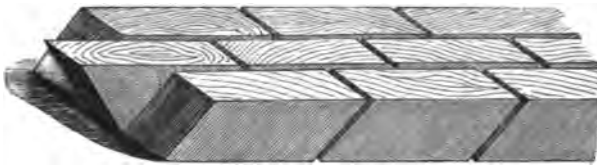

Fig. 328.—Rhombic street-paving.

broad, and 6 inches to 7 inches thick ; when rectangular they are placed endways, and when rhombic, as in the figure. Experience in London and other large cities gives the following results.

| Qualification. | I. | II. | III. |
|----------------------------------|---------|---------|---------|
| Cleanliness and hygiene | Asphalt | Granite | Wood |
| Scarcity of dust | Wood | Asphalt | Granite |
| Duration | Granite | Asphalt | Wood |
| Safety of traffic | Granite | Wood | Asphalt |
| Cheapness of construction | Wood | Asphalt | Granite |
| " " repairs | Granite | Asphalt | Wood |
| " " maintenance | Granite | Asphalt | Wood |

[There are also some important points to be considered, especially noise from traffic and wear-and-tear of tyres; in these respects wood and asphalt are evidently superior to granite or other hard stone. As regards the various kinds of wood, softwood wears away evenly and does not impair the concrete beneath it. Hardwood wears less rapidly, but unevenly, and injures the concrete below, so that it must be taken up when fresh wooden blocks are laid. Non-absorbent wood is the most hygienic, as much horse-urine permeates absorbent wood.—Tr.]

Blocks of Scots (red) pine and other wood are used also for the flooring of stables, threshing-floors, or outdoor staircases.

5. *Railway-Sleepers.*

Up to the present time railways have made great demands on forests, chiefly for **railway-sleepers**, or ties, as they are termed in America.

[The dimensions of railway-sleepers vary in different countries, in England being 9 feet by 10 inches by 5 inches, or $3\frac{1}{2}$ cubic feet; eleven of these sleepers are used for 30 feet of line, being about $2\frac{1}{2}$ feet apart, but are further apart towards the centre of the rails and closer near the joints. Each red-pine sleeper is saturated with $2\frac{1}{2}$ gallons of creosote, which is forced into the sleepers under pressure. The breadth of gauge between the rails is 4 feet $8\frac{1}{2}$ inches, which with the width of the rails, $3\frac{1}{2}$ inches, makes up 5 feet, the ordinary width apart of the wheels of a cart. In France great latitude is allowed in specifications of sleepers, as shown in Fig. 329.

In India, the ordinary gauge, termed the broad-gauge, is $5\frac{1}{2}$ feet; and the meter-gauge, 3 feet $3\frac{3}{8}$ inches, corresponding to sleepers 10 feet by 12 inches by 6 inches or $9\frac{1}{2}$ feet by 10 inches by 5 inches, and 8 feet by 8 inches by $4\frac{1}{2}$ inches respectively.

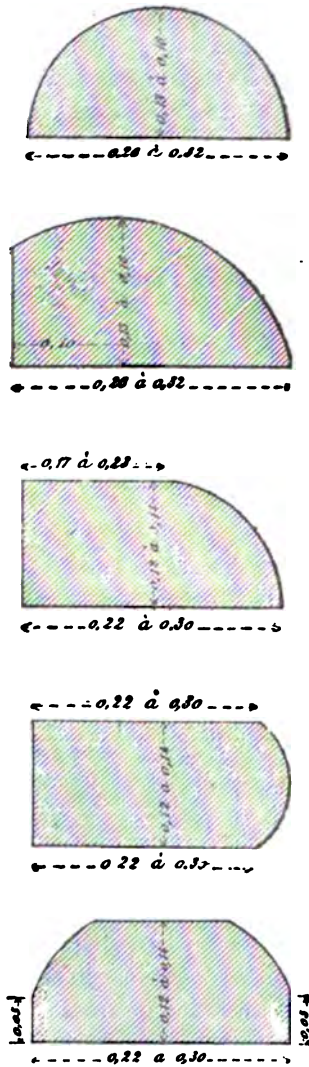

(Dimensions in meters.)

Fig. 329.—Different sections of railway-sleepers used in France. (After Boppe.)

The rails are placed on steel chairs fastened to the sleepers by iron spikes, oak trenails, or both, and it is essential that

there shall be no bad knots on the sleepers just where the chairs are fixed to them.—Tr.]

In Germany first-class sleepers are 2·7 m. long and 16 by 26 cm. in section; second class sleepers are 2·5 m. long and 15 by 25 cm. in section. On the average a sleeper contains 0·10 cu.m. ($3\frac{1}{2}$ cu. feet), and if the waste of wood in sawing them is considered each sleeper requires 0·13 cu.m. (4·55 cu. feet). In Belgium, France and Holland the sleepers are 2·50 to 2·75 m. long and with sections 13 by 26, 14 by 28, 15 by 30, 16 by 32, 18 by 35 cm.; as already stated, their shape need not be regular. They are therefore cheaper than English or German sleepers. It should be noted that the height of a sleeper has more effect on its durability than its width.

In 1902, the total length of railway lines in Germany was 53,000 km. (33,125 miles). There are on the average 1,300 sleepers per kilometer, averaging 0·1 cu.m. of wood. As the sleepers last about 10 years, every year about 6,890,000 sleepers have to be replaced, requiring 689,000 cu.m. of wood. Also about 900 km. of new lines are constructed requiring 120,000 cu.m. of wood. Hence the annual demands for wood for the German railway-sleepers are about 800,000 cubic meters, or 28 million cubic feet, which if the waste in sawing the sleepers is included means a drain on the forests of 36 million cubic feet, the annual produce of about a million acres of woodland; of the German sleepers 55 per cent. is coniferous, 40 per cent. oak and the rest chiefly beech.

It is evident that the greatest number of sleepers should be sawn from wood in the round. Experience has shown that in the sleepers $2\frac{1}{2}$ m. long and 16 by 24 cm. in section the following sleepers can be cut from round logs.

| No. of Sleepers. | Diameter of Log at small end. | |
|------------------|-------------------------------|---------|
| | Centimetres. | Inches. |
| 1 | 26 | 10 |
| 2 | 36 | 14 |
| 3 | 43 | 17 |
| 4 | 48 | 19 |

Wood of large dimensions, oakwood at any rate, is too expensive for railway-sleepers, so that only oaks of third class are used. As a rule from 30 to 40 per cent. of the wood is wasted.

Oakwood formerly was considered essential for railway-sleepers owing to its durability, extending to 10—16 years. Narrow-ringed larchwood had an average duration of 10 years, and close-ringed Scots pine with plenty of heartwood 7 to 9 years, no other European woods being utilisable unless impregnated with antiseptic substances. Now, owing to the increasing scarcity and cost of oakwood and the advantages of impregnating sleepers, impregnated pinewood as well as impregnated wood of beech, spruce and silver-fir are preferred. Beechwood absorbs creosote fully and is now used extensively. Experimental use is also made of pitch pine and quebracho wood. The question of impregnating wood has been dealt with already (p. 509).

Young oakwood on account of its superior density is better for railway-sleepers, when creosoted, than the wood of old trees. If many oak sleepers have shown little durability, that is due to the low class of timber used. The nature also of the bedding in which the sleepers are laid exercises considerable influence on their duration.

Iron has come recently into competition with wood for sleepers, the chief reason for its use being its great durability. During the years 1891 to 1896 on the Prussian State Railways, which use annually about $3\frac{1}{2}$ million sleepers, the use of iron sleepers has gone up from 17 per cent. in 1891 to 25·9 per cent. in 1896. Of the wooden sleepers, in 1896, 71·3 per cent. were of pine and 28·7 per cent. of oak, in 1895, 90 per cent. of the pine sleepers were imported but only 0·9 per cent. of the oak sleepers.

[The iron or steel sleepers are either trough-shaped or pot-shaped, the trough-shaped form being the best. The chief objection consists in a gradual change in the molecules due to the action of the traffic that renders this metal brittle. Wooden sleepers are heavier and more stable than metal sleepers. Another objection lies in the greater cost of steel sleepers; often in India the saline nature of the soil is

prejudicial to steel sleepers. No sleepers can yield a better running road for traffic than the creosoted red-deal sleepers of *Pinus sylvestris* from the Baltic, which are used almost exclusively in Britain.

In India, teak, deodar, sál, and *Xylia dolabriformis* are the chief woods used for sleepers, and 4 millions yearly are the estimated requirements for the future.

In America most sleepers are made from the longleaved or pitch pine (*P. palustris*); in Australia and S. Africa from species of *Eucalyptus*, though much red-deal from the Baltic is imported into S. Africa.—Tr.]

6. Wood used in Forts.

Palisades in fortresses are made of all kinds of wood, chiefly coniferous. Platforms for guns and bomb-proof and other sheltered parts of forts are made largely of all kinds of wood, chiefly oak and Scots pine.

7. Mining Timber.

In spite of the large use of iron in supporting mine-galleries, large quantities of pit-wood are used for this purpose, as well as for lining shafts in pumping-works, etc. In Germany, the annual production of 120 million tons of coal and lignite require annually 3·6 million cubic meters of wood (126,000,000 cubic feet), while for all the German mines, 4 million cubic meters of wood are required. Wood used in mines is exposed to damp air, damp and frequently wet soil, and, in the deeper mines, to a constant degree of comparatively high temperature. Every circumstance, therefore, tends to favour the decomposition of the wood, and it lasts seldom more than 4 to 6 years. If the demands were not so considerable, none but the most durable oakwood ought to be used. It is, however, more economical to use the wood which is locally more easily procurable; this is chiefly coniferous, of which larchwood is most durable, then resinous Scots pinewood, but in Germany even sprucewood is sometimes used. Among broadleaved trees beech is used most commonly, and largely so when shod with steel, as stamping hammers for pounding minerals.

B. Dankelmann gives the following data as regards the use of various woods for pit-props; **oak**, greatest strength and durability, but too dear; **beech** stands pressure, but has low transverse strength, not durable; **impregnated sprucewood** is better than pinewood owing to its more suitable shape; **pine** has greater strength and durability, but bad shape; **robinia** is equal to oak, but dear. *Vide* p. 106, where the latest French tests for pit-props are given.

With the exception of beams used vertically, dovetailed together in shafts, ladder-wood, and some other pieces, wood for mines is required chiefly in round logs free from bark. Different forms also of sawn wood are in demand for lining shafts, generally in the form of inferior coniferous boards and planks. Wood may be supplied in **full-lengthed logs**, which the mining carpenter reduces to the required dimensions; or in the form of **pit-props**, in which the chief bulk of mining timber is comprised, and which vary from three to eight inches in mid-diameter (not less than $2\frac{1}{2}$ inches at the smaller end), and 12 to 30 feet long, and even longer. Only about 15 to 20 per cent. of the mining-props are required in pieces measuring 12 to 16 inches, mid-diameter.

[Scots pine will yield pit-props when 40 years old, and birch at 25 years, and for British coal-mines over 600,000 tons of Cluster pine are imported annually from Bordeaux, where this tree is grown and tapped for resin in the extensive forests of the Landes and Gironde. This gives about 1 ton of wood for 30 tons of coal, the wood costing about 15/- a ton.—Tr.]

Wood is put to some other uses where it is subject to similar conditions as wood used in mines; for instance, **well-frames**, for which purpose resinous coniferous wood, especially that of larch, black pine, and Scots pine are suitable; also in cellars, for **bottle-racks**, for which oakwood, good pinewood (or iron) are chiefly used.

SECTION IV.—WOOD USED IN CONTACT WITH WATER.

1. *Bridges, etc.*

Wood used in watercourses and bridges is under very much the same circumstances as wood in contact with the ground,

except that it may be partly or entirely under water. All wooden bridges and works used in connection with them for strengthening the banks of watercourses, sluices, weirs, booms and other timber-catching apparatus on streams used for floating, require pieces of many different shapes. Although iron bridges are now becoming usual even across narrow streams, and to a large extent roads are replacing water-carriage for timber, yet the importance of canals for cheap traffic of heavy goods is being felt more and more, so that very large quantities of timber are required in hydraulic engineering.

Bridges are boarded usually with beech, which gives a smoother surface and is less liable to splinter than oak or coniferous wood, but the considerable amount of warping and shrinking of beechwood must be allowed for.

Timber thus used is exposed greatly to decay, so that oakwood and resinous heartwood of larch and Scots pine are employed generally for these purposes. In the case of works for floating timber, it would be highly advantageous were the best wood used, but owing to its abundance in mountainous districts, and to the great cost of oak and larch, sprucewood usually is employed, although its durability is small.

Water-wheels also, for flourmills, sawmills and mills for other purposes, should be made of oakwood, but are made usually of the wood of Scots pine, larch or even spruce. The axle of a water-wheel must be thoroughly sound and free from flaws; it is seldom more than 18 feet long, and is made usually of the wood of oak, larch, Scots pine, spruce or even beech. The diameter of the axle does not depend entirely on the size of the wheel, and the amount of the work to be done, but also according as the spokes of the wheels are dovetailed into the axle, or fastened to it tangentially.

Iron wheel-axles rest on beech or hornbeam bearings, which are supported by a strong framework of oak, Scots pine, larch, etc.

2. *Fascines.*

Fascines are often used to support banks, a fascine being a bundle of young stool-shoots of different species and dimensions. Their usual length is 10 feet to 12 feet, the height to

which the coppice grows, and they should measure 12 inches in diameter at the larger end. Fascines are used transversely to the bank of the stream; long thin fascines, made of the finest available material, only 5 or 6 inches thick, but 24 to 50 feet long, which are bound with withes at intervals of ten inches being pegged down over them. Another kind of fascine is 12 to 20 feet long and 24 to 36 inches across, filled with heavy stones, and sunk alongside the bank in deeper water where the stream is strong. Quick-growing trees and shrubs with five to six years' rotation, especially willows,* are used for fascines; also buckthorn, euonymus, viburnum, privet, alder, elder, hazel, poplars, ash and thorns.

The best time for felling coppice for fascines is in March, just before the spring-shoots come out. This is satisfactory, alike to the engineer and the forester, as the former gets the material when it is richest in sap and therefore heaviest, whilst the latter cuts the coppice just before sprouting, which secures a good reproduction from the stools.

For wattle-fences, duck-decoys, etc., osier-willows yield the best material.

SECTION V.—WOOD USED IN MACHINERY.

Iron and steel are fast replacing wood in machinery; it is only in purely agricultural districts that any machines are made wholly of wood. It is therefore only parts of machinery, chiefly the frame-work, bearings and fixings of heavy machinery, that are made of wood. Wood is used chiefly in sawmills, flourmills, etc., and in machinery for driving wooden stamping-hammers. Even in large factories, however, wood is still required; this is generally wood of dense structure, which resists shocks and friction.

In all works driven by water-power, the water-wheel is the most important implement and has been referred to already. In extensive plains, sails of windmills replace the water-wheel; they are made always of coniferous wood, chiefly of Scots pinewood of best quality, such as is required for masts of ships and are sometimes very large. Pieces should

* *Salix viminalis, fragilis, alba, rubra, amygdalina, triandra, acuminata, etc.*

tail-off at the small end. Steam-power is however replacing wind-power to a great extent.

As regards the demands for wood for the interior of factories the following short remarks will be made:—

All wheels are made of iron, but hornbeam and dogwood are used sometimes for cogs. In sawmills, the supports of the saw and the bed are made chiefly of coniferous wood, the rollers of the latter are of wood of hornbeam, elm or oak. In flour-mills, except the wheels, most of the fittings, such as the hoppers and meal-bins are made of coniferous wood. The case in which the mill-stones work should be of Scots pine-wood as free from resin as possible, or of silver-fir wood. All parts of the mill where friction is exerted should be of beech or hornbeam. In oil-mills and stamping-works, hard broad-leaved wood, such as that of beech, hornbeam, oak and ash, is required rather than coniferous wood, and also for pounding troughs in oil, tan, powder and bone-mills.

Stamping-hammers are now made usually of iron, but in mountainous forest districts, many are still of wood bound with iron, and large quantities of beech, birch or hornbeam logs are used for them, in round pieces 8 to 10 inches in diameter and 6 to 8 feet long. These pieces often require replacing 6 to 8 times in a year. They come constantly in contact with the glowing mass of iron below them, on which water is poured, which causes them to crack in all directions and wear out rapidly.

The anvil-stock below the hammers is made of an oak log at least 8 feet in diameter and 6 feet long, which is bound with iron and let firmly into the ground.

Wood is used largely in all factories for frame-work, work-tables, floors, etc., and after coniferous wood, beechwood in thick planks and scantling is employed chiefly.

SECTION VI.—BUILDING OF SHIPS AND BOATS.

1. *General Account.*

In no industry has wood of recent years been replaced more largely by iron than in shipbuilding. It is chiefly the larger men-of-war, steamers, and sailing ships which are built of

iron. Iron ships are most resisting to storms, of larger burden, easier to repair and more durable than wooden ships.

As regards the shape, there is a considerable difference between ships intended for the sea, and fresh-water barges: the former are comparatively short compared with their breadth, with keels which run straight from end to end of the ship; whilst all the other lines are of various degrees of curvature. This curved shape is given to ships by means of ribs, which are made partly by joining different pieces of wood, but also by using curved pieces.

Fresh-water barges have no keels, but a broad flat bottom on which the knee-pieces are fastened at a sharp angle, so that the straight line is much more frequent in their construction than in that of ships. The chief strength in ships consists in the ribs, which are very close together, the outer planking being less important; in barges the ribs are much further apart, and the planking is of greater importance.

The demands on wood for building ships and boats depends on the species of wood, its quality, shape and strength.

2. *Species and Quality.*

The wood of **teak** (*Tectona grandis*) is used chiefly in shipbuilding. The preference given to it is due to its large dimensions, its great durability, its being only slightly subject to warp, a matter of great importance owing to the varying degrees of insolation and humidity to which a ship is subject; teak-wood also is not affected by contact with iron, so that there is no rust such as the tannin in oakwood causes, which loosens bolts fastening iron plates to oaken ribs of ships. Next to teakwood comes **oakwood**, which must be durable and strong. Only heartwood is used, and with broad uniform annual zones, but not broader than 6 mm. (4 to an inch); it should be of uniform colour and with a fresh scent of tannin.

It is uncertain whether the pedunculate or sessile oak yields the best wood for shipbuilding, but most ships are built of pedunculate oak. For the Austrian navy, the wood of the pubescent oak is preferred for ribs; in Norway, sessile oak is used chiefly. The best oak for shipbuilding is that grown on rich soil and in a warm climate, even the coasts of the

Adriatic Sea, Istria, Carinthia and Steiermark yield excellent oakwood, while Slavonic, Polish and Spessart oak is less valuable for shipbuilding. In Britain, that from the south and west of England and from France is most prized. In N. America, *Quercus alba*; in Japan, the evergreen oaks *Q. crispula* and *Q. glandulifera* are used for ships. In Europe, pitch-pine wood and that of species of *Eucalyptus* also are used; for barges, conifers, especially larch and pines.

[Jarrah (*Eucalyptus marginata*) resists the teredo, it weighs about 60 lbs. to the cubic foot, being about the same density as teak. It is less inflammable than other woods and resists corrosion by iron, is not subject to dry rot and has not been known for the last eighty years to show signs of decay. It might thus be used as a substitute for teak, in shipbuilding.—Tr.]

Next to oakwood, wood of the Scots pine or red-deal is used largely in shipbuilding, chiefly for masts and rudders. This timber varies in quality much more than oakwood, and the best qualities of red-deal are strongly resinous and have narrow annual zones.

All wood for masts and rudders should be straight and cylindrical, free from knots, elastic and uniformly resinous throughout. The sapwood, which is always trimmed-off, should be narrow, being only $\frac{1}{2}$ to $\frac{1}{3}$ of the diameter in the best woods. The large masts taken from the Hauptmoor Forest near Bamberg have frequently only 1 to 2 centimeters ($\frac{3}{8}$ to $\frac{1}{2}$ of an inch) of sapwood, and even this full of turpentine. Too highly resinous woods are not esteemed, as they are less elastic and strong. At the same time, the annual rings should not be too narrow, and experience proves that a breadth of ring of 0.75 to 2.00 mm. ($\frac{3}{10}$ to $\frac{1}{2}$ of an inch), provided it is continued uniformly to old age, characterises the best sort of mast-wood. As regards colour, Scots pine-wood, of clean, bright, uniformly yellow colour, is preferred.

The best red-deal comes from the north, especially the Baltic coasts, also from Scotland and Norway. The best mast-wood comes from Riga, and is superior to all other mastwood in elasticity, strength and durability. Hardly any mastwood of the old excellent quality is now to be had, owing to the prevalence of even-aged woods with forced growth.

Larchwood from high latitudes, or altitudes, comes next to the Scots-pine as mastwood, and this species is used largely for masts in the Russian navy, where the northern Ural mountains yield splendid larch-timber. Spruce and silver-fir yield only inferior mastwood, their timber not being strong enough for the purpose. In the Austrian mercantile navy, however, sprucewood from Carinthia and other provinces is largely used for masts. Spruce masts also are used largely for sailing-boats on most of the German rivers. [*Picea Omorica* was used in Venice for masts.—Tr.]

American and Australian conifers also are used for masts, such as the Douglas-fir, Canadian Weymouth-pine, Kauri (*Dammara australis*) of New Zealand, all of which come to European dockyards in increasing quantities.

For the inner lining of ships, besides the woods already mentioned, of which teak, oak, larch, and Scots-pine are used largely for deck-planking, many other inferior species are employed. Injected beechwood is used sometimes, not only for keels, but for the whole framework of ships on the Dalmatian coast; the wood of elm, maple, lime, etc.; as well as ornamental woods such as mahogany, walnut, birds-eye maple, etc., are used in fitting-up cabins, saloons, etc.; guaiacum-wood and boxwood are used for models and pulleys.

[Herring boats in Scotland are made of larchwood, and so are many English barges. Cedrela-wood is used for river boats, as well as spruce, oak and ash.—Tr.]

3. *Permissible Defects.*

All wood used for shipbuilding cannot be free entirely from defects, for if that were the case, sufficient wood would not be obtainable from a large forest district to make a single ship, as old oakwood is seldom perfectly sound. Wood which, owing to its dimensions, is ranked as first-class, may have small local defects which do not weaken the balks. Brown spots and rings at the larger end of a balk, provided they do not penetrate far into the wood, and may be removed by shortening the balk, need not cause it to be rejected. Where small patches of red or white rot and other similar defects occur, which are dried thoroughly and are not expected

to extend any further, the decision of the admissibility of the affected wood must be left to an expert. Large heart-shakes, frost-cracks, twisted fibre, deep-going black and brown marks rotten places descending from branches, are defects, which naturally exclude the timber possessing them from use in shipbuilding.

4. Shape and Dimensions.

All shipbuilding timber is either wood for construction, or for masts or spars.

(a) **Timber used in Construction.**—This comprises curved and long wood.

Curved or compass timber is used chiefly in the framework

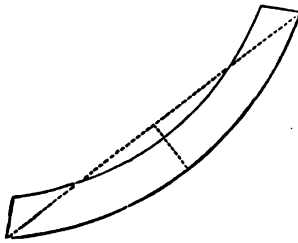

Fig. 330.—Uniformly curved piece.

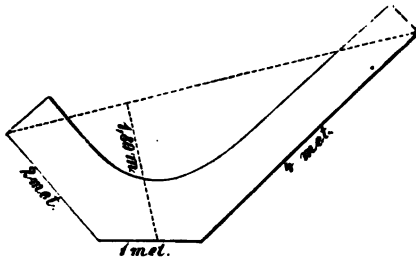

Fig. 332.—Knee-piece.

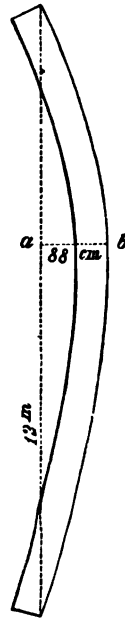

Fig. 331.—Curvature one third from end.

of ships. As a rule, the curvature should be uniform throughout the piece (Fig. 330), or greatest at one-third from one of its ends, and when this is one-third the distance from its larger end (Fig. 331), the piece is most valuable. Some of these

pieces are 30 to 40 feet long. Curved woods are required chiefly which have a *sagitta* or camber of 2·5 and 1·5 centimeters per meter (*i.e.* $\frac{1}{40}$ and $\frac{3}{200}$), but this may be exceeded in certain pieces as in Fig. 332. The beams used for supporting the deck are much less curved.

Wood is now bent artificially for shipbuilding, as in certain factories in Hungary, but probably it is then weaker than naturally curved wood.

Kneed timber is formed where a bough parts from the parent stem as in Fig. 333. The branch should accord in its dimensions with the stem, and not be too small when compared with the latter.

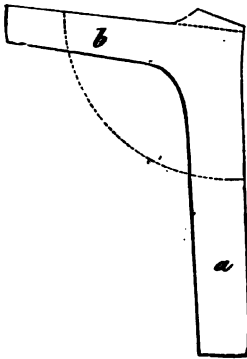

Fig. 333.—Knee-piece.

The chief use of **knee-pieces** is in the construction of river-barges; wood of smaller size is then required than for shipbuilding, and in that case the arm *a*, Fig. 333, is much longer than *b*, whilst for ships it is only twice as long. In North Germany, where oak is scarce, large, branchy Scots-pines are used for knees, which otherwise would be fit only for firewood. Such knees last 10 years in barges. Beech-

wood also may be so used in the interior of vessels. In Saxony use is made of the lower part of a spruce stem with a strong root attached; this may be 15 to 20 feet long, and 7 to 10 inches thick.

It is difficult to give the proper dimensions for compass-timber used in shipbuilding, but the longer and thicker, the more valuable they are; no sapwood is included; 10 inches diameter, and 15 to 20 feet length, represent the minimum dimensions. When used for barges and boats the diameter of knee-pieces may go down to 4 inches.

Long, straight pieces of timber are used for **keels**, but are sawn chiefly into planks for the inner, or outer, casing of vessels, and even larger sizes are required than for compass-timber: lengths below 24 to 30 feet, and a diameter of less than a foot at the smaller end, are not permissible.

Only in the case of planks for barges are much smaller sizes used.

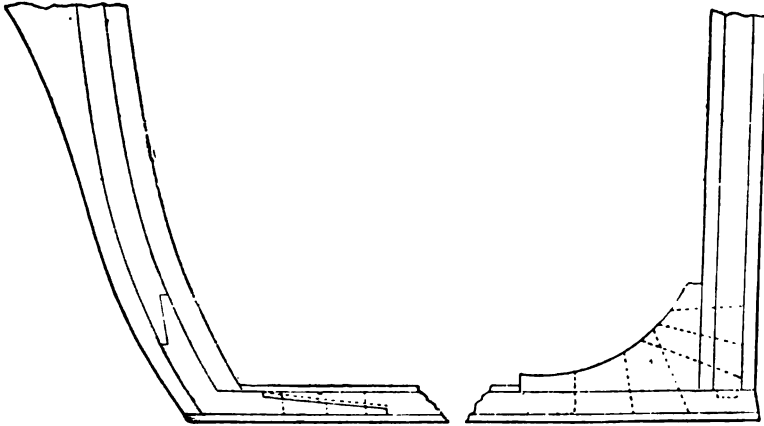

Fig. 334.—Longitudinal section of a ship. (After Boppe.)

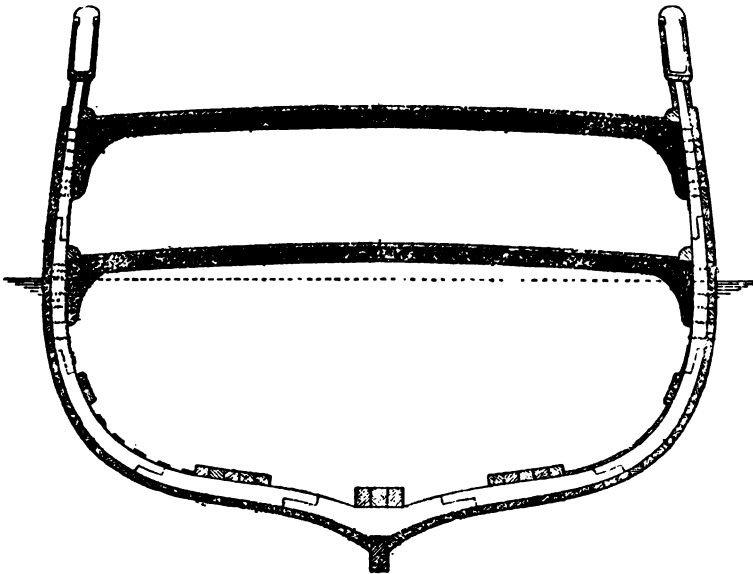

Fig. 335.—Transverse section of a ship. (After Boppe.)

Figs. 334 and 335 show two sections of a ship and where the curved pieces are used.

(b) **Mast- and Spar-Wood.**—Wood for masts, booms, and spars should be perfectly straight, as cylindrical as possible, and when required for large ships, of the largest possible dimensions. First-class masts must measure, free from sap-wood, at least 60 to 80 feet in length and be 16 to 20 inches in diameter at the small end; formerly such masts were procurable in Hauptsmoor, near Bamberg. Almost exclusively coniferous wood was used for masts, but the use of such wood of the largest dimensions has been replaced by that of hollow steel masts. Smaller spars still are required which are of dimensions within the powers of most forests to supply.

5. *Supply of Timber for Shipbuilding.*

The supply of oak-timber from German forests is only small. The system of coppice-with-standards is better adapted for the supply of oak-timber for shipbuilding than the even-aged systems, and thus France, where this system is very prevalent, produces large quantities of suitable oakwood. Most of the timbers used in shipbuilding are compass-timbers, which are much more abundant in uneven-aged wood, and even in hedgerow trees, than in even-aged high-forest. The wood of standards in coppice is also harder, and of better quality for the purpose, growing as they do, isolated or in groups, with plenty of room both for their roots and crowns.

As regards mastwood the opposite conditions prevail; slow, uniform, and prolonged growth are required, and the trees must be grown close until they have attained their full height, in a uniformly moist soil, a situation sheltered from storms, and a cold climate, such as the Baltic Provinces. Only individual trees in such woods will attain sufficient dimensions for the largest masts, and on them great care and attention must be bestowed.

SECTION VII.—JOINERY AND CABINET-MAKING.

Joiners and cabinet-makers use large quantities of wood, which is usually the only material they employ. These industries have become highly specialised, and there are all

grades of artisans employed—the joiner, the cabinet-maker, the wood-carver, model-maker, and tool-maker.

1. *Joinery.*

The joiner constructs the inner fittings and finishing of houses, such as the floors, doors, window-cases, wainscoting, staircases, etc. The material he uses is chiefly sawn timber, planks, boards and scantling. He does not work usually with roughly-sawn material, but with planed material, which is sold by the wood-merchants ready for use, and often with the requisite mouldings. Thus much labour is spared which would cost more if executed by a joiner than when made by special machinery. Hardly any wood in the round, or roughly-sawn wood, is used by the joiner.

The wood used is chiefly coniferous, and broadleaved wood to a less degree. Boards, planks, and upright pieces are chiefly of spruce and Scots-pine, and after this, of silver-fir, larch, or Weymouth-pine. Owing to its white colour spruce is preferred for flooring. Silver-fir turns grey and splinters more readily than spruce. Pines and larch are darker coloured but more durable than spruce. For wainscoting, Cembran pine and larch yield excellent wood. The joiner always prefers fine-zoned coniferous wood, free from knots, from cool mountain regions or from the north, to coarser material, except in cheaply run-up buildings. Amongst broadleaved woods oakwood is preferred, and is used extensively for parquetry floors, for which the blocks are prepared specially by machinery. It is also used in short, flat, planed pieces, only wood of large trees without knots being employed, as the sapwood is rejected. Oakwood is less frequently used for friezes, door- and wall-panels. Oak panelling made of wood showing the silver grain is used in dining-halls, staircases, churches and other public edifices.

Fine mosaic parquetry floors are made of woods of different colours, such as oak, walnut, birch, teak, etc., and cut in different ways as regards the grain. Some of the woods used are coloured by strong acids, others preserve their natural tints. Oak also is used for staircases, and so is beechwood, and often ash is turned for banisters. Beechwood

also is used similarly, but is inferior to oakwood in texture, capability of being polished and resistance to moisture and dryness. Pitch-pine wood also is used, being very hard and resinous also the wood of Douglas-fir. All these pieces are longitudinal sections cut between the tangential and radial directions.

2. *Cabinet-making.*

Furniture is made nowadays more in factories than by individual makers. It makes a greater demand on the quality and variety of the wood used than joiners' work, and equals it in the quantity of wood used.

Sawn timber is used in the form of planks and scantling and round wood of all dimensions. Veneer of finely-marked wood is used frequently to face coarser material, and its use is justified by the fact that these thin strips of wood do not crack, as is always more or less the case with solid woodwork. Only the more valuable hardwoods are used in the round by the cabinet-maker.

All kinds of wood are used, and for coarser furniture, kitchens, cupboards, school-benches, frames, chests, cheap coffins, etc., coniferous woods, elmwood and soft broadleaved woods are used. The inner part of other furniture is made of these woods and then veneer glued on to it, or they may be covered with upholstery. Oakwood often is used for the inner part of the better kind of veneered furniture.

Solid furniture is made of broadleaved species, such as oak, walnut, cherry, birch, maple, ash, elm, etc. There is, however, a limit to the construction of solid wood furniture owing to its weight. Beechwood is used largely wherever friction and wear-and-tear will be considerable, as in work-tables, chairs, wedges, etc. Often it is used stained in various tints to imitate more valuable woods.

The cabinet-maker selects his material for its fine colour, good texture, freedom from knots, ease in working, capability of being polished, and for being little liable to warp or crack. Finely-marked and wavy woods are esteemed.

In order to reduce warping and shrinkage as much as possible, the cabinet-maker uses only thoroughly seasoned wood; he does not care for the most durable wood, but prefers

wood which is easily worked, with, or against, the grain. He therefore means quite a different kind of oakwood from that esteemed by the ship-builder when he speaks of good oakwood, and prefers that of the sessile to the pedunculate oak. The best cabinet-maker's oakwood comes from Russia, the Spessart, the Pfalz, the Silesian mountains, from French high forests, and generally from mountain districts with a slow rate of growth; on account of its lower density it is less liable to shrinkage. Slavonian oak and that from coppice-with-standards is much less prized.

Beechwood would be prized much more highly for furniture, on account of its dense uniform texture, were it more frequently obtainable from middling sized trees in quarter-balks from which the core of the tree has been excluded. Such wood is excellent material for working up, and is now being used extensively for bent-wood* furniture.

Thoroughly sound beech stem-wood free from knots is used for bent-wood furniture, and young wood is preferred to old. Even large pieces may be bent easily, and the bending dispenses with sharp corners, dovetailing and glueing, the pieces merely being bent and screwed together. The wood is felled in summer and sawn into rectangular pieces 6 to 10 feet long and $1\frac{1}{2}$ to 2 inches in diameter, which give a waste of 60 to 70 per cent.

Veneers of maple, walnut, and less frequently of beech, are glued together and made into the seats of chairs. These are being used in increasing numbers.

Amongst softwoods of broadleaved species, planks of poplar-wood are used chiefly under veneer; that of the black poplar or of the Canadian (Italian) poplar is preferred, the wood of the white poplar being very subject to cup-shake. The greenish-yellow wood of the tulip tree, *Liriodendron tulipiferum*, known as poplar-wood, or whitewood, is exported extensively in large balks from America to Europe to serve as backing for veneer. These woods are of very uniform texture, and the spring-wood does not shrink so much as in other woods, causing the summer-wood to project beyond it and

* See an excellent article by Exner on bending wood, in the Centralblatt für das gesamte Forstwesen. 1876.

giving the veneer, which is glued outside the piece of furniture, a wavy surface.

3. *Artistic and Fancy Ware.*

The manufacture of artistic and fancy ware forms a branch of cabinet-making, and is used in the finer pieces of furniture, picture-frames, clock-cases, etc.; according to the present fashion (old German, Italian Renaissance, Rococo styles, etc.) it is accompanied more or less by artistic carving, inlaying with metals, mosaic work, etc.

Walnut, oak, fruit-trees, maples, birch and coniferous wood are used, partly solid and partly veneered.

Many exotic woods are used, especially mahogany and foreign walnut, maple and ash-burrs; also ebony, rosewood, satinwood, olive-wood, violet-wood, thuya, juniper and cypress wood, teak and pitch-pine.

Wooden frames for mirrors and pictures, which are made in Saxon and Bavarian factories and also by individual hand-work, are chiefly of coniferous wood, but also of oak and ash.

4. *Model-making.*

All models used for cast-metal works, of machines, implements, etc., are made chiefly of coniferous planks and scantling of the best quality, but also of lime, maple, alder, ash, pear and beechwood. The model-maker is a real artist in his line.

5. *Wood for Tools and Implements.*

Plane-boxes, turning-lathes, presses, joiners' benches, mangles, handles of tools, etc., are made chiefly of beech, hornbeam, oak and ash. The framework of agricultural implements also uses up much coniferous wood, as well as the above species.

6. *Miscellaneous Goods.*

Many other industries may be added, which are also branches of cabinet-making, such as the manufacture of billiard-tables, boxes, sword-sheaths, and articles used in dairies and cheese-making establishments.

SECTION VIII.—MISCELLANEOUS USES OF WOOD.

A very large quantity of wood is consumed in making **packing-cases**, for which coniferous wood of middling or inferior quality, and side-pieces and other waste timber are used, especially when the cases are fastened together by bands of zinc or iron. Casks used for packing also are made of inferior coniferous wood. Better and more durable classes of packing-cases are, however, coming more and more into use, beech being employed largely.

For small boxes used for packing fancy goods, soap and other small articles, wood of conifers, poplar, aspen and lime are used, cut like veneers with special saws, or even a whole round block of wood is revolved against a sharp fixed blade, and converted into a sheet of wood for this purpose. In France, light wood such as aspen is thus used to reduce as much as possible the gross weight of the goods. Wood-pulp and tin are used frequently instead of wood.

German cigar-boxes are made usually of alderwood, and the pieces without bark should be 9 inches to 1 foot in diameter and free from knots; they are sawn into planks, and the latter reduced to thin boards by the circular saw. It is a pity that there is not more good alderwood available.

The wood of the West Indian cedar (*Cedrela odorata*, L.), allied to mahogany, is imported in large balks, not only for boxes for the best cigars, but also for inferior ones, especially in N. Germany, and this in spite of freights and import duty. Attempts to use the wood of poplar and lime for boxes for cheap cigars, and especially stained beechwood, have failed, owing to the warping of the wood. Cigars are pressed into a good shape in presses made below of beechwood and above of spruce, the groove and presses being of beech and hornbeam. Entire stems of beech are used for this purpose at Hanau, Bremen, and Wörth-am-Main, but this industry has lately suffered from American competition.

A very large quantity of wood is used annually in the numerous **pianoforte-factories**, which in Germany alone in 1899 turned out about 105,000 pianos, worth £2,000,000. In piano-making all kinds of sawn wood (oak, beech, walnut,

maple, lime and poplar, etc.) are used, but the wood for sounding-boards is of a special kind. For this only coniferous wood is used, chiefly spruce, more rarely silver-fir.

The simple anatomical construction of sprucewood and the absence of vessels, the extremely fine, evenly distributed medullary rays, the straight and long-fibred nature of the wood, and above all its uniform structure, render it most suitable of all woods for reverberating pure tones. Such wood must have narrow and uniform annual zones, must have no knots, contain little resin, be straight-fibred and of low specific gravity, 0.40 to 0.45. The best wood for musical instruments should have zones between 1.5 and 2 mm., and the summer-wood $\frac{1}{4}$ to $\frac{1}{5}$ of the zone. Trees producing such wood grow in mountain-regions at altitudes between 2,500 and 4,500 feet above sea-level, on cool and not too fertile localities. They are grown generally in selection forests, where the trees get little room for development, until they are middle-aged, but more room as old trees.

Bubenbach in the Schwartzenberg property, the ranges of Tuffet, Neutal and Schattawa in the Böhmerwald, also the Bavarian forest, in the St. Oswald, Manth, and other ranges, the Bavarian Alps, ranges of Fischert and Trumenstadt, and the French Jura and Alps are renowned for the production of this wood, also Lemberg in Galicia, and North America. The trees are sawn into quarters, and then along the radius, into planks $\frac{3}{4}$ inch thick; they are seasoned, planed, and sorted according to their tones. Recently, attempts have been made to produce such wood artificially by glueing together thin veneers of wood by means of turpentine, shellac, gum, etc., and pressing it into planks.

Straight-grained beechwood in planks $1\frac{1}{2}$ inches thick is used largely for pianos, being cut along the radius, which prevents it warping as much as ordinary beechwood.

Many foreign woods are used for piano-cases—mahogany, American walnut and maple, padauk, satinwood, etc., ebony for keys, and Florida-cedar for the hammers. Woods similar to those in use for pianos are also employed for harmoniums and organs.

Venetian blinds and shutters use up much light wood,

especially spruce and silver-fir. Wood of similar quality to that used for sounding-boards is used for the better sorts of blinds, much of it coming from old silver-firs in Bavaria.

Cornices of all kinds may be mentioned here, for which the best split coniferous wood is used.

SECTION IX.—WOOD USED BY THE WHEELWRIGHT.

The wheelwright, besides carts, also makes a number of articles used in agricultural work, and comes in this respect next to the blacksmith as an indispensable village artisan; usually he obtains his wood directly from the forest. Wheelwrights' wood should be even-grained, long-fibred, tough and dense, and free from knots and all patches of decay.

The chief industry of the wheelwright is the construction of carts and waggons, the principal parts of which are the wheels, axles and shafts.

The wheels consist of the nave, spokes, felloes and tires.

The nave or hub is made generally of oak, elm or ash, and in the case of carriages, of walnut, or, more recently, of plane-wood. The wood should be hard and dense to prevent the loosening of the spokes, which are mortised into the nave.

[It is said that wych-elmwood is tougher, finer-grained, and more easily bent than common elm-wood; both woods are largely used for naves and felloes.—Tr.]

The felloes, which are mortised together in a circle, are made generally of split wood of elm, beech, birch, ash or robinia, elm being best for the purpose. The wood should, if possible, be curved naturally, and as the pieces are only

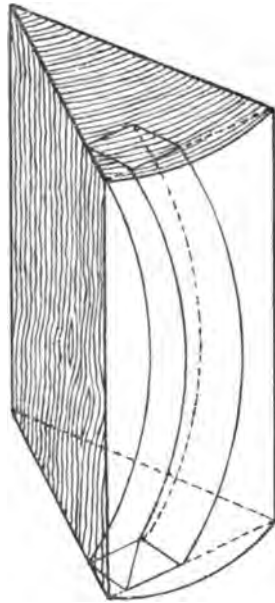

Fig. 336.—Mode of cutting out felloes. (After Fernandez.*)

* Fernandez, "Utilization of Forests," p. 54.

about 2 feet long, there is generally little difficulty in getting nearly the suitable curve, the wood being then cut into shape with a band-saw.

There is a large export of felloes from forests, and in Germany they are usually sawn out of split pieces, with their flat sides parallel to the annual rings (Fig. 936), which enables them best to support the pressure of the spokes without warping. Where felloes are sawn out of ordinary planks 3 to 6 inches thick, they are much weaker than those made as above. A bent rim sometimes is used for the wheels of light carriages, being made of one piece of steamed split-wood; larch, ash, oak, beech, birch, or hickory are employed.

Spokes are made of cloven oak and ash, also of robinia, American oakwood or hickory. Wood thoroughly tough and strong, and not likely to shrink much in dry, hot weather, should be used.

[Spokes vary greatly in size, the smallest being 2 to 2½ feet long by 2 to 2½ inches by 1 to 1½ inches and tapering down to about ½ inch at the smaller end; these are used for omnibuses and coaches. Cartwheel spokes are heavier, but of about the same length. Large spokes 5 inches by 3 inches at the thicker end are made frequently.—Tr.]

The principal piece of the body of a timber-cart is the **pole**, which is made of split oak, birch, or ash. The axles of the wheels are made usually of steel, or of strong oak or ash-wood, with steel ends on which the wheels revolve. **Carriage-poles** are preferred of birch, but are made also of ash and oak; and for **shafts**, ash is preferred to oak, the latter, when strong, being usually too heavy, whilst ash bends and yields better without breaking. The best shafts are of hickory or lancewood (*Guatteria vulgaris*). The size for shafts is 8 to 10 feet by 2½ to 4 inches square.

The **framework of carts and carriages** must be made of well-seasoned wood, beech, ash and oak being used, the panels of carriages being of lime or poplar.

Ploughs and harrows are made of heavy wood wherever iron is not used in their construction, and crooked pieces of oak, ash and elm-wood are used. Teeth of harrows, if not of iron, are made of hornbeam-wood.

For sledges, generally oak, birch, elm, ash and beech are used; their horns are made of the best beech, maple, or birch-wood. Wheelbarrows also require curved wood.

Ladders consist of two uprights and the rungs, the former made of coniferous wood, generally of a pole sawn in two, and the latter of cloven wood of oak, ash or robinia. Mangers have a similar construction to ladders, and are made of beech, elm, birch or oak.

The manufacture of the handles of tools requires large quantities of wood, as handles of axes and hatchets, also handles of hammers, spades, scythes, hoes, thrashing flails, etc.

For axe-handles, split pieces of young beech saplings chiefly are used, as well as of hickory, ash, hornbeam, oak, juniper, and the service-tree. Oak, beech, or birch handles for scythes; for spades and hoes, hickory, ash, elm, robinia, oak and birch are used. Wooden hay-forks are of forked birch, ash, aspen or nettle-tree (*Celtis*); wooden brakes for wheels, of beech or birch.

In making all these articles the wheelwright uses logs and butts of different dimensions, above all, poles of 3 to 8 inches in diameter of oak, ash, elm and birch; but all kinds of wood are used, chiefly cloven wood, from which the core and sapwood have been removed, as such material is less liable to warp or crack. Curved and bent wood is often of special value to the wheelwright, although frequently such pieces are made artificially.

Elmwood affords excellent material for the wheelwright, sometimes that of the common elm and sometimes that of the wych-elm being preferred, but it is very difficult to work, and costs the artificer more labour and trouble than he often cares to bestow. Near the sea-coast much exotic wood, ready cut to size, is used by wheelwrights, especially American hickory (*Hicoria*) and oak (chiefly *Quercus virens*).

Butchers' blocks use up much ash, as well as beech and oak, though elmwood is best for the purpose, if it can be obtained of suitable dimensions. Pieces of large diameter, and thoroughly sound, are required. Many hundred beech butchers' blocks from the Spessart go down to the Rhine annually; they are made often of 6 to 8 pieces of wood bound together by iron hoops.

The manufacture of railway-carriages and trucks consumes enormous quantities of wood of high quality. The horizontal beams, underlying all passenger-carriages as well as goods-trucks, are made of squared oak timber. They lie between the iron girders supporting the carriage, and rest directly on the axles. Broad-ringed ashwood is preferred for the uprights, these are dove-tailed into the horizontal beams and pieces, which unite with them to form the framework of the carriage, but sometimes oakwood is used. The flatly-curved roof-supports are made of bent elm, ash, or Scots pinewood. For roofing the long dining-cars and sleeping saloon-carriages, 60 to 70 feet coniferous balks are used. All panels and the interior work are made of light woods, coniferous, poplar-wood, etc., also of sheet-iron, and, more recently, in England, of pressed oakum made out of old ship-cables. The brakes are made of poplar, aspen or beech.

In the frequently very luxurious passenger-carriages and sleeping-cars, valuable ornamental veneers are used in the internal fittings; or exotic woods, such as teak, pitch-pine, American walnut, fine ash, maple or mahogany, in a solid form.

Even the iron goods-trucks require about 86 cubic feet of ash and oak in the construction of each truck, and there are 300,000 goods-trucks on the German railway-lines alone, of which 85 per cent. are roofed.

SECTION X.—COOPERS' WORK.

The cooper makes all kinds of open or closed wooden vessels to contain liquids and dry articles. A distinction may be made between casks intended to hold spirituous liquors, to hold other fluids, or for dry goods, such as butter, sugar, herrings, etc. Nowadays casks are made chiefly in factories.

1. *Casks for Spirituous Liquors.*

The most important use for coopers' timber, and that employs large quantities of the best kinds of wood, is the manufacture of casks for spirituous liquors, such as wine,

beer or cider, etc. A good cask should be as durable and strong as possible, in order to withstand the inevitable shocks and rough treatment to which it will be subjected during transport. It must possess the property of retaining its liquid contents, so that the latter does not escape in drops or vapour through the wood-pores. Hardly any wood but oak-wood will fulfil all these conditions, and especially pedunculate oakwood (zones not exceeding 6 mm.) from favourable localities, that is

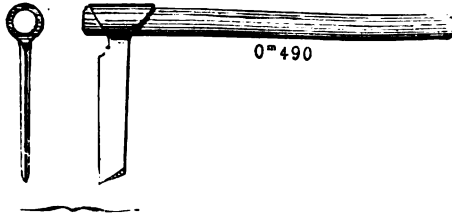

Fig. 337.—The divider. (After Boppe.)

superior to northern sessile oak for staves. The latter should be used in thicker staves to compensate for its inferior density, and is used chiefly for large vats.

In Italy, robinia-wood has a good repute for staves, whilst sweet chestnut, Turkey and evergreen oaks are less valuable. Attempts have been made to utilise beechwood for wine and

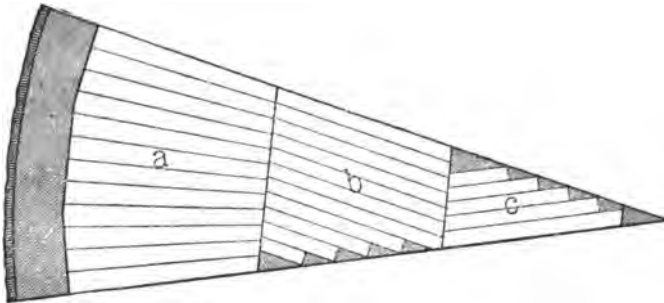

Fig. 338.—Method of splitting wood for cask staves. (After Boppe.)

beer-barrels, but without success. For spirit-casks, ash, robinia, and mountain ash-wood also are used.

Casks are composed of **side-staves**, **head-pieces** and **hoops**.

The side-staves should be broadest at their centres and taper off towards their ends, in order to allow for the bulging of the casks; they should, however, be somewhat thick again

at their ends, as a notch has to be cut there to admit the head-pieces. The two broadest staves are, that on which the cask rests, and the opposite one in which the bung is inserted.

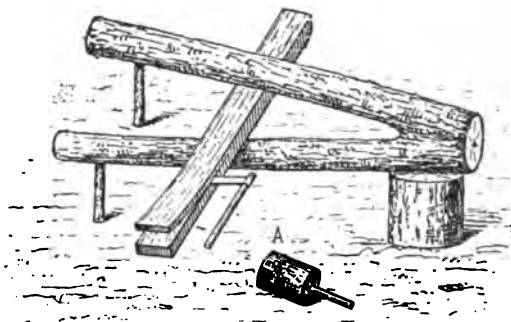

Fig. 339.—Stave-maker's bench with divider and mallet. (After Boppe.)

The best wood is used for these two staves. From three to five head-pieces are used at either end of a cask, being dove-tailed together. The tops and bottoms of small casks are

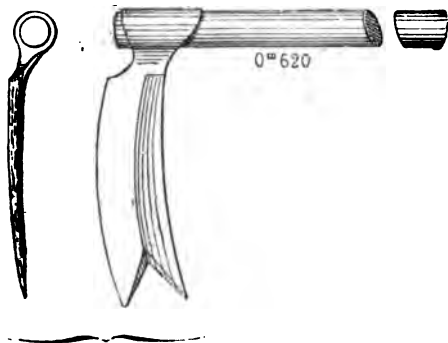

Fig. 340.—The Shave.

flat, but in larger ones they are somewhat curved inwards, in order better to withstand the pressure of the liquid inside.

Wood for staves is cloven usually in the forest by special artificers, and straight-grained, light and sound wood, free from knots and other

defects, is employed. It must be strong, and yet pliable and easily cloven; it is split with a special instrument, termed a divider (Fig. 337), in the radial direction, so that the silver-grain is visible on the broad surface of the staves, as the wood is least permeable in the direction at right angles to this. Whether, or not, wine leaks out of casks appears to depend

on the size of the pores, for it finds its way into the anatomical wood-vessels and oozes out at the ends of the staves.

In the preparation of staves, an oak stem is cut first into suitable lengths, which are then split in halves by means of a wedge. Each half-log is split further (Fig. 338) into three or four sectors; after the core and sapwood have been removed, these are split tangentially into pieces as wide as the staves by means of the divider driven by a wooden mallet. These pieces are fitted into a stove-maker's bench, composed of the fork of a tree (Fig. 339) resting on three stakes driven into the ground; then they are split radially into staves, and trimmed smooth by means of the shave (Fig. 340).

In Germany, the staves also are partly dressed into a curved shape with the adze, but in France they are bent into shape. The dimensions of the staves vary considerably, according to the demands of the trade. The broadest pieces are required for heading vats, and can be taken only from large trees, which soon will be extinct in Germany. The Polish staves, which are exported from North Germany to England, France, Spain, etc., are classified as follows:—

| Class. | Length. | Remarks. |
|------------------------|----------------------------|---|
| Pipe-staves | 5 ft. 2 in. to 5 ft. 4 in. | — |
| Hogshead-staves | 4 ft. 2 in. to 4 ft. 4 in. | 3 pieces equivalent to two pipe-staves. |
| Barrel-staves | 3 ft. 2 in. to 3 ft. 4 in. | 2 pieces equivalent to one pipe-stave. |
| Head-pieces | 2 ft. 2 in. to 2 ft. 4 in. | 4 pieces equivalent to one pipe-stave. |

There is a very large demand for staves for the wine and beer trades; they are exported from the Baltic, Fiume and Trieste, and from North America. The best staves come from Croatia, Slavonia, Hungary, and Bosnia, which countries produced about 26,000,000 staves in the two years 1891 and 1892. The Bosnian staves are worked more easily, and therefore are preferred to those from Slavonia. Oakwood from those countries is sound and heavy, and the markets for it are Fiume and Trieste for France and England, and Vienna

for Germany, the best staves going to France. These are made as shown in Fig. 341, from the best oak trees measuring (without sapwood) 22 inches in diameter.

In the trade, the staves are sold in lots each sufficient to make up into a cask of different dimensions, or for France, in hundreds.

The import of staves (*Quercus alba*) from America is increasing steadily at Bordeaux, Liverpool, Hamburg, etc., and is reducing the price of European wood.

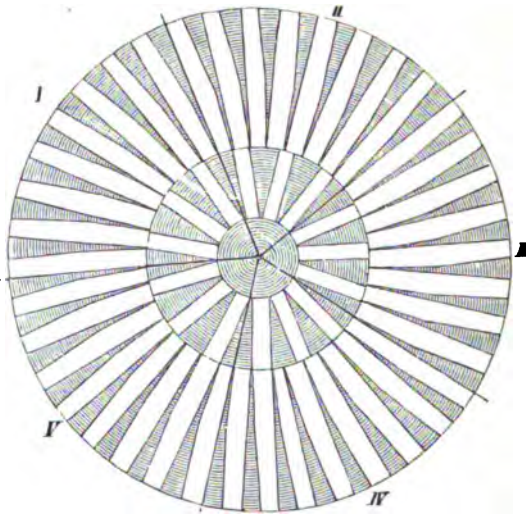

Fig. 341.—Staves shown in a cross-section of oak.

The waste of wood in making staves varies from 30 to 50 per cent.

After rough staves have left the forest they require further trimming and shaping by the hand of the cooper, and must be allowed to season in piles in the open for several years before they are fit to make serviceable casks. If, however, they are steeped in water when quite green and then dried carefully, they may be made into casks two years after leaving the forest.

Machines are used in England for making casks, and the latter are much more regular and of better appearance than those made by hand: it is only questionable whether casks

made of sawn staves are as durable as those made of split ones. In other countries machines are used no longer for cask-making, as they do not exclude subsequent manual labour in finishing the casks. It is stated that, in America, beer-barrels can be made of papier-mâché, which material for some time has been used for oil-barrels.

2. *Slack Barrels.*

Slack Barrels are used for non-spirituous liquids, etc., such as those used for the transport of herrings and other sea-fish, for living animals, for oil, bathing- and water-tubs, malting-vats, milk-pails and a number of other articles.

Herring-barrels were made formerly of inferior oakwood, but more recently of beech, birch, alder, red pine and aspen-wood. Large malting-vats, and other vats used in brewing, are made of oakwood. Oil and petroleum casks are made chiefly of beechwood, but also of oak and chestnut-wood. Other slack barrels are made almost exclusively of coniferous wood, only smaller drinking-vessels being made of maple, pear and cherry-wood, or in preference, of juniper or Cembran pinewood.

In splitting wood for staves for slack barrels methods are followed similar to those already described; the staves, however, are split usually along the annual rings, or made of good sawn material. Freedom from knots, and straight fibre, are here also the first conditions of suitability.

3. *Barrels for Dry Goods.*

Dry Goods Barrels are employed for storing and transport of all kinds of wares, such as salt, colours, cement, gypsum, sugar, currants, figs, butter, lard, chemical preparations, etc., and are made usually of coniferous wood. Staves for these barrels are seldom split, but are usually sawn pieces, $\frac{1}{2}$ inch thick, 2 to 5 inches broad and varying in length; poles, 4 to 4 $\frac{1}{2}$ inches in diameter at height of chest are used. Small-sized beech logs are used in Hungary and North Germany for barrels to contain currants, flour, and butter.

Barrels for dry goods are made chiefly in factories, and

there are large factories at Münden, Hanover, etc., for making margarine barrels. Smaller barrels are made of papier-mâché with wooden headings.

4. *Barrel-Hoops.*

Hoops for barrels are nowadays made increasingly of iron, but a large quantity of wooden hooping is still used. Coppice poles of oak, chestnut, birch and hazel and in America of hickory are used, also of willows for the smaller casks. They should be felled before the leaves are out. The coppice-shoots are cut with billhooks, trimmed of all twigs and knots, and then split in half. When green they can be bent easily to the requisite shape, but if dry, must be soaked first in water. In the case of slack barrels, the hoops are made chiefly of pieces of the stem of ash, spruce, or willow, 2 inches broad, and $\frac{1}{3}$ rd to $\frac{2}{3}$ rds of an inch thick. They are cut smooth with a knife, plunged into boiling water and bent over a round piece of wood.

SECTION XI.—SUNDRY USES OF SPLIT WOOD.

Some other articles besides casks and barrels are made of split wood, or of wood treated in a somewhat similar manner.

1. *Shingles for Roofing or to Cover Walls.*

Shingles are used either for roofs, or to cover masonry or cement walls, which otherwise do not exclude atmospheric moisture sufficiently. The most durable shingles are made of oak or larch, but owing to the abundance of spruce and Scots pine, wood of these species chiefly is used, and less frequently silver-fir wood; beech and aspen also are employed sometimes. The butts to be split must contain sound, light, and straight-grained wood without knots, and, therefore, chiefly the lower part of stems is employed. Wood of inferior grain, and less fissile may, however, be split by means of machines.

Shingles are prepared of very different sizes, according to the manner in which they are to be used. Roofs are covered usually with shingles three deep, *i. e.*, only a third part of each shingle being exposed (Fig. 342), and such roofs are very durable

and water-tight. Shingles used in this way are from 16 to 24 inches long, 8 to 10 inches broad, and from $\frac{3}{4}$ inch down to $\frac{1}{2}$ inch thick. In many countries they are so thin at one end as to be semi-transparent, especially in the case of larch shingles. Another kind of roofing (Legdächer) is employed frequently in Alpine districts, the shingles being from 30 to 40 inches long, and 8 to 12 inches broad. They overlap one another, and are fastened down by nailing split laths over them. In the case of tiled roofs, thin laths, 12 to 14 inches long and 2 to 3 inches broad, are placed wherever one tile is superposed over another.

Shingles are split radially from the butts, and the sectors thus obtained are continually split until pieces of the right dimensions have been secured; they are

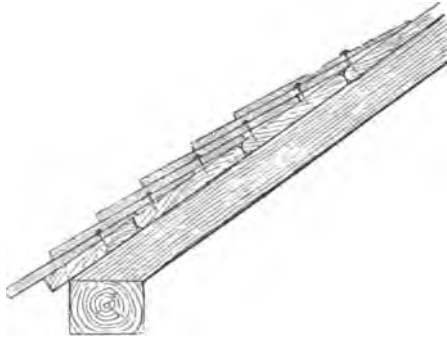

Fig. 342.—Position of shingles on a roof.

then made smooth. As the central portion of the butts cannot be used for shingles, there is a loss of 35 to 40 per cent. of wood in making them, and even more. Machines have been invented for making shingles, that by Gangloff* being the best known; thus a man and boy can make 700 shingles in a day, and wood of inferior quality may be utilised. Shingles stained black or red, the better to resist the weather, are prepared in Sweden. Fireproof shingles also are employed. In America, Weymouth pine, thuya, juniper, taxodium, sequoia, sugar-pine and Douglas-fir are used.

[In the Western Himalayas, deodar, and other conifers are used for shingles, the former wood being extremely durable.—Tr.]

2. *Wood for Oars and Rudders.*

Large quantities of wood are used for making rudders and oars. Ashwood is best, but much oak and beech also are used.

* Forst. u. Jagdzeitung, 1872, p. 312.

The pieces used for the purpose are 6 to 15 feet long, 4 to 5 inches broad at the flat end, and $2\frac{1}{2}$ inches to 3 inches square at the other end.

Large spars also, to stretch the large nets used by English fishing-boats, may be included here. The wood used is in round or split pieces of slender ash-stems 24 to 30 feet long, and 7 to 8 inches in diameter at the top. Oars for light river boats are made of split sprucewood of best quality.

3. *Broad split Pieces.*

Thin pieces of wood are used for making boxes, sheaths for swords or knives, by the bookbinder, shoemaker, etc.; they are chiefly of coniferous wood (spruce), but also wood of beech, aspen, and birch is used. They are split out of butts, or straight-fibred split billets. These pieces are made by planing-machines worked by water-power, the planes being fixed and the wood pushed against them. Sapwood of beech is split into sheathes for swords and hunting knives.

Wood-Tapestry of the thickness of ordinary paper is used for coating the walls of rooms, up to three feet broad and 60 to 100 feet long, it is prepared from the wood of all species of trees. This is obtained by supporting the butt on a special kind of turning-lathe, and revolving it against a blade which is constantly pressed further forwards as it peels off the periphery of the butt. The same machine may be used for making veneer.

Straight-grained sprucewood also is split and used for making **plaited wooden baskets**, which are exported in large numbers from the Erzgebirge. The wood of aspen and lime also is used similarly. In order to prepare the wood for this purpose, it is soaked thoroughly in water and cut into bars, which are split into thin pieces along each of the annual rings. These pieces are extremely flexible.

Sprucewood is used also for **sieve-frames** and **cheese-moulds**, the wood for which is separated from ordinary split billets with the cooper's divider and afterwards planed with the same instrument. These pieces are made in different dimensions, their length being measured in hands (4 inches): thus there

are pieces of 4, 6, 8, etc., up to 24 hands, the breadth varying with the length between $2\frac{1}{2}$ and 8 inches. Wood must be used green for this purpose, the preparation of the pieces and subsequent bending thus being facilitated.

The pieces are then steamed and bent on simple frames, and tied into bundles of 10 to 15 pieces for sale. Wooden rings are made wider than the frames, but only $\frac{1}{3}$ rd of their height. The bottoms of the sieves are fixed between the frame and the ring.

The sides of measures for fruit or dry goods, and of drums, and other round articles, are split radially from billets of beech, sallow or oak, from which all defective heartwood and the younger zones of sapwood have been excluded. They are split with the divider, worked smooth on the cooper's bench, steamed and bent around frames. They are then sorted, and sold in assortments like sieve-frames. Young stems of ash also are used for this purpose, as well as for making tennis racquets.

The band-box maker uses chiefly spruce and silver-fir wood, less frequently larch, sycamore, and sallow wood. Wood for drums and for boxes shaped like drums to contain fruit, etc., are made of oak and beech, cut radially out of blocks. They are fastened by rings of split wood. Butts of straight-grained wood are cut into the proper lengths, and split into from 4 to 6 billets; after these are thoroughly dried, they are split gradually by successive bisection into pieces of the required dimensions.

Then the pieces are planed carefully, softened in boiling water, fastened over frames, and when thoroughly dried are fastened together by wooden bands. The bottoms and lids for each box are made in a similar manner.

Oblong lucifer match-boxes are made chiefly at Jönköping of aspen-wood by means of machines, which cut out a piece large enough for a box, and press dents into the wood wherever a side has to be bent inwards. In the absence of aspen-wood, wood of lime or poplar is used in Germany for these boxes.

Strainers for beer and vinegar are made of hazel, and in its absence of hornbeam and beech. The wood is steeped in water till it has lost its colour.

4. *Wood-Wool.*

Wood-Wool may be mentioned here, which is made from even-grained wood, chiefly coniferous, though any species of wood may be used, in round pieces 1 to 2 feet long, and is used instead of hay, seaweed, etc., as packing material; for stuffing chairs, and other furniture; as stable litter; for preserving ice, and in surgery, etc. Also it is made into ropes.

Villeroy, in Shramberg, compresses very fine wood-wool under high-pressure into a sort of papier-mâché, which is very durable and is used for rules, carvings, ornaments, etc.

5. *Round Pieces of Wood.*

Slender pieces of wood are used for making handles for paint-brushes and pens, flower-sticks, etc., also wooden thread for making lucifer-matches and other articles. Fissile straight-grained sprucewood is used for these purposes. The pieces used for paint-brush handles, penholders and flower-sticks are in section either round, semi-circular, oval, or quadrangular, and of various lengths up to 5 feet. They are prepared by machines from wood in the rough. Grasenu, in Bavaria, is one of the chief seats of this industry.

[Beechwood is made similarly into round pieces from the size of a pencil to that of a flag-staff, and also into conical spigots, at Villers Cotterêts, in France, square pieces being pushed through a system of revolving planes, and coming out round.—Tr.]

Wooden thread is now prepared on a large scale, either in round pieces of sprucewood 8 to 30 feet long, or in short pieces, used for lucifer-matches in Germany and Sweden.

The round pieces, usually $\frac{1}{2}$ th of an inch (2 mm.) thick, are made only from the finest grained sprucewood, and thus the refuse of musical instrument wood may be utilised. They used to be made by manual labour with Romer's plane, which, instead of an ordinary cutting blade, has a blade with a number of funnel-shaped grooves, each of which cuts-out a cylindrical thread. After a layer of thread had been planed away, the wood was planed smooth by means of an ordinary plane, and then a fresh layer of threads removed.

At present manual labour has been replaced by machinery constructed on the principle of Romer's plane. The threads are then woven with stout twine into blinds, floor-coverings, table-covers, etc., and in tropical countries are specially useful for chinks, which, hanging before doors and windows, allow sufficient ventilation, while excluding the glare of sunlight and insects.

The short pieces used for lucifer-matches are made from the most various woods, especially those of spruce, Scots pine, silver-fir and aspen. They are prepared in factories according to three different methods. The oldest method, and that still most usual in Germany, is by means of Romer's plane, which in this case is perforated by twenty-five to thirty little cutting tubes, one above the other, through which the wood is forced by the workmen. The serviceable pieces are separated by machinery from the unserviceable pieces, and placed 500 together in boxes, which are fastened by rings into large bundles containing several thousand pieces; a workman can prepare 200,000 pieces in a day.

Another method is employed in Sweden, only aspen-wood being thus used. The round piece of rough wood, $1\frac{1}{2}$ feet long, is softened in water and fixed between the points of a lathe, and the wood is then turned against a blade which peels-off from it a long piece $1\frac{1}{2}$ feet broad, of the thickness of a match. This is then cut and split by machines into separate pieces, each the size of a match. The Jönköping factories alone used up, in 1883, 280,000 cubic feet of Russian aspen-wood for this purpose.

Pieces with a quadrilateral section are prepared after a third method, machines similar to those in use for wood-wool being employed.

The manufacture of lucifer-matches is steadily consuming more and more wood; there are factories, which for matches and match-boxes, consume 200,000 to 300,000 stacked cubic feet of wood annually. Thirty-five stacked cubic feet of wood will yield 2,000,000 lucifer matches 2 inches long, weighing $3\frac{1}{2}$ cwt. The yearly requirements of Europe in this respect are estimated at more than 14,000,000 cubic feet of wood.

6. *Trenails.*

Trenails are wooden pegs of various sizes, the largest being used in shipbuilding and smaller sizes by the cabinet-maker and joiner, for fastening pieces of wood together; the smallest kinds are used by shoemakers. Ships' trenails are in lengths of 4, 8, 16, 28 inches, $1\frac{1}{2}$ to 3 inches thick; they are made of robinia, ash and mulberry-wood. Thirty-five stacked cubic feet yield on the average 200 trenails. Trenails used by joiners and cabinet-makers are made of the wood of oak, fruit-trees, beech, and even of coniferous wood, besides that of robinia and ash. Shoemakers' pegs are made of birch, hornbeam and sycamore.

The largest kinds of trenails are made by machinery as follows:—A round piece of wood is cut to the length of the nails, and then placed on a sliding frame, which forces it against the cutting-blade. It is thus split in one direction, and then turned through an angle of 90 deg. and split again. The split pieces are then pointed conically by machines.

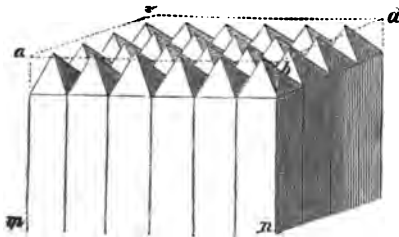

Fig. 343.

Shoemakers' pegs are made similarly, only here, as in Fig. 343, the points are made by means of planes running first along *a b*, and then along *a c*. The pieces are then split vertically (*a m*). There are factories in Silesia where annually 35,000 cubic feet of wood are made into shoemakers' pegs.

Large numbers of wooden toothpicks are made at Weissenfels and other places, of soft, white wood, chiefly willow.

[6,000 to 12,000 trenails are made daily at a factory in Walsall, besides 6,000 to 8,000 railway-keys. Large straight oak logs are used.—Tr.]

7. *Lead-Pencils.*

The best wood for lead-pencils is the so-called cedar (*Juniperus virginiana*, L., and *J. bermudiana*, L.), but inferior

pencils are made of the wood of lime, spruce, Cembra pine and poplar. The wood is partly split and partly planed into shape.

8. *Wood for String Musical Instruments.*

Split wood is used for making violins, violoncellos and other string-instruments. As steamed woods more or less curved and pressed into shape are required, only split wood, but not sawn wood, can stand the strain. The fronts and backs of the instruments are made of spruce and silver-fir wood, and their sides of sycamore. As regards fine zones and uniform structure, wood of even superior quality to that used for pianofortes is required. The zones in the wood for violins should not exceed 1 to 2 mm. ($\frac{1}{25}$ to $\frac{1}{12}$ inch); for double-basses and violoncellos it may be coarser-textured, 2 to 4 mm. ($\frac{1}{12}$ to $\frac{1}{8}$ inch).

The higher the key, the finer the woody zones should be. This valuable wood is steadily becoming scarce. Up to the present it has been obtained from selection forests, in which the suitable trees are found disseminated. It is rare that an entire stem can be used for making musical instruments, only the fine-zoned external parts of it being suitable. These pieces are imported in split sector-shaped pieces, from which the core has been removed, in lengths of 16 to 30 inches for violins, or of 40 to 60 inches for the larger string instruments. Grasenau (in the Bavarian Forest), Mittenwald (in the Bavarian Alps), and Markneukirschen (in Saxony) are the best known markets for these goods.

SECTION XII.—WINDOW-FRAMES.

Glaziers formerly used chiefly oakwood for window-frames; less frequently, wood of sweet chestnut, elm, larch and Scots pine. More recently, in large towns, the better kinds of Scots pinewood [or teak.—Tr.] have replaced oak for this purpose. The glazier requires oakwood of similar quality to that used by the cooper; generally it is sawn, with a nearly square section, or is taken from the refuse wood after splitting staves, or is split from billets. Sawn oak planks are used for

the larger windows. The advantage of split wood for this purpose is that it warps less than sawn wood. Coniferous window-frame wood comes into the market ready prepared by machinery. Iron is steadily replacing wood for window-frames, especially in windows of shops and other large buildings.

SECTION XIII.—WOOD-CARVING.

The wood-carver is represented by a whole class of artizans who use a number of chisel-like tools, especially in the finish of their products. The following classification of these wares is attempted :—

1. *Coarse Wood-Carving.*

All sorts of bowls, plates, platters; corn, meal, malt, and bakers' shovels; kitchen-rollers, milliners' blocks, and stands for shops, milk-ladles, wooden spoons, wooden shoes and heels, shoemakers' lasts, saddle-trees, etc. Beechwood chiefly is

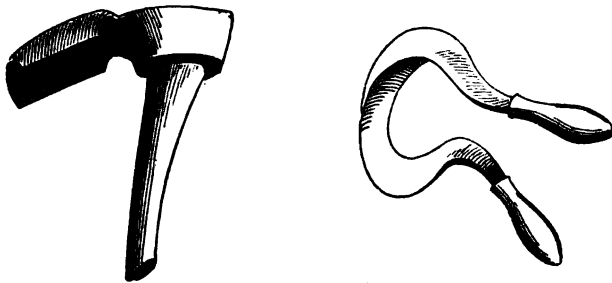

Figs. 344 and 345.—Instruments for making sabots.

used for these articles and sycamore-wood for cooking apparatus; wood of birch, aspen, lime and poplar also are used, and boxwood for the finest Russian wares.

Chiefly short wooden butts are used, which for the larger bowls, platters, etc., should be 3 feet and more in diameter, and, on account of their size, are becoming scarce. For smaller articles, and especially sabots, or wooden shoes, the better sorts of timber are required. All the timber used should split easily, be perfectly sound and free from defects and knots.

As the finished articles must be, above all, safe from warping

and sufficiently strong, the cuts should be along their lines of greatest extension. The butt is therefore split into from four to six sectors, from which the core and bark are removed and the shape roughly hewn-out with an adze. The further finish is given to the articles with special instruments, which are bent according to its shape, and of which Figs. 344 and 345 represent general types.

The remarkable progress which has been made recently in wood-working machines favours the idea that handwork on rough wood-carving will become in time more and more replaced by machinery. The turning-lathe is already largely used for round articles, whilst machines have been invented by which almost any shape may be given to wooden articles.

Wooden shoes (*sabôts*) are made by hand, of the wood of beech, alder, birch, hornbeam, walnut or poplar, the split pieces first being trimmed roughly into shape by a short hatchet and then finished with various curved instruments. Trees 2 feet to 2½ feet in diameter at height of chest are preferred for this purpose. In order to give the shoes a dark colour and preserve them from splitting whilst being gradually dried, they are smoked. The finer kinds are made of poplar, or willow, and blackened. The Département of Lozère, in France, alone produces 600,000 pairs of wooden shoes yearly.

Wooden soles (*galoches*) for leather boots, and wooden pattens and clogs, are made largely in France and Saxony by machinery. Clogs are made in Britain of alder. Shoemakers' lasts are made chiefly of hornbeam-wood, and failing that of beech or sycamore; there are large factories of these articles in Bohemia and Saxony, in which machinery is used. [Wooden heels of women's boots are made extensively in Normandy.—Tr.]

Broom-heads and brush-backs are made chiefly of beech and cherry-wood. They are made chiefly at Globenstein in the Erz mountains, at Esslingen, and at Todtenau in the Black Forest, where £25,000 to £30,000 worth of broomheads are made yearly. [There is a small factory for brush-backs at Villers Cotterêts.—Tr.]

Wood is used mostly green for rough wood-carving, as it is then easier to work.

2. *Gun-stocks, Wind-Instruments, etc.*

For **gun-stocks** and **pistol-stocks**, wavy wood of walnut, maple, birch, elm and sycamore is used, chiefly from the lower part of the stem and the roots. Beechwood also is used for inferior muskets. [American walnut-trees were sold at £40 each for this purpose in 1898 (Laslett).—Tr.] The various **wind-instruments**, clarinet, flute, fife, etc., are made from boxwood, and wood of ebony, birch, service-tree, maple, and grenadil; **wooden pipes** from bruyère (*Erica arborea*, L.), alder, maple, birch and sycamore. All the wood used must first be dried, and again from time to time laid aside to dry during the making of the instruments, or it would soon warp. Klingental and Markneukirchen in the Erz mountains are the chief places for the manufacture of flutes, etc.

3. *Children's Toys.*

Enormous numbers of these pretty articles are made by dovetailing little cut pieces of wood, also by the turning-lathe and by carving. Sprucewood chiefly is used, between 60 to 70 per cent. of the whole, also wood of lime, oak, aspen, birch and alder. Regarding the importance of this trade, it is noted that at Olbernhau in the Erz mountains 1,000 to 1,500 tons, worth £35,000, are made yearly. The work is done by manual labour and by machinery; and there are factories where only one special toy is made (for instance, toy-guns).

Little animals which are afterwards painted to imitate nature, are, in the Erz mountains, split-out from rings of sprucewood, which have been turned on a lathe, so that the animals are roughly formed along their radii.

This vast industry, of which Germany had for many years a monopoly for the whole world, has now taken root in other countries, under protective duties, and toys are now exported largely from America.

4. *Artistic Wood-Carving.*

The art of wood-carving attained its highest perfection in the 14th and 15th centuries A.D., but after a long slumber has revived recently. Moderately hard, fine and homogeneous

woods are most suitable for this purpose, in which neither the annual rings nor the medullary rays are too prominent.

Limewood is best, and then comes the wood of sycamore, horse-chestnut, walnut and fruit-trees. Oakwood is much used for carving, mountain and Cembran pinewood for inferior work. Besides carvings in which human figures and beasts are imitated, ornamental furniture is made largely, also frames for mirrors, clock-cases, etc.

Numerous smaller articles, such as ash-trays, salad-spoons and forks, paper-weights, napkin-rings, photograph-frames, etc., are produced in large numbers. There are now places, such as Oberammergau, Berchtesgaden and Salzburg, where wood-carving, fostered by schools of art, forms the chief occupation of the people.

[Fine wood-carving has long been a speciality in India, and very valuable art-furniture is now made in the Punjab, Burma, and other provinces.—Tr.]

A special form of wood-carving consists in the large wooden type used for advertisements, notices, etc. Pear and apple-wood, sycamore and boxwood are used chiefly, and this industry has its principal seat in Switzerland.

[Wood-engravers use almost exclusively boxwood for their plates to illustrate books and newspapers, and this wood is steadily becoming rarer, selling at from £20 to £30 a ton in London. There is a considerable area of boxwood forest in the Himalayas, the protection of which is highly advisable; the wood is used chiefly for making combs.—Tr.]

SECTION XIV.—TURNERY.

The turner employs hard, homogeneous wood capable of being polished, and besides using many exotic woods, such as box, ebony, etc., prefers the wood of beech, sycamore, horn-beam, service-tree, birch, aspen, yew, walnut and fruit-trees. Chiefly split pieces of wood are used and the turner purchases round butts or split billets.

Although the demands the turner makes on the forest are only small, it is interesting to give an account of some of his wares. Large wooden screws for wine or oil-presses are made of the wood of pear, apple or hornbeam; for mangles

for pressing linen, of the same species, and also of sycamore, service-tree and beech. Turned legs and other pieces for ornamental furniture are chiefly of walnut-wood. **Hat-moulds** are made of lime or alder-wood; **skittles** of hornbeam, pear and service-wood; bowls, of *lignum-vitæ* (*Guaiacum*); **shuttles**, of boxwood; reels for thread, of birch and aspen-wood; **spools**, chiefly of birch [of which 5,000,000 feet of spool-bars are imported annually into Britain from America; birch, beech and sycamore grown in Britain also are used.—Tr.]; **pipe-stems**, of apple, cherry, plum, maple, etc.; **walking-sticks** and umbrella-handles of oak or ash coppice-shoots, white-thorn, vine-stock, dog-wood, fruit-trees, and many exotic woods such as those of olive, greenheart, etc.; **cask-taps**, of pear, apple, yew, larch and Cembran pine; **bungs** are made of split oak-wood and inferior sprucewood.

Wherever these articles are made in factories, the demand on neighbouring forests may be considerable; as, for instance, for spools, wooden buttons, bungs, handles for tools, etc.

SECTION XV.—PLAITED WOOD-WORK.

This section may be divided into **basket-work**, and **plaited wood-work** properly so called.

1. *Basket-Work.*

The basket-maker prepares wares of all shapes and dimensions, from coarse hampers, fish-traps, etc., to the finest kinds of baskets. The materials used are osiers, chiefly of *Salix viminalis*, *purpurea*, *rubra*, *amygdalina*, *triandra*, *Lambertiana*, *pruinosa*, etc., also shoots of birch and of climbing plants, and the finer roots of Scots pine, mountain-pine or larch. The best osiers are thin yearling shoots, free from branches, about six to eight feet long, with white, soft wood; one or other kind of willow is preferred, according to locality, but *S. viminalis* and *amygdalina*, *purpurea* and *rubra* are the best esteemed.

For superior basket-work, the osiers are peeled, which is done immediately after they have been cut, when the sap is rising.

The osiers may, however, be peeled, if they are plunged into water at a temperature of from 100 to 120° Fahr., without

becoming impaired in colour or texture. After being peeled, the willows should be dried thoroughly by exposure to the sun and air, or they will turn bluish and become brittle. They must be steeped in water when used, in order to recover their flexibility. For rough hampers and fish-traps the coarser osiers up to $\frac{1}{2}$ inch thick are used, unpeeled, but freshly cut.

Coarser baskets are made from unsplit osiers, the thin ends being cut-off, so that the thickness of the pieces used may be fairly uniform. Finer basket-work is made of split osiers. These fine baskets are made over caoutchouc moulds. Spanish cane from the Philippine Islands, and split bamboo, make the finest basket-work.

In vine districts a large quantity of osiers are used as withes for fastening the vines to their supports. *S. viminalis* and *S. alba* are used chiefly.

2. Wood-plaiting.

Wood-plaiting is the most highly artificial employment of wooden threads, which are woven on a frame into various articles. The simplest of these are sieves, mats and carpets made of wooden threads at Klein-Cerma, in Bohemia. Silver-fir fibres are employed chiefly in strands 16 to 24 inches long, spun into threads and woven into carpets.

The finer kinds of goods are formed of woven material, which is afterwards bent over moulds into hats, purses, cigar-cases, table-covers, blinds, etc. Alt- and Neu-Ehrenberg in Northern Bohemia are the chief seats of this industry, and only aspenwood is used, the wood being imported chiefly from Poland, and kept in pits under water till required.

The wood-fibres are prepared by the use of planes with numerous longitudinal groovings, and from them the material is woven on looms in pieces $2\frac{1}{2}$ to 3 feet long and 2 feet broad. The threads are sometimes coloured.

Another way of making textile fibres from wood is to boil pieces of sprucewood, 8 or 9 inches long, with gypsum, as in cellulose-factories, so that the wood becomes resolved into its ultimate fibres. These fibres may then, like cotton or hemp, be spun into threads and twisted into ropes. In California this material is used on a large scale for various purposes.

SECTION XVI.—WOOD FOR AGRICULTURAL PURPOSES.

A considerable amount of wood is used in agricultural industries. These products have one character in common, being used more or less in the rough, or at least without any elaborate preparation. The following comprise the chief classes:—

Pea-sticks, consisting of twigs 1 to 3 years old from various broadleaved species, especially beech and birch, are the tops and branches of poles and trees that are cut off after fellings, in lengths from 2 to 4 feet.

Bean-sticks are used for scarlet-runners and other climbing beans; they are poles 8 to 10 feet long, and up to about $1\frac{1}{2}$ inches thick at the base. Coniferous saplings, or straight coppice-shoots of broadleaved species, are employed chiefly for this purpose.

Stakes are intermediate in thickness between bean-sticks and hop-poles, and are used for all kinds of purposes, chiefly to fill gaps in hedges and fences. They are generally coniferous saplings and smaller poles. Stakes are used also for tightening chains and ropes, in lading timber and firewood on to carts. Saplings and small poles of various lengths, of oak, ash, birch, beech, etc., are employed.

Hop-poles, for use in hop-gardens; chiefly light, straight and slender coniferous poles are employed. [Sweet chestnut coppice also yields excellent hop-poles, and has been grown largely and profitably in Kent and elsewhere for the purpose.—Tr.] The introduction of steel-wire between wooden supports has replaced hop-poles in many localities, and reduced considerably the demand for the latter.

Hop-poles are usually placed in 4 to 6 classes, according to their dimensions, being from 16 to 40 feet long, and from $2\frac{1}{2}$ to 5 inches thick at the base. Generally they are barked in order to render them more durable.

Tree-stakes, to support freshly-planted orchard trees in Germany usually consist of coniferous poles cut into lengths of 10 to 20 feet; also old (red) aspen-wood, robinia, and other broadleaved trees (ash, etc.) are employed for this purpose.

[**Hurdles and crate-wood.**—Much split ash, oak, pollard willow shoots and other coppice-wood is required in Britain for hurdles, and for crates used in packing machinery, crockery, etc. Crate-wood is in great demand for the Potteries.—Tr.]

Tree-props, which are used to prop up the boughs of orchard trees when heavily laden with fruit, are usually of the same dimensions as small or middling-sized hop-poles, and are made from poles of conifers, also of beech, oaks and other trees, several stumps of branches being left at their tops to serve as forks and support the laden branches. Props for drying clothes are similar.

Vine-stakes, which are placed in the ground close to vines, and to which the latter are tied, consist usually of split oak or coniferous wood, 6 to 8 feet long, and $1\frac{1}{2}$ to 3 inches square. In Alsace, vine-stakes are split from sweet chestnut and robinia stool-shoots 10 to 12 feet long; they are far more durable than oak-stakes. In France, vine-stakes are made even of aspen and willows. Impregnated spruce poles are replacing broadleaved wood, especially from Switzerland.

Wherever, as in parts of the Palatinate, the vines are grown very low, and spread more horizontally than vertically, the stakes are left in the ground over winter, and only oak, sweet chestnut and robinia-wood are found serviceable. In this case, horizontal pieces or bars of wood are nailed across from one stake to another, the latter being placed into the ground vertically. The stakes are thick split pieces 4 to 6 feet long, and the bars split laths 10 to 14 feet long, which are split off straight-grained stems by means of a wedge or divider. Sometimes they are replaced by steel-wire.

Wooden Park Palings.—These are employed round gardens and parks, and especially in Alpine pastures, and are made by splitting round logs 4 to 6 feet long. Inferior kinds of wood are used sawn and generally creosoted. They may be driven directly into the ground side by side. [In Britain, they are generally nailed to strong post-and-rail supports, and kept entirely above ground, the lower part of the fence being formed by a plank placed horizontally from post to post. Deer-parks require the strongest fencing, and split oak and sweet chestnut, or sawn larch or Scots pinewood are used chiefly.

Cheap palings are made of chestnut laths bound together with wire by a machine.—Tr.]

Withes for fastening faggots, bundles of corn, oak-bark, hemp, etc., are made of coppice-shoots of hazels, willows, and different shrubs; sometimes oak and beech saplings are stolen for the purpose.

Brooms are made usually of young shoots and twigs of birch trees, and should be cut before the foliage has appeared. Vigorous birch trees afford the best shoots for brooms. Brooms are made also of broom, *Genista*, peeled osiers, etc.

[In India large quantities of prickly bushes are used annually for making temporary dead fences round the crops in the dry season, and are used for fuel, or left to rot, when the cattle come into the fields to graze on the stubble after the harvest in April.—Tr.]

SECTION XVII.—REFUSE WOOD.

The refuse wood, after sawing or splitting has been effected, and the bark, are cut by the circular saw into convenient lengths, fastened into bundles and sold as kindling material. Wood-shavings serve a similar purpose, but attempts have been made to press them into briquets mixed with cement to form Xylolith.

Sawdust has many uses, it is burned in specially-made furnaces to supply heating-power to steam-engines. Sawdust and cellulose acted on by dilute nitric acid and boiling solution of common salt are used for fodder (Wendenburg's system). It is used as litter in stalls and wet places; to place in layers between seeds in winter; also between rows of seedlings in forest nurseries as a protection against frost; as a packing for fragile goods; with cement, soluble glass and gypsum, it is converted into xylolith or papyrolith; mixed with chromium gelatine and immersed in boiling oil it produces a substance resembling gum. Sawdust is used for making oxalic acid and methyl-alcohol; when heated it is pressed into briquets, nearly as serviceable as coal, or if soaked and pressed it is easily kindled (Hugendudel system); when steamed, it may be pressed into permanent shapes.

Sub-division II.—Firewood.

The material used for fuel consists of split billets of coniferous wood, resinous pieces of spruce or pine, birch-bark, wood-shavings, brushwood of any kind. Briquets of pressed peat saturated by easily combustible substances may be substituted.

Firewood is burned directly for heating apartments, or for cooking food, washing, drying, etc. Hardwoods, which give out a more lasting, uniform heat than softwoods, are preferred to the latter for the above household purposes. For boiling food or heating boilers, as in kitchens, hard dense woods are preferred; for baking or roasting, when a quick intense heat is required, porous softwood or charcoal is preferable. It is not always possible, however, to obtain the best material, and wood of all kinds is used for both purposes. The Danish Forestry Society has constructed a permanent wood-furnace: Reek's furnace at Copenhagen is the best; 18 lbs. of wood, filled in three times, burns for 36 hours.

Firewood is still employed in factories, which may be classified according as they require **hardwoods**, as in soap-making, laundries, and all factories employing boilers; or **softwoods**, producing a quickly radiating, intense heat, as in bakeries, potteries, brick-kilns, lime-kilns, etc.; finally, **charcoal**, the heat of which is not only quick and intense, but also very enduring, as for the work of locksmiths, blacksmiths, glass-makers, etc.

The utilization of **dead firewood** also may be considered here. This consists of all dry branches and twigs lying on the ground, that have been broken from the trees either by the natural clearing process of the woods, or by wind or snow; its reduction into small pieces, without the use of implements, can be effected by breaking it simply by hand or across the knee. Such a strict definition of fallen firewood cannot, however, be considered as universal; its inexactness is apparent for many localities where dry branchwood is included that is still attached to the trees, from which it may be broken by hand or dragged down by a hook: in other places are included small pieces of wood and roots, that are still reproductive and have not been dug up, as well as all refuse wood

left unsold on the filling-areas ; finally, in still other districts the collector of dead wood is permitted to cut down and appropriate dead standing saplings and poles. [It is absolutely necessary that for all forest-ranges a local definition of the meaning of dead firewood should be made and enforced strictly.—Tr.]

The collection of dead firewood is very simple: the wood is picked up from the ground and wherever the dry branches of standing trees are included, they are pulled down by iron hooks at the end of long poles, or men climb the trees and cut off the dead wood with an axe. The method of collection is not an indifferent matter to the forester. So long as dead wood lying on the ground only is collected, its removal is not injurious, but its harmless character is gone when hooks are used. Important as it is that trees should lose their dead branches in order to improve the value of their wood, it is, however, most hurtful to remove these branches in an injurious manner. It has been stated already (p. 135), that at the circular occlusion around the base of a dead branch a small depression exists, in which water accumulates and moisture persists for some time, so that at this place the branch rots quickly and eventually breaks off by its own weight, which has the greater effect the longer is the leverage of the branch. If such a stage of decomposition has not been reached, as in the case of all branches that have died only recently, the breakage of the branch by the hook leaves a little stump, which only in the course of years becomes occluded in the stem. **The hook should therefore be excluded from all woods that are not yet mature ;** it is certainly more injurious than the axe by which occasionally a suppressed but still green sapling may be cut. It would therefore be much better for the forest if the hook were replaced by the pruning tree-saw.

The yield of dead wood varies in quantity according to the definition of dead firewood. Whenever only refuse wood and dead stems are taken, it amounts to 12 to 15 per cent. of the volume of a crop. When the trees stand close together, it is greater than when they are far apart, is greater on good than on bad soil, it is greatest of all in pole-woods, when weaker poles are being suppressed.

The utilization of dead firewood is important in national economy, for usually its collection and removal is left gratuitously to poor men, women and children; in many forest districts, it forms a servitude on the forest.

As all fallen wood, if it remains in the forest, is a manure to the soil and renders it porous and well aerated, its utilization should be abandoned on poor soils, or on heavy, wet ones; but the increased danger from fire, especially on sandy soil in sunny, dry places, renders its removal there advisable.

Highly resinous pieces from the stumps of felled pines, and other coniferous trees are used as torches in mountainous countries, as in the Himalayas.

Sub-division III.—Utilization of living plants or of parts of plants.

The sale of living plants or of parts of plants has become so profitable to the forest-owner, especially near large towns, as to deserve mention.

1. **Plants with roots**, for plantations or parks. They are either reared in home-nurseries or purchased from professional nurserymen. They are classified according to their age and height, but it would be better if both age and height were specified, as then the quality of the plants could be estimated better. Exotic plants are expensive, partly owing to the high cost of the seed, partly on account of their beauty, and partly because the purchasers are unaware of the real cost of producing them.

2. **Plants without roots**. Christmas trees (sometimes rooted) are almost exclusively conifers, usually of spruce or silver-fir. In Franconia birches are used; they are cut at the beginning of September, placed in water, and kept in warm rooms, so that they are green on Christmas Day.

The height of Christmas trees varies from 3 to 16 feet, and their age from 5 to 20 years; plants grown in the open have the strongest branches and the best appearance. Mencke recommends fencing in areas near large towns for the growth of Christmas trees, planting them at the rate of 160 plants an acre, and selling them when twelve years old.

Suppressed stems of evergreen conifers with flat, scanty crowns are placed along the sides of roads in order to point out the roadway in times of heavy snowfall.

3. Small branches of all species of trees, but especially of conifers, serve as shelter to delicate plants against sun or frost, or for decorative purposes. Near towns the sale of such material that is pruned from open plantations is a productive source of revenue. They are sold by weight, in bundles, or by the cart-load. Holly, mistletoe, etc., are extensively used at Christmas.

Sub-division IV.—Woods arranged according to their Uses.

In the following abstract of the technical uses to which wood may be put, only its uses as timber are considered. The list first contains the European woods, and then the most serviceable foreign woods.

1. *Woods of Broadleaved Trees.*

Oakwood.—Used for superstructures, hydraulic works, bridges, ship and boat-building, gate-posts, mill-wheels, railway-sleepers, mining timber, joiners' work, cabinet-making; for wheelwrights' work, blocks, staves, bungs, sieve-frames, shingles, trenails, wood-carving, pianoforte-making, turnery, window-frames, park-palings, vine-stakes, hurdles, rungs for ladders, etc.

It should be noted that the fine-zoned, easily worked, softer wood of the sessile oak is preferred to that of pedunculate oak for all purposes making less demands on size, hardness, strength and durability. The latter is preferable for construction of all kinds, for staves, wheelwrights' work, split-wood, etc.

Ashwood.—For pillars, stamping hammers, wheelwrights' work, joinery implements, tool- and whip-handles, billiard-cues, racquets, hurdles, barrel-hoops, gymnastic apparatus, lance-shafts, rudders and oars, thatchwood for stacks. Figured ashwood is greatly in demand for furniture.

Elmwood.—Used by the furniture-maker, undertaker and turner, greatly in demand by the wheelwright; for butchers'

blocks and the inner lining of ships. [Elmwood, being tough, is used for boxes for tin-plates.—Tr.] Figured elmwood is much esteemed; the wood of the common elm is more valuable generally than that of the mountain elm.

Sweet chestnut.—Used occasionally in superstructures, also for furniture, gate-posts, park-palings, fences and hurdles, staves; makes excellent vine-stakes, hop-poles and hoops.

Sycamore and maple.—Preferred by the cabinet-maker for solid and veneered articles, parquetry, etc.; by the turner and carver, in cotton and jute mills for rollers and spools; for churns, musical instruments, gun-stocks, and ornamental whip-handles. Bird's-eye maple is very valuable.

Limewood.—For fine carving, founders' models; used under veneer, for wooden basket-work; in pianos and organs, wooden shoes, papier-mâché, etc.

Beechwood.—Joinery, for floors and staircases, in mills and mines (stamping-hammers), railway-sleepers, street-paving blocks, cabinet-making; for furniture, pianos, carpenters' benches, wheelwrights' work, slack barrels, agricultural implements, packing-cases, measures, sieve-frames; for coarse carved work, maltsters' shovels, wooden shoes, horse-collars, gun-stocks, broom-heads, brush-backs, plane-boxes, spigots, etc.

Hornbeam-wood.—Wheelwrights' work, in mills, machinery, turnery, shoemakers' pegs and lasts, plane-boxes, carpenters' benches, tool-handles, agricultural implements, skittles, etc.

Birchwood.—Joinery, furniture, wheelwrights' work, turnery, spools, bobbins, wood-carving, brushes, clogs, shoe-pegs, coarse carved wares, withes, brooms, etc. Figured birchwood much prized by cabinet-maker and carriage-builder.

Alderwood.—Used underground in mines, for covering damp places, water-conduits; largely used for cigar-boxes, clog-soles, broom-heads, toys; also for gunpowder.

Poplar.—Rafters and rails, slips for cargo, joinery and wheelwrights' work, packing-cases, coarse carving, matches, cigar-boxes, and papier-mâché. The white poplar, or Abele, also for superior wood-carving and in organs. Aspen for lucifer-matches and paper-pulp.

Willow.—Cricket-bats (*Salix alba-viridis*),* basket-work,

* E. B. Pratt, "Variations of *Salix alba*." Journal of Forestry, Oct., 1907.

clothes-pegs, withes, fascines; wood of tree-willows used in furniture under veneer, for packing-cases, hurdles, papier-mâché. [Being soft and tenacious is used as well as poplar for lining carts for carrying stones.—Tr.]

Robinia (False acacia).—Wheelwrights' wood, especially spokes, rungs, implements, joinery, trenails, vine-stakes, tool-handles and turnery.

Service-wood (*Pyrus torminalis*).—Used by turner and cabinet-maker, and for wood-carving. [*Pyrus Sorbus* yields very finely grained wood, used for set-squares, French curves, etc.—Tr.]

Rowan-wood (*Pyrus Aucuparia*).—Splendid wheelwrights' wood, on account of its great toughness.

Wild pear (*Pyrus communis*).—Highly esteemed for cabinet-making and turnery, for picture-frames, blocks for woodcuts. Figured wood equally prized with that of the cultivated pear and apple-tree for veneers.

Hazel.—Used for hoops, sieve-frames, also by the cabinet-maker; for holding chisels to cut iron plates.

Horse-chestnut.—Used by the turner and cabinet-maker and for fine wood-carving.

Wild Cherry (*Prunus Cerasus*, L.).—By the cabinet-maker, turner, and wheelwright. *P. Padus* for holding chisels.

Walnut.—Highly esteemed for furniture, veneer, gun-stocks, and for frames, wood-carving and turnery.

Laburnum (*Cytisus Laburnum* and *C. alpinum*).—Splendid wood for turning, or for furniture.

Boxwood, for wood-engraving and turnery, flutes, measures, shuttles. This wood is becoming rare owing to the absence of forestry in the Black Sea districts.

2. Coniferous Woods.

Spruce.—Superstructures of all kinds, in boats for fresh-water traffic. Sawn timber used by the joiner and cabinet-maker, by the wheelwright and shingle-maker, for boxes, packing-cases, toys, violins, etc., piano-making and organ-building. Poles and saplings used for agricultural purposes, ladders,

bars, telegraph-posts, fencing, vine-stakes, wooden baskets, and paper-pulp.

Silver-fir.—Used for the same purposes as sprucewood, and specially useful in buildings, for pillars, also in hydraulic works.

Scots pine, also termed **red-deal**.—Used for the same purposes as spruce, except for musical instruments, shingles and other split-ware; superior to spruce or silver-fir for hydraulic works (piles), bridges, railway-sleepers, or mining timber; used for all purposes requiring durability; esteemed for ships' masts and spars, spars for windmills, conduit-pipes, street-paving, etc.

Larch.—Used for the same purposes as red-deal, and wherever durability is demanded is more highly esteemed than the latter. [In Britain for fishing-boats, barges and fences.—Tr.]

Black pine.—More used in hydraulic works and earthworks than for superstructures, furniture, etc.

Weymouth pine, termed **white deal** in America.—Used in superstructures, especially in roofs; also in cabinet-making, packing-cases, etc. Old wood is preferred.

Cembran pine.—Wood-carving, toys, and cabinet-making.

[**Corsican pine.**—Heartwood similar to red-deal.—Tr.]

Yew (*Taxus baccata*).—Esteemed for bows, cabinet-making, wood-carving and turnery.

Mountain-pine (*Pinus montana*).—Turnery and wood-carving. [Erect variety yields good building timber.—Tr.]

Juniper (*Juniperus communis*).—Fine wood for turnery and wood-carving.

3. Exotic Woods.

Teak (*Tectona grandis*).—The best wood for shipbuilding, superstructures; largely used in railway-carriage-building, and by the cabinet-maker, wheelwright and turner.

Mahogany (*Swietenia Mahogani*).—Highly-esteemed furniture wood; also used for panels, picture-frames, cigar-boxes, etc.

Padauk (*Pterocarpus dalbergioides*) from Burmah and the Andaman Islands. Highly esteemed for railway-carriages and cabinet-making, also in saddle-making.

Hickory (*Hicoria alba* and other species).—Highly esteemed in carriage-making, and for handles of implements.

Ailanthus glandulosa.—Recommended for carriage-making, on account of its strength, elasticity and non-liability to warp.

West Indian cedar (*Cedrela odorata*).—Best wood for cigar-boxes and river-boats.

Ebony (*Diospyros Ebenum*, *D. Melanoxyton*, and other species).—Turnery and wood-carving, pianoforte keys, knife-handles, etc. [Stained holly and hornbeam used to imitate ebony.—Tr.]

Lignum-vitæ (*Guaiacum officinale*).—Bowls, pulley-blocks, policemen's batons; used in gunpowder-manufacture as grinding-rollers.

Jacaranda (*Jacaranda brasiliensis*).—Turnery, inlaid furniture, etc.

Rosewood (wood of several species).*—Furniture, pianoforte-making, etc.

Grenadilla † (West Indies and Honduras).—Used similarly to rosewood, and for flutes.

Horseflesh-wood (*Cesalpinia sp.* from Bahamas).—Violin-bows, machinery.

Greenheart (*Nectandria Rodiaei*, lauraceous tree from Central America, South America, and West Indies).—Ship-building.

Violet-wood (*Acacia pendula* and *A. nomolophylla*, from Queensland).—Inlaid furniture, boomerangs, etc.

Satinwood [wood of different species of trees, among others *Chloroxylon Swietenia*, from Ceylon.—Tr.] Used for furniture and the backs of brushes.

Olive-wood (*Olea europæa*).—Wood-carving, etc.

Quebrache-wood (*Aspidosperma Quebracho-blanco*, from Argentina).—A good substitute for boxwood, for wood-engraving, also for railway-sleepers. *Quebracho-colorado*, for tanning. ‡

American white (or poplar) **wood** (*Liriodendron*).—Used for ebonised show-cases, furniture, carpenters' benches, etc. Takes stains well, and does not warp.—Tr.]

Briar-wood (*Erica arborea*).—Root-stock used for tobacco-pipes.

[**Lancewood** (*Duguetia quitarensis*, Benth. of Guiana, and

* *Vide* p. 35.

† P. 45.

‡ P. 636.

Gualteria virgata, Brazil?) for fishing-rods, handles of golf-clubs, etc. Heads of wooden golf-clubs are of beech, or apple.—Tr.]

Pencil-cedar (*Juniperus virginiana* and *J. bermudiana*).—For lead-pencils, pianoforte-hammers, pipe-stems, turnery and finer cabinet-making.

Pitch pine (*Pinus palustris*, from the Southern States of North America).—Splendid architectural wood, resembles the best larchwood in durability; ship-building, railway-carriages, less used for furniture. [Pitch pine is the name given in Europe to the timber of several pines in the S. States of N. America. They are **Longleaf-pine** (*P. palustris*), **Cuban-pine** (*P. cubensis*), **Shortleaf-pine** (*P. echinata*), and **Loblolly-pine** (*P. Taeda*). The timber of *P. palustris* is called longleaf pinewood in America, pitch pine being the name of *Pinus rigida*, a tree yielding very inferior timber.—Tr.]

American cypress (*Taxodium distichum*).—Used for door and wall-panelling, etc. Lawson's cypress wood is considered durable in America.

Oregon or Douglas-fir (*Pseudotsuga mucronata*).—Excellent for superstructures and ship-building; also as scantling in joinery, for school-benches, etc. [Used by Nansen for "The Fram."—Tr.]

[The wood of many Australian **gum-trees** (*Eucalyptus* sp.) is highly esteemed: thus "Jarrah" (*E. marginata*), ship-building, railway-sleepers, wood-paving; and "Kari" (*E. diversicolor*), wood-paving.—Tr.]

Californian red-wood (*Sequoia sempervirens*), price in London in 1898, 1s. 8d. to 1s. 10d. cubic foot.

Kauri pine (*Dammara australis*), from New Zealand, used for flooring, deck planks, etc. *Dacrydium cupressinum* also, is much used in New Zealand.

Palmwood, for sticks and umbrella-handles.

Bamboos for sticks and furniture, basket-work, fishing-rods, etc.

[In tropical countries, for buildings, masts, shafts for carriages, lance-poles, milk-pails, etc.—Tr.]



PART II.

**THE PROPERTIES, UTILIZATION, VALUATION AND
DISPOSAL OF MINOR FOREST PRODUCE.**

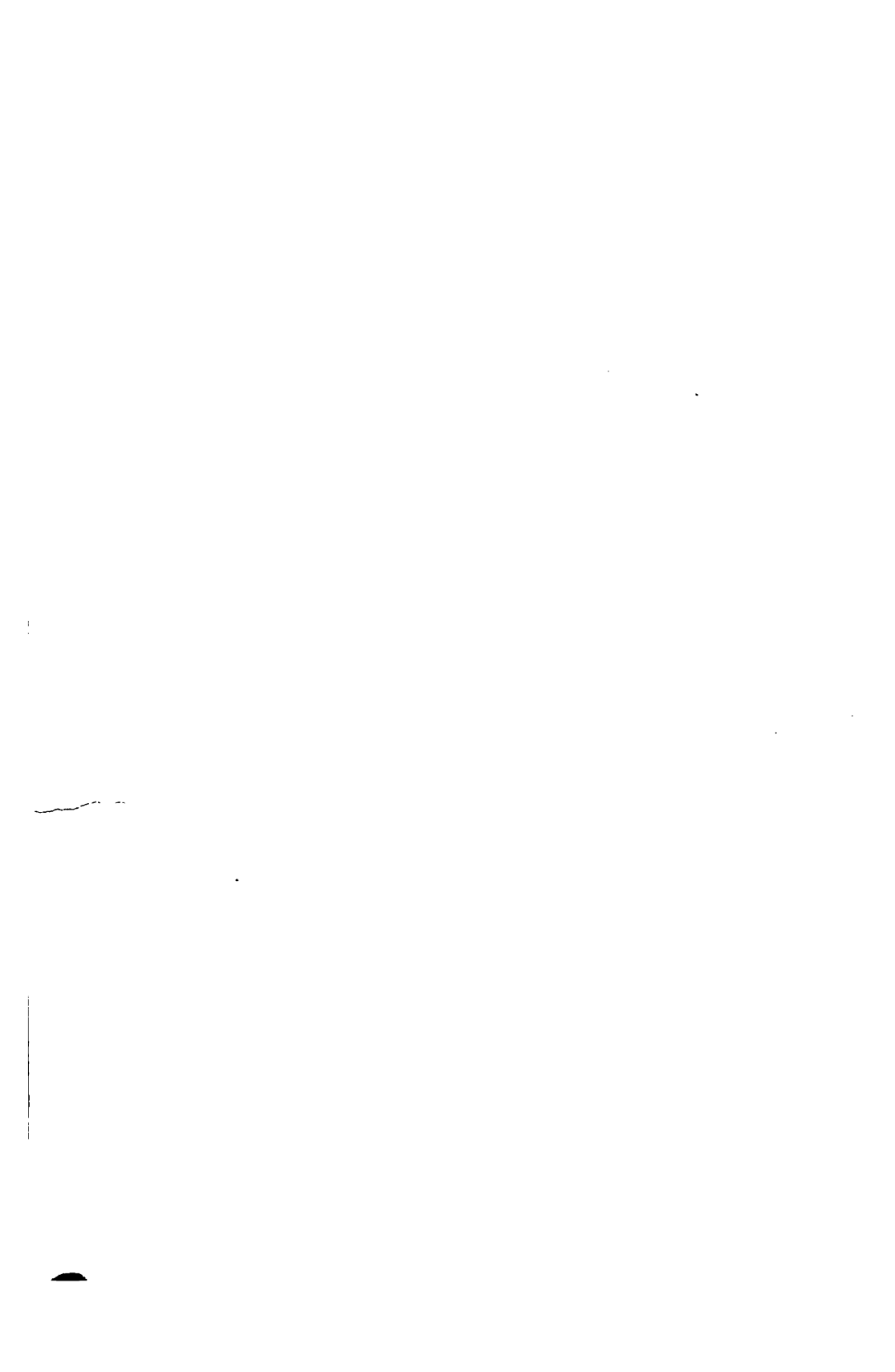

CHAPTER I.

PROPERTIES, UTILIZATION, VALUATION, AND DISPOSAL OF BARK AND ITS CONSTITUENTS.

SECTION I.—ANATOMY OF BARK.

THE bark on a yearling shoot of dicotyledonous and gymnospermous woody species, at the close of the annual growth, may be distinguished as **outer** and **inner** bark. The outer bark (**cortex**) includes the external coating, termed **epidermis**, the cells of which are covered by a suberous and ligneous, waxy layer, the **cuticle**. Through the epidermis there are openings (**stomata**), by which an interchange of gases is effected between the interior of the plant and the atmosphere. The epidermis contains frequently a strengthening tissue, the **hypoderma**, formed sometimes of collenchymatous cells, the walls of which swell when moist. Under the epidermis lie the **chlorophyll** cells, connected together somewhat loosely, so that there is room between them for the circulation of air.

Usually in the first year of a shoot, the cells of the epidermis or those of the subjacent cellular tissue, or even of a deeper tissue, become divided; the inner half form a cork mother-tissue (**Phellogen**), whilst the outer half are brick-shaped **cork-cells**. The latter lose their plasmic contents rapidly and then contain only air, their walls become suberised and are impermeable for air and water. Hence all tissues outside the corky layer die. In order to replace the stomata, a group of cells is formed beneath them, the walls of which are rounded and suberised, so that the intercellular spaces between them allow for the passage of air. These groups of cells are named **lenticels**. In a few species, field-maple, cork-elm, *Phellodendron*, and cork-oaks (*Quercus Suber*, *occidentalis*, *coccifera*, *variabilis*), etc., the cork thickens on the stem and branches into ridges, or into continuous layers, when

it can be utilised commercially. In most species the formation of cork attains a thickness of only a few cells, whilst thin layers of cork, with boundaries like oyster-shells, cut off parts of the tissues from the deeper layers of bark, which turn red or brown, and die. These **flakes of bark** contain scarcely any cork, but are composed chiefly of the tissues of the inner bark.

The inner bark of the shoot consists chiefly of the **bast**, named from the occurrence in it of **bast-fibres**, **hard** and **soft bast**. The former consist of very thick-walled, elongated cells, which are sometimes solitary, sometimes in zones, that alternate with zones of soft bast (*Tilia*); they are rarely absent from the inner bark. Most of the inner bark, however, consists of soft bast, composed chiefly of sieve-tubes and bast-parenchyma. The **sieve-tubes** are organs analogous to the vessels of the wood, but are filled always with aqueous, plasmic contents, which by slow movement supplies nutriment to the tissues. The **bast-parenchyma**, partly in strands parallel to the axis (**longitudinal parenchyma**), partly in horizontal bundles (**medullary parenchyma**) being a continuation of the medullary rays of the wood, serves as a reservoir for starch, sugar, tannin or turpentine, but also passes over into other tissues. Thus, in many parenchymatous cells, crystals appear of oxalate, or more rarely, of carbonate of lime, whilst the plasmic contents disappear and the cell dies and is termed a **crystal-sac**. Tannin accumulates in other parenchymatous cells (**tannin-sacs**), as a refractive solution; in medullary parenchyma, ethereal oils, such as turpentine, camphor, increase continually in quantity, whilst the other contents of the cell continually diminish (turpentine and camphor sacs). Often parenchymatous cells become converted into **sclerenchymatous** or **stone cells**, their contents becoming attached to their walls as a thickening, while the cell becomes either spindle-shaped, or *stellate*, only a small part of the lumen remaining. Sometimes the medullary-ray cells become stony when they emerge from the wood, supplying an internal union between bark and wood (beech).

Elongated cells containing latex (fats and oil suspended in water), also sometimes traverse the bark and are termed **laticiferous ducts** (*Ficus*); their contents are very important

commercially. In conifers, turpentine is elaborated, partly in the interior of the parenchymatous cells, where it continually increases (resin-cells), partly in spaces (resin-ducts) between closely-packed parenchymatous cells. The outer bark possesses only vertical resin-ducts, the inner bark only horizontal ones, which are continuations of those in the medullary rays of the wood.

The dead bark, or rhitidome, arises from the above cell-forms by the scale-like formation of cork; rapid growth in thickness, warm localities, insolation, open crop of trees, tissue tension at the base of branches, etc., favour the early formation of rhitidome and the scaling off of bark (*). At the junction of the inner bark of the wood is the cambium, which forms outwardly the organs of the inner bark. The bark of monocotyledonous woody species, such as palms and bamboos, is confined to a few layers of cells, under which, without any cambium, lies the so-called wood, resembling pith, but traversed by strands of wood. The superficial cells are strongly silicified; there is no formation of cork.

SECTION II.—CHEMICAL, PHYSICAL AND ECONOMIC PROPERTIES OF BARK AND OF ITS CONSTITUENTS.

For the sake of brevity the above will be discussed together with the utilization of the bark.

1. *Properties, Utilization, Valuation and Disposal of Bark.*

The young green bark of our woody species has little durability; as a rule, in the first or second year the green colour is lost when cork is formed, so that reddish, yellow, brown or grey tints prevail. In using saplings of oak, dogwood, hazel, etc., for walking-sticks or umbrella-handles, the colour, lustre and scent of the bark are important. In species of palms and bamboos, the external bark becomes in time very durable owing to its gradual silicification. The rind of bamboos is coloured most variously, according to the species and variety of the plants; it has yellow, brown or black specks or stripes, which render bamboos attractive as fishing-rods,

* H. Mayr, "Die Sekretionsorgane der Fichte und Lärche." Bot. Zentralblatt, 1884.

sticks, or for light fancy furniture. In particular a red colour is prized, that affects the outer rind of a bamboo after exposure to smoke in a chimney, or it has been kept in huts without chimneys.

As soon as rhitidome or dead bark is formed, and bark-scales appear on the exterior of some of our trees such as larch or pine, the tannin in them becomes oxidised and turns red or brown, resembling the transformation of living sapwood into drier heartwood, that is dead in conifers. In trees such as beech, hornbeam, silver-fir, etc., where rhitidome is not formed, or is formed only when the trees become old, the bark is usually grey, owing to its incrustation by lichens; in birches the white betulin gleams through the cell-walls.

When the bark-scales become red the durability of the bark is increased considerably, just as is the coloured heartwood; if the cortex is wounded the tissues exposed to the air redden rapidly, a process of oxidation that protects the wound, the protection afforded being increased by the subsequent provision of a layer of cork. This explains the great durability of very thick barks; as, however, the thick barks of oaks, larch, old pines and Douglas-firs, are separated with greater difficulty in large, regular pieces from the stems, than from those with thin and small scales; it is the latter, *e.g.*, spruce and birch, which are peeled during the life of the trees, and used for covering roofs that are exposed to the rainy west wind. The birch produces a scaly or stony bark only late in life, and owes the great durability of its bark to the betulin in its cells.

The heating-power of the bark is less than that of the wood, even in conifers, in which, according to Mayr's investigations, there is more resin than in the wood; the coarser the bark, the better it is as a combustible. It is peeled off fallen trees in summer in large flakes, about one meter long, or is hacked or beaten off them in winter, and used as combustible bark. This bark is piled in stacks and sold, or given unmeasured to poor people, or to the wood-cutters. Owing to its greater heating-power, birch-bark is used as kindling material, as is very resinous pine wood.

Thick pieces of willow bark (*Salix alba*), which is very light, serve as *swimmers* for fishing-nets; fresh spruce bark

with a scent of turpentine, which may be increased by pouring turpentine on it, is used for catching bark-beetles; birch-bark, owing to its white colour, toughness, durability and heating-power, is used extensively in the north of Europe, America and Asia; small artistic articles, also useful boxes and vessels are made of bark; cherry bark is especially ornamental.

SECTION III.—PROPERTIES, ETC., OF THE CONSTITUENT PARTS OF BARK.*

A. Tanning Materials.

Tanning materials in the form of weak acids of various composition are widespread in all parts of plants throughout the vegetable kingdom; they contain less carbon and oxygen than other carbo-hydrates. Gallic acid or true tannin comes from the galls on our oaks, as well as on *Quercus infectoria*, and from other galls.

Tannin is an amorphous substance with an astringent taste, soluble in alcohol and water; according to their origin, tannins from oak-bark, from oakwood, from spruce-bark, from catechu, etc., may be distinguished: they form salts with inorganic or organic bases (alkaloids); solutions containing iron are coloured green or blue by these different tannins, so that this serves as a test for the nature of the tannin. The most important property of tannin is, that, when it acts on gelatine, a substance contained in the skin of animals that swells in water, it converts these skins into a connected, strong, tough and durable material, leather.† When leather is made by treating skins with tannin, the process is called tanning.

Leather, however, may be formed in other ways from skins; viz., by salts of alumina, especially chloride of alumina with common salt; this process is termed tawing and produces white kid for gloves, etc. Shamoying employs fats or oils and produces soft wash-leather. Tanning also may be done with salts of iron, of chromium (sulphate or chloride of chromium), of nickel, or by utilizing the electric current.

* A. Mayer, "Lehrbuch der Agrrikultur-Chimie." 5th ed., 1901.

† Encyc. Brit., Vol. XIV., "Leather."

In general it is true that tanning with bark produces the best leather, but it is also the dearest.

Tannins are found in all plants; many contain large quantities in their bark, others in their wood or in their leaves and fruits; many plants contain large quantities of tannin. All insect-galls are specially rich in tannin; galls on plants, that otherwise possess plenty of tannin, exhibit the maximum amount of this material. When parts of plants are soaked in water and the latter evaporated, tanning-extracts are obtained; they are very rich in tannin and are mixed with water and used for making leather.

The manufacture of tanning-extracts increases continually, for in this way solutions of proper density are obtained suitable for hides of different thickness and origin, and the business is facilitated and cheapened. A stronger competition in extracts from tropical countries may be expected, owing to the quantity of suitable plants that these countries produce; when better methods of extraction and purifying these extracts have been attained, European tanning industries will be beaten in the contest.

The most important tanning materials come from the following plants, the percentage of tannin being given:

| | | |
|--|-------|--------------|
| Extract of Quebracho wood, dry | . . . | 63 per cent. |
| „ Rhizophora Mangle | . . . | 58 „ |
| „ Quebracho bark | . . . | 50 „ |
| „ Catechu wood (<i>Acacia Catechu</i>) | . . . | 45 to 50 „ |
| „ <i>Polygonum hymenosepalum</i> (roots) | | |
| „ Canaigre | . . . | 42 „ |
| „ Pyingado wood (<i>Xylia dolabri-</i> <i>formis</i>) | . . . | 37 „ |
| „ Uncaria Gambir | . . . | 35 „ |
| „ Sweet-chestnut wood* | . . . | 30 „ |
| „ Hemlock-spruce wood | . . . | 30 „ |
| „ Oakwood | . . . | 28 „ |

Natural Contents in Tannin.

| | | |
|--|----|---------|
| [Indian Gum-kino. (<i>Pterocarpus Marsupium</i>) | 75 | „ —Tr.] |
| Chinese galls (<i>Rhus semiolata</i>) | 70 | „ |

* von Schröder.

| | |
|---|--------------|
| Bark of <i>Rhizophora Mangle</i> (German E. Africa) | 46 per cent. |
| Trillo, husks of the cups of acorns of <i>Quercus Aegylops</i> | 43 " |
| Knopperrn, galls on the cups of acorns of <i>Q. pedunculata</i> | 38 " |
| Valonea, cups of acorns of oaks from Asia Minor and Greece (<i>Q. Aegylops</i> , etc.) | 38 " |
| Dividivi, legumes of <i>Cesalpinia coriaria</i> | 35 " |
| Rhizophora Mangle and <i>R. mucronata</i> , wood | 30 " |
| Canaigre, roots of <i>Rumex hymenophyllum</i> , von Schröder | 30 " |
| Myrobalans, fruits of <i>Terminalia Chebula</i> , etc. | 30 " |
| Quebracho Colorado (<i>Quebrachia Lorentzii</i> , <i>Loxopterygium</i>) | 20 " |
| Oak silver-bark, best quality | 20 " |
| Bark of 40 years' old oak | 18 " |
| Garobile, bark of <i>Quercus coccifera</i> | 18 " |
| Babla, legumes of exotic acacias | 17 " |
| Bark of <i>Quercus densiflora</i> and <i>Picea Engelmanni</i> | 16·5 " |
| „ <i>Tsuga Mertensiana</i> | 15·1 " |
| „ <i>Quercus Ilex</i> | 15 " |
| „ <i>Alnus glutinosa</i> | 14·6 " |
| „ <i>Pseudotsuga mucronata</i> | 13·4 " |
| „ <i>Terminalia tomentosa</i> (India) | 13 " |
| „ Spruce, 25 years old | 15 " |
| „ „ 55 „ | 11 " |
| „ <i>Casuarina equisetifolia</i> | 11 " |
| „ <i>Shorea robusta</i> (India) | 10 " |
| „ Willows and <i>Tsuga canadensis</i> | 10 " |
| „ Old oaks | 8 " |
| „ Old spruce | 8 " |
| „ <i>Alnus incana</i> | 6·7 " |
| „ Silver-fir | 6 " |
| „ <i>Quercus Prinos</i> , <i>Castanea americana</i> | 6·2 " |
| „ <i>Q. alba</i> | 6 " |
| „ <i>Q. rubra</i> | 4·6 " |
| „ Elms | 4·5 " |
| „ Sweet-chestnut | 4 " |

| | | |
|--------------------------|-----------|-------------|
| German galls (on leaves) | | 4 per cent. |
| Bark of <i>Q. Cerris</i> | | 4 „ |
| „ Birch | | 4 „ |
| „ Horse-chestnut | | 3.5 „ |
| „ Ash | | 3.3 „ |
| „ Beech | | 2 „ |
| „ Larch | | 1.6 „ |

The contents of tannin in the bark of *Pinus halepensis*, that is used for tanning, is unknown.

[Besides the above substances mentioned by Gayer, **Mimosa bark** from various Australian acacias—chiefly (*A. harpophylla*) from Queensland, the black wattle (*A. mollissima*), the gold wattle (*A. Pycnantha*), the Tasmanian silver wattle (*A. leucophylla*) and (*A. cyanophylla*)—is largely imported into the United Kingdom. **Sumach**, powdered leaves of *Rhus coriaria* from Mediterranean countries, used for Morocco leather. At Cape Town, the bark of *Acacia saligna*, a naturalised W. Australian species, is the mainstay of the tanneries. **Hemlock bark** (*Tsuga canadensis*) is the most important tanning material in N. America. Mathey states that Quebracho wood imported into Europe from Argentina tends to oust oak-bark. The Director of the Kew Gardens says that *Quebrachia Lorentzii*, Griseb. (*Anacardiaceae*) is “Quebracho Colorado,” Quebracho Blanco is *Aspidosperma Quebracho-blanco*, Schlecht (*Apocynaceae*), but is not used for tanning. The decrease in the annual export of oak-bark from France to the rest of Europe has fallen off since 1893 from 55,000 tons to 40,000 tons, but the extract of chestnut wood from Corsica and French factories besides supplying French tanneries is sufficient to leave 38,000 tons over for annual export.—Tr.]

B. Tannin from Young Oak-Bark.*

Tans prepared from the bark of young oak-trees form the best possible tanning materials. Extensive forest tracts

* 14 cwt. of oak-bark, containing 1 cwt. of tannin, are required to convert into leather 2 cwt. of fresh skins. 2 tons of spruce-bark will produce the same effect. Boppe, *op. cit.* p. 109.

Fr. Jentsch, “Der Deutsche Eichenschälwald u. seine Zukunft.”

stocked with oak-coppice are required for its production, and both in quantity and quality far outvie the yield of older oak-trees. For that reason, a separate account is given here of the production of tan from young oak-trees, as compared with that produced by old oaks and other species of trees. By young oaks are meant both seedling and coppice growth up to a limit of 25 years.

Before considering the mode of harvesting oak-bark, it will be useful to give a short account of the various conditions which affect its quality.

1. *Conditions affecting the Quality of Bark.*

(a) **Species.**—Oak coppice-woods in Central Europe are stocked partly with the sessile oak and partly with the pedunculate species. In the best localities for oak-bark, the Odenwald, the Bavarian Palatinate, the Hundsrück, Taunus, the valleys of the Neckar, and hills of the Middle and Upper Rhine-Valley, it is, with very few exceptions, the sessile oak; only in the lower lands, near the watercourses, does the pedunculate oak take its part in these woods. In the North German plain (as in British lowlands), the pedunculate oak prevails; also in the neighbourhood of the Harz and Siegen, in Silesia and in most oak-bark coppices in Austria. **Each of these species yields the largest quantity and best quality of bark in the locality that is best adapted for it.** In South and Central Germany, the bark of the sessile oak is preferred; in this region also it is much the easier of the two oaks to peel.

Quercus pubescens, which thrives in the warm countries of Hungary and Slavonia, yields as much tanning bark as the above two oaks. *Quercus Ilex* in the south of France is managed (Hüffel) as coppice, and is rich in tannin. Boppe states that *Q. Tozza* is useful. The Turkey-oak (*Q. Cerris*) is used here and there in Austria for the production of bark, but on account of its forming, at an early age, a deeply-cracked *rhitidome*, or dead bark, and because its numerous bundles of bast penetrate the sapwood deeply, and render peeling very difficult, it is of little value. Of foreign oaks, the American

oak *Q. rubra*, contains only 4 per cent. of tannin, but in the west of America, *Q. densiflora*, and in Japan, *Q. dentata*, are the chief oaks that yield tannin.

(b) **Climate.**—Undoubtedly the chief factor in the production of tannin is the climate. **All tanning materials are the richer in tannic acid, the hotter the country in which they are produced;** this is the case with galls and other substances, and is equally true for oak-bark. All factors, therefore, which heighten the temperature for the tree, southerly aspect, loose soil, open crop, increase the amount of tannin in the bark of oak-trees.

The mild climate of the Rhine-Valley and the adjoining districts, especially the Moselle-Valley, Rheingau, the district of the Saar and the Odenwald, affords the best oak-bark coppices in Germany. Oak-bark is also produced commercially in the Silesian hills, Saxony, the North German plain, Brunswick, Mecklenburg, etc., but it cannot compete with Rhenish bark. Many districts in Austria, Hungary and France are situated more favourably for successful production of bark, which is there produced in fairly large quantities. Districts where the vine is cultivated in the open, or where at any rate the better classes of fruit trees flourish, may be cited as suitable for a remunerative yield of oak-bark.*

(c) **Soil.**—The more suitable the soil is for the growth of oak, especially when the climate is suitable, the more quickly the oak grows, the more and better tannin does its bark yield. It is true that coarse bark comes earlier under such circumstances, so that the rotation must be shorter, the better the soil; on a good soil the crop may be denser, as a dense crop retards the formation of rhitidome. A wet soil is prejudicial to oak-bark coppice. The mineral nature of the soil, at least in good climatic localities, appears to be unimportant, and provided the soil is deep, porous and moist, it is indifferent whether the subjacent rock is sandstone, granite, schist, porphyry, limestone or diluvium.

(d) **Age.**—Besides the parenchyma of the cortex, it is especially the longitudinal parenchyma of the bast, in which chiefly

* From the above, it is evident that oak-bark coppice proves more remunerative in the south of England, Wales and in Ireland, than in Scotland. Unfortunately the price is now so low that the production of oak coppice is being abandoned in Britain.

tannic acid is accumulated. As every year the cambium produces a new layer of longitudinal parenchyma and sieve-tubes, the quantity of tannin increases until the rhitidome forms, when the external cortex is killed by the formation of cork, so that much of the tannin is lost. When coarse bark begins to form, the mass of bast and consequently of tannin remains uniform, as just as much new bast as the cambium forms is lost externally in dry bark. At this period it is best to utilize the bark, for then worthless rhitidome continues to increase. Regarding the factors, which expedite the formation of rhitidome, Mayr's observations (*cf.* p. 629) have given the most important, which are: rapid growth (favourable climate and soil); action of sunlight (open crop, especially on poor soil); tissue-tension at the base of branches (production in open, branchy crops). von Schröder, Neubrand and others have proved the following production of tannin:—

| | | | |
|------------|----|--|--------|
| | | 25 years best oak-bark give up to 25·0 per cent. | |
| | 40 | „ „ „ | 18·0 „ |
| | 80 | „ „ „ | 5·0 „ |
| | 18 | „ spruce-bark | 5·0 „ |
| In crops | 25 | „ „ | 12·2 „ |
| | 35 | „ „ | 15·0 „ |
| | 55 | „ „ | 8·8 „ |
| | 55 | „ „ | 11·0 „ |
| Suppressed | 55 | „ „ | 8·0 „ |

(e) **Influence of Light.**—The effects of exposure to light are seen clearly from the above; too dense a crop, mixture with shadebearing trees, overshadowing by standards, etc., reduce the amount of tannin in the bark. Schuberg states that the loss by overshadowing may be 35 per cent. Neubrand, therefore, recommends that oak timber should be grown on areas not devoted to the production of bark.

(f) **System of Management.**—Coppice, with such a rotation as may be determined from the preceding paragraphs, is the system under which oak is grown to produce tanning bark. If the maximum yield of the best quality of bark is desired, the shoots are felled before rhitidome appears; the rotation is shorter the warmer the climate, it varies from 12 years to

20 in cooler districts; fertile soil has a similar influence in shortening the rotation. If, however, some timber also must be produced, as in many communal and private forests of Franconia and Wurtemberg, the rotation is raised to 25 to 30 years, obviously at the expense of the bark. The shoots are felled close to the ground, the area being left clean-felled, and new shoots spring from the stools. If a few standards are left, or if some of the coppice-shoots (*stannels*) are left to grow for two or more rotations of the underwood, the shoots under their shade produce little tannin, so that such a system is not calculated to yield a profitable return.

(g) **Condition of Crop.**—A pure crop of oak gives the best quality and greatest quantity of bark; all other species, especially rapidly growing ones, such as poplar, birch, pine, larch, certainly yield valuable timber, but they prejudice the quantity and quality of the bark. Grass or broom denote either a poor soil, that should be devoted to a more profitable crop, or bad management. Preference should be given not to a very dense crop, nor to a very open one; 1,600 to 1,800 stools per acre form the ordinary crop. After two-thirds of the rotation are over, cleanings should be made to remove all other species except oak, also bent, poor oak-shoots that contain little tannin, as well as the weaker shoots in the stronger clumps. The evils of the removal of litter is not exhibited so readily in other forest systems as in oak coppice; even without this disastrous practice, many oak coppices on bad soil are soon exhausted by the repeated fellings, and by intermediate agricultural crops (*Jhumes*). Pasture also injures the crop, but the lopping of leaves for fodder, practised in a few districts in the Upper Rhine, is worse.

From numerous data it appears that the bark of the best oak coppices in South Germany and Austro-Hungary yield 15 to 20 per cent. of tannin, second-class coppices 10 to 15 per cent., and third-class ones 8 to 10 per cent. In North Germany the yield is 6 to 10 per cent. of tannin.

2. *Harvesting the Bark.*

The work of harvesting the bark may be divided into three parts, preparatory work, peeling and drying.

(a) **Preparatory work.**—As has been stated already, in most oak-bark woods there is a mixture of other species with the oak. Partly in order to obtain more room and time for the business of peeling the bark, partly to avoid deterioration in value of the wood of the mixed species if it is cut during the season of growth, but chiefly in order to expedite the peeling operations, all the mixed wood in an oak-bark coppice is felled at a sufficiently early date so that it may be removed from the felling-area before the peeling commences. This is usually during the winter before the peeling. At the same time, in many places, all oakwood that cannot be stripped, epicormic branches, and shoots growing more or less horizontally along the ground, are removed. In the Odenwald, the side-branches are removed from the oak-shoots, as far as the woodcutter can reach with his billhook.

When also cereal crops are cultivated, as soon as the mixed wood has been felled and the soil is no longer frozen, the first cultivation of the ground around the oak-stools is effected. The sods of grass or heather thus loosened dry better than if the work was undertaken only at the end of the peeling, when the time for sowing is approaching. Whenever there are standards over the underwood, those intended to be felled are marked as soon as the mixed wood has been felled. The felling of these standards, if they are at all large, naturally stands over until the oak-coppice has been felled.

(b) **Season for Peeling.**—Oak can be peeled at any time from May till the middle of July, but peeling should be effected as soon as the buds begin to shoot, which, according to locality, is from the end of April till the middle of May,* and at the first appearance of the foliage, the bark is peeled most easily. In extensive woods, as a rule, the work is commenced after the first flow of sap, as soon as the bark is removable, and is then conducted as rapidly as possible: firstly, on account of the comparative ease with which peeling can be done early in the season; secondly, so that the young shoots may mature their wood before they become endangered by autumn-frosts, and finally, because it is probable that there is more tannin in the

* In England this is from the third week in April till about the third week of May, in Scotland about a month later. A. D. Webster, "Practical Forestry."

bark in spring than in summer, after much of it has passed into the foliage and young twigs of the coppice. Theodore Hartig states that tannic acid is transformed into sugar soon after the foliage has appeared, this begins in the buds and continues with the leaf-development. This fact is evidently in favour of early peeling.

The state of the weather has considerable influence on the peeling. In damp, calm weather, especially when accompanied by light and warm showers of rain, the bark is peeled most easily early in the morning and late in the afternoon; this is also the case when the soil is moist, rather than when it is dry: in windy, dry or cold weather and at midday during hot weather, peeling is difficult. The sessile oak is always peeled more easily than the pedunculate oak, but the latter may be peeled about ten days earlier than the former. Larger stems are peeled more easily at the commencement of the season, smaller stems at the middle and end of the season.

In unfavourable localities, where **damage by autumn-frosts** is inevitable, the forester is obliged to abandon the whole first year's crop of shoots. Then the injured shoots are either cut-back in the following March, making way for a stronger growth which repays the loss of the first year's wood, or the peeled oak-stems are left standing till the succeeding winter; then they are felled, and the succeeding crop shoots up early in the spring. This custom is followed in some valleys in the western Schwarzwald.

[In order to be independent of the natural movement of the sap, H. Maitre, in France, in 1864, adopted with good results a system of peeling oakwood after steaming it, the wood being removed in billets with bark to the factory and there steamed in closed retorts, when bark is easily removed. This system was improved in 1871, by de Normaison, an engineer, who used for the purpose an apparatus weighing only 5 cwt., which supplies a blast of superheated steam. This is used on the felling-area, and by the help of three men and a boy, 15 to 18 stacked cubic meters (10 to 12 loads) can be peeled in a day, and yield a ton of bark. A load of wood and 130 gallons of water are used, and the cost is about £2. The advantages of this method are, that the wood may be felled in winter when

labour is cheap, and that the bark can be removed and stacked in dry sheds instead of being exposed to the weather on the felling-area. Pieces of wood also may be utilised which could not otherwise be peeled. The increased cost of carriage of the wood with the bark on has, however, to be considered.* Experience in Paris has proved that there is hardly any loss of tannin due to this method, and that the leather produced by tan from steamed bark is soft and fine, and excellent for saddlery, but not so good for the soles of boots.—Tr.]

(c) **Method of Peeling Bark.**—The bark is peeled either after the stems have been felled, half severed or knicked, or from standing stems.

Peeling felled wood is the method prevailing in Germany; it is followed in the Odenwald, Franconia, the Palatinate, Baden, Württemberg and many other districts. The workmen, divided into small parties, commence felling the coppice-shoots, and should be careful to cut them smoothly and close to the ground. All the crop should not be felled at once, but only as much as can be peeled immediately. It is reckoned that a skilful woodcutter can keep two men employed in peeling. It should be a rule, that every evening not a piece of felled wood remains unpeeled; for only from wood which has just been felled can the bark be peeled readily, whilst from poles which have been lying felled for 24 hours, the bark can be removed only by knocking it with a mallet. As soon as a lot of oak coppice-shoots has been felled, freed from tops and side-branches, and the parts to be barked set aside, the operation of peeling is commenced. This is done differently in different countries. In the Odenwald, the Palatinate, Wurtemberg, etc., the coppice-shoots and all other wood fit to be peeled are cut into round billets of the length customary in the district; the workman then takes each billet and removes the bark, as far as possible, without tearing it. In order to do this, he lays each billet on a stone or log, beats it with the back of a small hatchet along a certain line, so that the bark opens-out and separates from the wood along this line. In case the shoots are to be used in their full length, as stakes, for hurdle-wood, etc., they are supported at one end on a

* Boppe, *op. cit.* p. 105.

treble made of forked sticks. In both cases, the bark is stripped-off, either in meter-lengths or of the length of the billets. Only when the shoots are smooth and the bark easily removable, can beating be dispensed with; the workman then severs the bark in a line along the piece of wood and peels the latter with his hands and with the peeling-iron.

In Franconia, felled wood is barked differently, being cut into lengths as billets, after being peeled. The shoots having been topped are arranged horizontally on trestles to facilitate the peeling, and the bark is peeled with an ordinary knife in

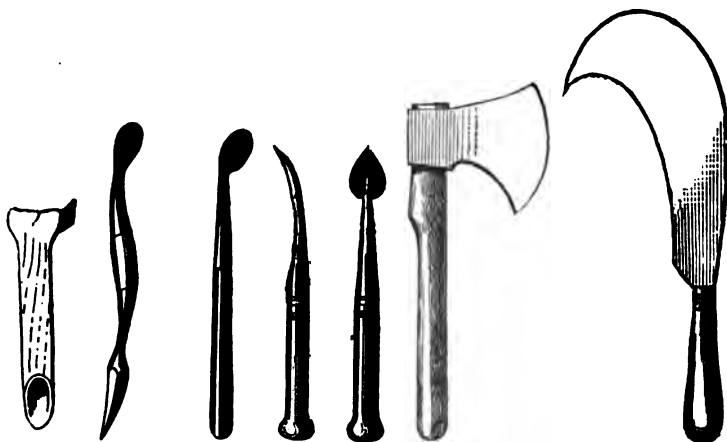

Fig. 346. Fig. 347. Fig. 348. Fig. 349. Fig. 350. Fig. 351.
(After Boppe.) Implements for peeling bark.

longitudinal pieces, the full length of the shoots, without first being beaten. These strips of bark are then rolled together into bundles 60 centimeters (2 feet) long and 30 centimeters in girth, and dried.

In the lower Main valley the shoots are peeled also before being cut into billets, the bark being removed in pieces of the length of the billet, with the peeling-iron. Then all shoots over 8 centimeters (3 inches) thick are sawn into billets, whilst smaller pieces are cut into lengths with a hatchet and their bark beaten with the back of the hatchet. The use of a saw, instead of the hatchet, saves much bark.

The instruments used in peeling bark vary greatly in

different districts, but are of an extremely simple character. The most important instrument is the peeling-scalpel (Fig. 346), a piece of wood, or bone, shaped like a chisel at one end, and about 20 to 30 centimeters (8 inches to 1 foot) long. [In France this is made from the tibia of an ass or horse, with a sharp steel blade attached to its upper extremity (Fig. 346).—Tr.] This simple implement is preferable to those made of iron, the best of which are: (Fig. 347) a peeling-iron used near the river Saar, (Fig. 348) one used near the river Lahn, (Fig. 349) Wohmann's peeling-iron. For felling and removing the branches of the shoots, the hatchet (Fig. 350) is used in the Odenwald, its back being also used in beating the bark; Wohmann's billhook (Fig. 351) is also an excellent instrument,



Fig. 352.—Nicked shoot for peeling.

especially for peeling bark from standing stems. The shock, owing to the beating, loosens the bark from the wood at other points besides those beaten, but the peeling is not always so easy that the bark can be removed in one piece from the wood merely after beating it on one side; in that case, the billet must be turned and beaten all round, and the peeling-knife brought into play. In every case, however, beating the bark is a rough operation, always causing a loss of tannin, for the cambium-zone which holds the most tannin, is crushed easily, and if rain should fall, much tannin is washed away; besides this, the beaten places soon turn brown and become much sooner mildewed than when the bark is not beaten. Considering that the loss of tannin, owing to beating, has been estimated at about 20 per cent., it is desirable that beating should be abandoned as much as possible, and wherever it is obligatory, that it should be done with wooden mallets, and the shoot,

which is being barked, supported on a broad log or stone, as is done in places along the river Moselle. The smaller and knotty shoots always must be beaten, as well as all the thinner branches, which in the Odenwald are peeled down to 1 centimeter in thickness ($\frac{1}{4}$ inch).

Peeling nicked shoots is customary near Burgen, Aschaffenburg and the Hundsrück; it consists, as is shown in Fig. 352, in cutting the stem (b) half-through and peeling it, after its base (a) has been peeled standing.

A considerable advantage results from this method as only a little beating is necessary. Then the bark is peeled, usually in long strips, as in the following method.

Peeling standing shoots is employed at Lorch on the river Taunus, in some of the Schwarzwald valleys, many oak-bark districts of Austria, and in France almost universally. The branches are lopped from the stem as high as the men can reach, and a strip of bark 2 to 4 centimeters (about an inch) broad is peeled either with the bill-hook (Fig. 351), or the peeling-scalpel (Fig. 346). These strips are rolled into loose bundles and hung from the trees to dry. The rest of the bark is peeled with a scalpel, without girdling the tree, and is left hanging on the stem to dry. Generally a ladder is used in order to peel the upper part of the stem. Thus the bark is not beaten, but that on the branches is not utilized.



Fig. 353.

In many districts in Austria, all the bark on standing stems is cut longitudinally in strips, and these are then peeled. It would be supposed that in peeling standing shoots they should first be girdled close to the ground in order to protect the roots from being peeled. Often this precaution is omitted, not without prejudice, as may be imagined, to the reproduction of shoots from the stools.

[It is now customary nearly all over France in peeling oak-bark, to make a circular cut through the bark of the stem at a suitable height (say $3\frac{1}{2}$ feet) from the ground and a similar one level with the ground (Fig. 352); a longitudinal cut is then made between these two marks and the bark removed by means of the bone-scalpel (Fig. 346) in a single

piece, forming a roll of bark, which can then be dried. Another strip is removed, as high as a man can reach, and then the stem is felled, and peeled in a similar manner, as it lies on the ground.—[Tr.]*

It is not decided yet whether peeling felled or unfelled stems is preferable, although most foresters prefer the former method; much may be said for and against either. It is contended against peeling standing stems, that it is not possible to use the bark on all branches down to the thickness of a finger, for frequently the upper part of the shoots in this method is left unpeeled.† At the same time, to peel standing stems is advantageous in economising labour; in better drying the bark, which remains hanging on the stems, and because beating is then unnecessary. The chief disadvantage of peeling felled stems consists in the fact that beating cannot be avoided; in consequence, the bark depreciates in quality and mildews, the work is done more slowly, and there is a considerable loss of bark (about $2\frac{1}{2}$ per cent.) when the axe is used to shorten the billets; whilst by peeling standing stems, the undamaged bark is obtained in a closed roll.

As regards economy of labour, Neubrand states that a workman at Lorch will peel daily from standing stems $2\frac{1}{2}$ to 4 cwt. of bark; by beating, however, with difficulty, $1\frac{1}{2}$ cwt. Neubrand considers beating the worst method, the best being that in force in the forest-range of Insbach, near Donnersberg.

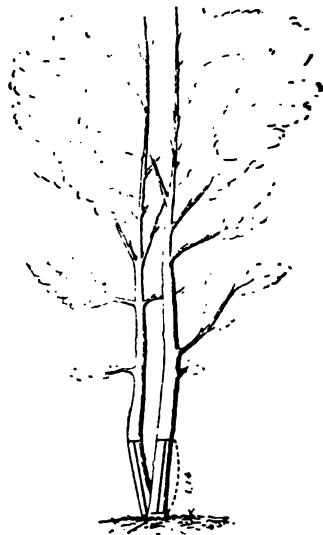

Fig. 354.—Peeling standing stems.
(After Boppe.)

* Boppe, *op. cit.* p. 103.

† [This is not the case with this method in France.—Tr.]

Here, the lowest part of the bark up to $1\frac{1}{2}$ meters (4 feet 10 inches) is removed from standing stems, which are then felled level with the ground, but the stumps not completely severed; the top is removed and peeled by beating, whilst the bark from the rest of the stem is removed by the scalpel. Such a method is preferable to felling the whole stem before peeling, for the quality of the bark is not impaired, and the valuable upper bark can be utilised as well as in the other method.

(d) **Drying the Bark.**—No part of the business of harvesting bark has such influence on its value as the way in which it is dried. Any neglect here may cause considerable loss. **The less rain falls on the peeled bark, and the more quickly the drying process is conducted, the better.** Observations made by Gantter * show that rain may deprive the bark of 70 per cent. of its tannin, the relative loss being more considerable with rich bark than with inferior material. If the rain falls at the commencement of the drying process, it is chiefly the tannin which is washed away; later-on, other soluble substances in the bark. Undoubtedly rain is more disastrous on freshly-peeled bark than on bark nearly dried; but the effect depends also on the persistence of the rain. Tanners fear the effects of rain most on dried bark, but probably only on account of its consequent loss in weight. The chief point in this work is, therefore, to effect the drying of the peeled bark in such a way that the almost certain spring-showers may cause it to lose as little tannin as possible, and mildew may not ensue. The best conditions for drying are to isolate the bark from the moisture of the ground, to expose it fully to air currents and protect it from spring-showers. It would have the best effect on the quality of the bark if light sheds were erected in the felling-areas to keep-off the rain. In Hungary, Transylvania, etc., bark is heaped on well-ventilated stages and protected from the rain and dew by large tarpaulins, mats made of reeds, corrugated iron sheets, etc. These coverings are supplied, not only in rainy weather, but regularly every night to keep off the dew. In many places the pieces of bark are piled like a roof, or in a pyramidal shape,

* Handelsblatt für Walderzeugnisse, XV. Year, No. 17.

being placed, as in Fig. 355, against a horizontal pole supported by two forked stakes, the rough bark outside. At Lorch, several poles are placed parallel to one another, with one end on the ground and the other on a pole supported by

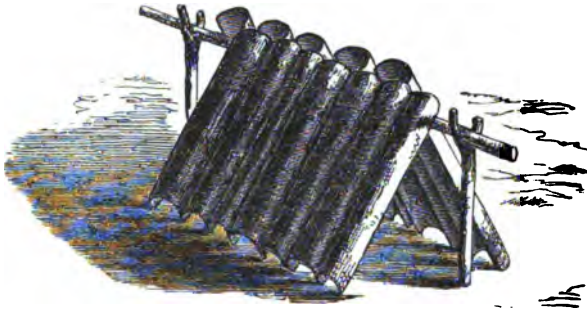

Fig. 355.—Drying bark on trestles.

two forked stakes, thus forming a gently sloping stage, usually towards the south, and on this the rolls of bark are placed to dry; or the stages may be horizontal, the poles being supported by pairs of forked stakes, and the bark placed on it.

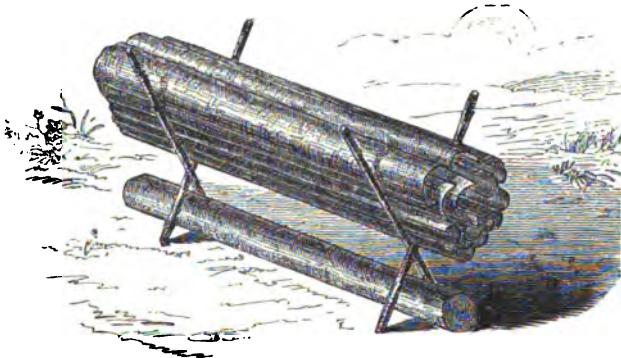

Fig. 356.—Method of drying bark.

In the Rhine-valley, drying on trestles is most usual, the bark being supported on stakes driven crosswise into the ground (Fig. 356). In this case it is necessary to place the rolls of bark so that they overlap one another, and with the outside uppermost. The looser they are placed, and the fewer

pieces there are on a trestle, the quicker they dry. This is undoubtedly a good method of drying bark, as it nowhere touches the ground.

Whenever the bark is allowed to form rolls, the drying process is very simple, for generally the rolls are removed as soon as they are prepared, and left to dry in well-ventilated sheds. If the rolls of bark are not removed till the end of the felling, they should be piled in pyramids of five to ten on the felling-area. The rolls should be tied loosely together so as to admit the air, but the middle of the rolls, enlaced by the withes, frequently becomes mouldy.

When standing shoots are peeled, drying the bark does not give any trouble; the strips of bark remain hanging on the trees, and roll-up to such a degree in drying that the inner surface of the bast is thoroughly protected against rain. The loose pieces are hung-up to dry on the top of the stems.

Evidently the degree of dryness attained may vary considerably. Practically, besides the green bark, freshly stripped from the tree, traders distinguish air-dried from meal-dried bark. Bark is said to be air-dried, when, on bending, it breaks easily; meal-dried, when it has lost all flexibility and become brittle. According to Baur, bark, in passing from the green to the air-dried condition, loses considerably in weight; it loses from 32 to 49 per cent., according to quality, that from the branches losing most weight, and coarser stem-bark the least. The loss in weight, therefore, increases with the age of the wood, *i.e.*, from the foot of a shoot to its top. In a similar way shrinkage of volume takes place, from 21 to 41 per cent., according to the part from which the bark is taken.

In passing from the air-dried to the meal-dried condition, the bark loses in weight only 4 to 5 per cent., whilst it shrinks in volume 11 to 20 per cent. Schuberg found a loss of weight of 35 per cent. for bark passing from the green to the air-dried condition, and a further loss of 14 per cent. in becoming meal-dried.

3. Assortments of Bark and formation of Sale-Lots.

In estimating the yield of bark, greater care than is usually bestowed should be given to the business of assorting the bark

according to quality; the forest-manager should go beyond customary limits of assortment, and have at any rate two classes of silver-bark, for these are the lots which determine the value of the produce. This is both in the interest of the forest-owner and of the purchaser, and will materially decide the results of the sale.

Dry bark is sold differently in different places. Usually larger or smaller bales of it are prepared; or, as in Franconia, it is made into round bundles.

In the Rhine-valley, three sorts of bark are recognised: silver-bark, seconds and coarse bark. Silver-bark (*Glanzrinde*, *Spiegelrinde*) is the bark cut from shoots up to 8 centimeters (3 in.) diameter, in Wurtemberg, 12 centimeters ($4\frac{1}{2}$ in.), when measured unpeeled; seconds (*Raitelrinde*) is from stems 8 to 25 centimeters (3 to 10 in.) in diameter, in Wurtemberg ($4\frac{1}{2}$ to 10 in.), also the smooth bark from the branches of these stems; coarse bark (*Grobrinde*) is from branches and stems exceeding 25 centimeters (10 in.) in diameter. Silver-bark is also subdivided into three classes, No. 1, that from the lower part of the stem, No. 2, from its upper part and No. 3, from branches. The third class is, however, the richest in tannin, sometimes thrice as rich as the first class, although traders value them in the inverse order.

The bales of bark are of various dimensions, according to locality. In some of the Rhineland districts large bales weighing 30 to 35 kilos (say 70 to 80 lbs.) are usual, which hardly can be carried by a man. Tanners prefer the bales to be about one meter long and of the same girth; these dimensions are obligatory in parts of South Germany, and each bale then weighs about 15 kilos (34 lbs.).

As soon as the bark is dry, it is made into bales; this is done either by hand or in presses. The important points in both cases are to give the bale its proper dimensions and fasten it securely so that it may withstand the shocks of ordinary transport without opening, or the loss of any bark. Whenever the bark is dried on trestles (Fig. 356), the bale is tied as it lies on the trestle. The presses used in the Odenwald are made as follows:—four stout peeled stakes are driven in pairs into the ground at distances somewhat less apart than the

proposed length of the bale. Between these pairs of stakes the withes and the bark are laid on the ground. Large rolls of bark are placed first and piled on either side between the stakes. As many smaller pieces of bark as a man can take in both arms are then placed in the press between the large rolls of bark, until the bale has become about the right size, when large rolls of bark are placed on the top and then the bale is fastened by means of withes, iron wire, or manilla hemp. The whole exterior of the bale consists of the larger rolls of bark, the smaller pieces being inside. The fastenings should not be too tight, or the bark may crack and break into pieces, and the bale become loose; this is important, considering the distance to which bark is sometimes transported. Generally the large external rolls will stand fairly tight fastening.

The peeled wood is stacked in the usual manner.

4. *Sale of Bark.*

No forest produce is sold so variably as tanning-bark. Taking into consideration whether the sale is left chiefly to the purchaser, or conducted by the forest-owner; the chief kinds of sale are:—of the coppice, by **area** or **unit of produce**; and of the converted material, by **weight** or **volume**. As regards the public or private nature of the sale, sale to the highest bidder is the rule; but although to the apparent prejudice of the forest-owner, sales by private contract are not unusual, often before the market-prices of the previous year's bark are known.

(a) **Sale by Area.**—The mature coppice is subdivided into larger or smaller lots, and each lot, both wood and bark [or these separately.—Tr.], is sold to the highest bidder. The purchaser of a lot converts both wood and bark at his own risk, subject to certain silvicultural conditions imposed on him at the sale, and endeavours to dispose of the produce to the best advantage.

As by this method it is impossible to form any correct estimate of the value of the crop, it should be absolutely abandoned. At Hirschhorn, a sale-condition is enforced on

the purchaser of the lots of coppice, that he should sell the bark at a fixed price per cwt. to the tanners.

Similarly, some sales are conducted which provide that the forest-owner shall have the converted wood and the purchaser the bark, after the latter has converted both the bark and the wood at his own cost. This is one of the most usual modes of sale and is very convenient, though not always most profitable for the forest-owner : for, although the felling and conversion is effected under the supervision of the forest staff, and the purchaser's workmen must submit to silvicultural rules, yet they study the interest of the purchaser rather than that of the owner. Good supervision may, however, remedy matters in this respect.

(b) **Sale by unit of Produce.**—In this mode of sale also, the price of the bark is arranged before it is harvested, but the felling and peeling is undertaken and paid for by the forest-owner. This mode of sale is far preferable to those described under (a), and is generally the best to adopt ; the workmen are engaged by the forest-owner and will see to his interests, and the conversion of the wood will be arranged more profitably, as firewood, or timber for agricultural purposes, according to the requirements of the case. There is here nothing to interfere with the best possible harvesting of the bark, and the maintenance of its quality ; for if the workmen are paid by piecework, according to the weight and quality of the bark, their interest in the matter will be enlisted.

This mode of sale has been adopted recently in several places in Baden, Wurtemberg and the Palatinate, and in parts of Prussia.

(c) **Sale of Converted Material.**—Another possible mode of sale is when the forest-owner converts both wood and bark at his own expense and sells the produce afterwards. This method is adopted rarely ; it is mentioned here only in order to show how necessary it is to arrange for a purchaser of the bark before the felling. If, however, forest-owners were to provide large sheds for drying and keeping the bark, the trade would benefit, and this would lead to the whole bark-harvest being conducted by the forest-owners.

5. Measures for Bark.

In selling bark-coppice by area, it is important to know how to estimate the quantity of bark that has been harvested. This may be done by measuring its rough volume; by weight; or indirectly, by measuring the volume of the barked wood, from which the yield of bark may be determined by means of experimental ratios.

Measurement by rough volume is done by the bale. Although this method has the advantage, that the bark can be removed as soon as it is sufficiently dry, and there is thus little danger of any loss of tannin, yet it affords for both purchaser and seller such an uncertain measure of the yield, that it is employed only to a limited extent. If measurements are to be made by bales, not only the length and girth of the bales must be nearly uniform, but also the bark must be packed uniformly in each bale.

The best, and at present, the most usual sale-measurement is the weight. As soon as the bark is dry it is packed in bales and weighed in the forest by means of a steel-yard or spring-balance. Everything then depends on the degree of dryness of the bark, for green bark must lose 40 to 50 per cent. of water to become air-dry. In the interest of the purchaser, however, the bark must not be kept in the forest a day longer than is necessary, owing to the danger of a loss of tannin. Although one might anticipate disputes between seller and purchaser as to the proper date for measuring bark, yet experience proves that this seldom happens. A prudent tanner will allow the bark to remain in the forest no longer than is absolutely necessary; he knows that it is more to his interest to pay for the bark when somewhat moist than to risk its being washed badly by rain.

The third mode of measuring bark consists in measuring the peeled wood, and assuming that its volume will bear a fixed ratio to that of the bark which has been harvested. This custom is followed always in Franconia. It cannot be denied that this method has certain advantages, as it saves labour and avoids inconvenience, but to it is attached the great disadvantage that the ratio between wood and bark varied

every season, and neither purchaser nor seller can be certain how much bark has been bought or sold. It may be suggested that an average yield being maintained matters will adjust themselves in a few years' time ; but on the whole the forest-owner will lose, for generally as long as a purchaser is uncertain of the amount of bark he will obtain, he will bid below its proper value. This is, therefore, the most rough and ready of all measurements.

According to Baur, the average ratio of the bark in cwts. to the peeled wood is as follows:—One stacked cubic meter (95 st. cub. ft.) of peeled wood will yield—

| | |
|----------------------------------|-----------|
| Silver-bark | 0·91 cwt. |
| Seconds | 1·69 „ |
| 16 years old stem bark | 1·45 „ |
| 25 „ „ „ | 1·95 „ |

6. Yield of Bark-Coppice.

Jentsch * has calculated the average yield per acre of bark-coppice in West Germany for various rotations and qualities of soil as follows in cwts. of bark:—

| Quality of Crop. | Rotation in Years. | | |
|------------------|--------------------|-----|-----|
| | 15. | 18. | 20. |
| 1 | 60 | 72 | 80 |
| 2 | 46 | 55 | 62 |
| 3 | 33 | 39 | 44 |
| 4 | 22 | 26 | 29 |
| 5 | 12 | 14 | 16 |

A. Bernhardt gives the following quantities of wood in solid cubic feet per acre:—

| Quality of Crop. | Cub. Feet. |
|------------------|------------|
| 1 | 98 |
| 2 | 84 |
| 3 | 70 |
| 4 and 5 | 56 |

* Jentsch " Der Deutsche Eichenschälwald u. seine Zukunft. Berlin, 1899.

7. *Present Condition of Revenue from Bark-Coppice.*

During the last ten years complaints about the depressed condition of bark-coppices in Germany have increased. The monopoly of the market, which, according to Jentsch, it claimed formerly, has gone; the tanners now dictate the price of bark. This revolution is due to the combined action of many unfavourable causes, of which the following are the most important:—An enormous increase in the leather industry, now amounting to about ten million hundredweights of hides, requires far more tan than Germany can produce. Hence there has been a great import of tanning products, viz., oak-bark from France, Austro-Hungary, Belgium and Holland, as well as of tanning materials from other countries. As a result the price of oak-bark has gone down, so that practically the revenue of badly situated or badly managed bark-coppices has disappeared. The imported materials are either better or cheaper, or they are extracts that allowed tanners to give up tan-pits, and shorten considerably the period required for tanning leather. Besides this, several kinds of chemicals have rendered tannin no longer essential for leather-manufacture. The cost of working the bark-coppices has steadily increased.

Jentsch* states that at a price of 4*s.* 6*d.* per cwt., with 15 years' rotation, interest being reckoned at 3½ per cent., the annual revenue of an acre of bark-coppices varies from 10*s.* 5*d.* for first quality, to 1*s.* 4*d.* for fourth quality, while at a price of 8*s.* 6*d.* per cwt., they are 7*s.* 2*d.*, to zero.

Taking one agricultural crop off the land after cutting the coppice does not improve the revenue, taking two crops yields from 5*d.* to 2*s.* per acre; but on the other hand those crops deteriorate the soil, and it is uncertain whether the loosening of the soil and the consequent improvement of the shoots compensate for this, or not. Jentsch asserts that on a good soil and by good management (Mayr adds, with a suitable climate) oak-coppice is still a paying concern, and that bad returns are due to bad management. [In 850 acres of oak-coppice, near Tavistock, where climate and soil are suitable

* Jentsch, "Der Deutsche Eichenschälwald u. seine Zukunft. Berlin, 1899.

and the management good, only 2s. 6d. per acre is obtained for 25 years' growth of bark-coppice, wood and bark, the latter selling at £3 15s. 0d. a ton, say 8s. 9d. per cwt.—Tr.]

In Germany it is impossible to put such a heavy duty on imported tanning materials, that the indigenous production of oak-bark, worth annually £4,500,000, can be aided; for the value of the annual production of leather is about £30,000,000. Hence the future of the oak-coppice depends solely on improved management. This can be effected in two ways: **Improvement in the condition of the coppices**, so that more bark of better quality should be produced; also by **improving the methods of harvesting and selling the bark**.

As most of these coppices belong to communes and private owners of small estates, it is difficult to improve them, for this cannot be done unless the managers have the requisite technical knowledge. If the owners of oak-coppice would co-operate in the management of large areas, and would introduce cleanings, thinnings and soil-improvement, while the bark is harvested and dried properly and the middleman abolished, some improvement might be effected.

On inferior soil, in localities with cool climates, or on cold aspects, oak-coppice is doomed; it must be abandoned in such places, and more remunerative systems of culture introduced, either by means of agriculture, or by growing trees for wood and not for bark. High forest of broadleaved trees, or of conifers, [coppice-with-standards of ash or chestnut under-wood, and larch, poplar, oak and ash standards.—Tr.] are suggested. It is not within the range of forest utilisation to propose here any general measures of national forest-economy.

SECTION IV.—THE BARK OF OLD OAKS.

As the tanner will pay only a very moderate price for the bark from young oak-trees, he cannot be induced easily to utilise the inner bark of old oaks or other trees; considering that their cortex and bast are relatively poorer* in tannin than that of oak coppice-shoots.

* The cortex and bast of oaks, 40 to 50 years old, according to Wolff, is as rich in tannic acid as that of oak-coppice, provided all corky substance is excluded.

In some districts in Hesse and Hanover, old oaks are peeled standing in the spring, left standing till winter and then felled. This method [also employed in the Forest of Dean.—Tr.] gives superior timber to that felled in the spring. As a rule, in Germany, bark is peeled from old oak trees after they are felled, and here also only as many trees should be felled as can be peeled in a day. The men engaged in peeling, who are employed usually by tanners, or merchants, follow close on the woodcutters. [In Britain, the trees are peeled partly before being felled, and the woodcutters, who do all the work, are paid for both operations according to the quantity of bark they obtain.—Tr.]



Fig. 357.—
Barking-iron.

The workman makes a cut down the stem and through the bark with the barking-iron (Fig. 357). The bark is then peeled in large flat pieces by means of the iron and the workman's hands. It can be removed rarely without constant beating. Wherever the bark is sold stacked, the pieces are cut to the required length (say one meter). The less common method, of peeling standing trees, is easier to effect, although ladders are required.

The most troublesome part of the work is to peel the crooked knotty branches, which always must be beaten. Sometimes, instead of the barking-iron, the common felling-axe alone is used. If the weather is favourable an experienced workman will peel 4 or 5 large oak trees in a day. Trimming the bark, however expensive it may be, increases its value greatly. The more thoroughly the cracked and dead outer bark, or rhitidome, which in old trees forms 50 to 60 per cent. of the bark, is removed from the inner and more sappy bark, the more valuable will be the produce; the percentage of tannic acid in old bark would not be so low as compared with young bark, were all the hard outer bark removed. Wherever trimming is done it should precede peeling, and is effected best on standing trees.

The peeled bark is carried to a neighbouring blank to

be dried. For this purpose usually it is placed horizontally on a stage made of poles, with the cambium side downwards to protect it against rain. As soon as it is dry it is piled like firewood between stakes, being well trodden down in the stacks. If, as is usually and most conveniently the case, the bark is sold in stacks, they should be made by an employee of the forest-owner; in Wurtemberg, bark is packed in bales for transport. The bark may be sold also at so much a tree.

A stacked cubic meter of old oak-bark weighs 130 to 200 kilos (4 to 6 cwt. per load of 50 cubic feet) and more, according to the amount of moisture it contains. More fresh bark than dry bark goes to a stack, for it is easier and softer to pack in the former case.

Sale by the amount of peeled wood is more uncertain than in the case of young bark, owing to great variability in the proportion of bark to peeled wood. There is nearly as much tannin in the branches of trees as in coppice-shoots.

[In England it is considered that 1 ton of bark comes from 120 cubic feet of wood, and at £3 a ton, the value of the bark pays for the felling and leaves some margin of profit over. Railway-companies also charge for the bark that is on the logs they transport, so that peeling reduces the freight. In France, only standards over coppice are peeled, not high forest oaks.—Tr.]

SECTION V.—SPRUCE-BARK.

Spruce-bark is harvested much more extensively than old oak-bark, and in eastern and southern Germany and the adjoining Austrian districts, when mixed with Knopperrn galls, valonea and silver-bark, it is used largely for tanning. It can, however, be used only in the preliminary stages of tanning, or for tanning thin skins; thick skins are tanned with spruce-bark only when largely mixed with other tanning materials. As most spruce forests are in mountainous regions, where, on account of the climate, summer-felling prevails, and the wood must be peeled, owing to the danger of insect-attacks and the necessities of transport, many of the difficulties which occur in utilising oak-bark are avoided.

In order to obtain spruce-bark, the felled stems, after being

cut into saw-mill butts, are peeled with the barking-iron or the axe, so as, if possible, whenever the log is not too thick, to remove the bark in one piece. The men, however, prefer peeling firewood blocks a meter long, to peeling heavy logs and butts. The bark is spread out on poles or placed on an incline to dry, or arranged as in Fig. 358, the roof-like structure thus formed being covered with numerous other pieces of bark, and thus secured against the rain. In setting-out the pieces of bark to dry, they are bent outwards so as almost to break along their middle line, in order to prevent them from rolling up, otherwise they would not dry thoroughly.

As in all trees, the bark of young spruce contains more



Fig. 358.—Drying spruce-bark.

tannic acid than that from old trees; and the bark of trees grown wide apart, or in the open, and of trees exposed to the south or along the borders of a forest, is richer in tannic acid than those under opposite conditions.

In most countries dried spruce-bark is stacked like ordinary firewood and sold by the stack; a stacked cubic meter (35 cubic feet) contains 0.3 cubic meters (10 cubic feet) of solid bark. Well-stacked, smooth, middle-aged spruce-bark, when air-dried, weighs from 150 to 175 kilos per stacked cubic meter ($4\frac{1}{2}$ to 5 cwt. per load of 50 cubic feet). It is sold also by the tree, by the hundred rolls, by the volume of the barked wood, or by the drying stack (Fig. 358) containing 12 to 15 pieces of bark. Selling by the amount of peeled wood is the simplest method, provided sufficiently accurate ratios between the wood and bark have been ascertained; for wood 80 to 100 years old,

this ratio is as 1 to 8 or 12, averaging 1 to 10. In younger wood the ratio is more in favour of the bark.

SECTION VI.—BIRCH-BARK.

Birch-bark is more in use for tanning in the North of Europe, especially in Russia; in Germany, hitherto, it has been used only experimentally. It contains much less tannic acid than oak-bark, and even than that of spruce, but in the north repays harvesting owing to the absence of oak. In Germany, it is not used for tanning, but for macerating sole-leather, with the object of opening the pores of the leather and preparing it to receive tannin. Leather tanned with birch-bark is softer and less water-tight than that tanned with oak-bark, but it has a lighter colour and a better appearance.

Birch-bark is harvested in the same way as oak-bark, it can be peeled only about a fortnight later than the latter, though the birch shoots first. It is easier to peel old birch trees than young stems and branches, but they are not nearly so easy to peel as are oaks. The few data regarding birch-bark give 65 to 80 kilos of air-dried bark for a stacked cubic meter of peeled birch billets, from trees 20 years old (say 2 cwt. of bark per load of 50 cubic feet of wood).

SECTION VII.—LARCH-BARK.

Larch-bark is harvested seldom in Germany, but is used extensively in Russia, Hungary, and Austria for tanning. Accordingly to Wessely, in the Carpathian Mountains and the Alps, it is preferred to the bark of spruce and birch. Probably it is unsuitable for tanning sole-leather, but deserves consideration for tanning calf-skin and when added to other tanning materials. Owing to the straightness and freedom from branches of the larch, it is peeled more easily than oak.

SECTION VIII.—WILLOW-BARK, ETC.

Willow-bark contains a considerable amount of tannic acid. Besides *Salix Caprea* and *S. alba*, the so-called osier-willows are best in this respect. According to data furnished by the

Moscow Academy, the quantity of tannic acid in willows varies between 8 and 12 per cent. In Russia, it has for a long time been customary to use willow-bark for tanning, especially in preparing that flexible, water-tight, shining upper leather, for which Russia is so famous. The pleasant scent of Russian leather is due to soaking it with birch oil, distilled from the white bark of birch. The well known Danish glove-leather is also tanned with willow-bark. In Germany, little use has hitherto been made of willow-bark, probably on account of the small quantity grown.

Peelings from osiers are dried in loose heaps and used for tanning, or as litter for cattle.

Even the bark of the black alder is used for tanning, its contents in tannin varying from 8 to 20 per cent. (Eitner, Post, Counceler). In spite of its high percentage in tannin, the use of alder-bark is but limited; the tanning liquid decomposes rapidly, and the leather is hard and brittle, and of a dark colour.

Of foreign barks, that of the American red oak (*Quercus rubra*) is so poor in tannin that it is unsuited for bark coppice. The barks of Douglas-fir and hemlock-spruce are, however, very rich in tannin, so that even on this account their introduction to Europe is valuable.

SECTION IX.—CELLULOSE.

Cellulose from bark, either rhitidome or bast, resembles wood-cellulose in its constituents. Bast-cellulose is characterised by greater durability than the other cell-formations in bark, so that the bast-fibres may be separated by maceration. When they occur in clusters, owing to their toughness, they may be obtained almost pure by beating the bark. By twisting these bundles, they make excellent binding-material (hemp, flax). Even the fine fibres of the pod of the cotton-plant (*Gossypium*) consist of pure cellulose. These forms of cellulose are made into paper.

Among trees and shrubs, which contain utilisable cellulose in their bark, the following East Asiatic paper-shrubs may be cited: *Edgeworthia*, *Broussonetia*, *Wickströmia*, *Daphne*, *Skinimia*, etc. The first two are cultivated like osiers, and the cellulose in their bark made into paper.

For this purpose, the shoots are steamed, and the bark stripped from them and placed in water-tanks till all tissues except the bast-fibres have rotted. The cellulose is washed in water, finely divided and separated by fine sieves made of split bamboos, so that it forms a thin layer on the sieve. After the water has drained away, the thin sheets of paper are taken off the sieves and laid on planks to dry. Owing to this method of preparation, the cellulose fibres lie alongside of one another in the direction of the lines of meshes in the sieve, so that Japanese paper can be torn straight only in one direction and differs thus from paper made of wood or rags. The manufacture of this bark-paper is very important, for in Japan, paper is employed frequently in place of woven materials.

Species of limes contain useful cellulose in their bark, for the hard bast-bundles are grouped there tangentially, and a zone of bundles is formed yearly. As the soft bast lies between these bundles, they can be torn in strips from the bark. In order to obtain pure lime-bast, the bark must be macerated in water, till the softer tissues rot and the bast-bundles alone remain.

In central France, especially in Chantilly, there are lime-coppices for supplying bast, with rotations of 15 to 25 years. Also, in Russia, the lime is utilised for bast, which is stripped from the trees. It is made into coarsely woven material, into sacks, mats, protection coverings, etc., and is used also for binding, but for this purpose raffia-fibre is more suitable.

Species of elms also contain utilisable fibre.

SECTION X.—CORK.*

It has been stated already that cork is formed by a meristem, the cork-cambium or phellogen, but that for most woody species the cork is very thin and is soon displaced by rough bark, rhytidome. Only in very few species does cork attain a considerable thickness, by annual formations, resembling annual zones of wood. Where cork is only in ridges or prominences on the shoots or stem of a plant, its only use is ornamental (cork-elm, field-maple, *Xanthoxylon*, etc). When it

* Boppe, "Cours de technologie forestière," 1887. Mathey, "Exploitation commerciale des bois."

surrounds the whole stem and is not replaced by rhitidome, as in the cork-oaks of the westerly Mediterranean countries (south France, south Spain, Portugal, north Africa (including Tunis), Corsica, Italy, Sicily and Greece), a material is produced, which in its special qualities, elasticity, lightness, softness, durability, impenetrability by gases and spirituous liquids, can be replaced by nothing else.

Cork (suberin) is distinguished from wood by its higher contents of carbon and hydrogen; its chemical composition is:

| | | |
|---|-----|--------------|
| C | ... | 66 per cent. |
| H | ... | 8.5 " |
| O | ... | 22.8 " |
| N | ... | 1.9 " |

The thin-walled cells of cork do not consist entirely of suberin, but this substance is stored in large quantities in the fine skeleton of lignin and cellulose of their walls. Every wall common to two cells contains a lignified medial lamella, on both sides of which is a purely suberous layer, and on this, forming the innermost coating of the cell, is a thin lamella of cellulose. The layer of cork is the thickest of the three lamellae; only in thick-walled cork-cells (resembling late-wood and formed as late-cork in autumn), does lignin preponderate.

The two oaks (*Quercus Suber* and *Q. occidentalis*), in the countries already referred to, are subject to a regular system of management: the first layer of cork (**male cork**) is full of cracks, unevenness, impurities and stone-cells, and is therefore of little use. When the trees are about 20 years old this cork is removed by means of a sharp trimming-axe, so that the phellogen below is uninjured. Then the phellogen produces annually fresh fine layers of cork with visible annual rings. This useful, **female cork** is cut off in layers surrounding the stem and a meter long, every 8 to 10 years. In a young tree only the lowest section is removed, next time another higher section as well, and so on, till the boughs are reached and are also stripped of cork. In order not to endanger the life of a tree, eventually only one section is stripped in a year. The strips of cork are pressed flat and sold. Corks are cut from these strips, parallel to their length. Thin strips of cork are

CHAPTER II.

UTILIZATION OF THE FRUITS OF FOREST TREES.

Owing to the present great development of the artificial reproduction of trees, the harvesting and preparation of seeds is of special importance. This business is carried on extensively by seedsmen, whose enterprise is occupied chiefly in the collection and preparation of coniferous seeds.

It is proposed here to deal first with the characteristics of seeds, then with the conditions under which our most important forest-trees fructify. A number of factors determine the fertility of the trees, or the non-production of seed, and these require our careful consideration: such are the seasons of ripening and of the fall of seeds; methods of harvesting seeds and their subsequent preparation; storing seeds, estimating their value and selling them, for sowing, fodder, for making oil, etc.

SECTION I.—CHARACTERISTICS OF SEEDS.

The fruits of Oaks (*Quercus*), acorns, are borne on a *cupula*, or cup, that is composed of scale-leaves; the ripe acorn separates from its cup. In white oaks (*Q. pedunculata*, *Q. sessiliflora*, etc.), the acorn ripens in the year of flowering; with dark oaks (*Q. rubra*, *Q. Cerris*, etc.), in the year following the flowering; the seed is not fugitive.* The seed of Beech (*Fagus*) is triangular in section, with a leathery brown shell; there are usually two seeds, rarely only one, entirely enclosed in a *cupula*, which opens in four lappets; the husk of the fruit, when ripe, bursts in dry weather, so that the unfugitive seeds fall to the ground. The seed of the Ash (*Fraxinus*) is long

* The word *seed* is used here indifferently for seed or fruit, in accordance with economic usage. Winged seeds, or fruits, are blown by the wind, as is a parachute; they thus may reach a considerable distance from the parent trees; such seeds are termed *fugitive*, *flugfähig*, while heavy seeds are unfugitive, *unflugfähig*.

and flat; it broadens out at one end into a spatula-like wing; it is a fugitive samara, and may be blown off by dry east winds immediately after ripening, or later, in winter, by westerly winds. The seed of **Maples** (*Acer*) is a nut with a long stiff wing at one end; the seeds are united at their bases; they are blown from the trees by dry winds. The seed of **Hornbeams** (*Carpinus*) is a hard nut, surrounded by a tri-partite scale, and therefore winged; at first the seeds are removed from trees by the wind, later on by their own weight. The seeds of **Limes** (*Tilia*) are nuts, their stalks being united to a stiff, scale-leaf, which renders them fugitive, when the wind is strong.

In **Birches** (*Betula*), the little seeds with winged borders are samaras, attached with alternate tri-partite scales in catkins or cones, the segments of which fall (white birches), or the cones open (yellow birches), so that the seeds are released. They are blown to great distances by the wind. In **Alders** (*Alnus*), the scales of the cones are lignified and hard; they split when dry, and the small flat and scarcely fugitive seeds fall out.

In **Willows** (*Salix*) and **Poplars** (*Populus*), the hairy seeds are formed in a capsule, which bursts when ripe, so that the very fugitive seeds escape. In **Cherry-trees** (*Prunus*), species of **Pyrus** [such as *P. Aria*, whitebeam; *P. torminalis*, wild service-tree; *P. Aucuparia*, rowan; *P. Sorbus*, the true service-tree, and the wild pear, medlar, and crab-apple tree.—Tr.], the seeds are surrounded by a fleshy fruit; after the fruit has fallen, it decays and sets free the seed. The same is true for hawthorn seed (*Crataegus*).

Sweet-chestnut (*Castanea*) has a large seed, that is surrounded by a spiny cupula; either the entire fruit falls when ripe, or the seeds fall from the husk; the nuts of species of **Walnut** and **Hickory** (*Juglans* and *Hicoria*) are surrounded by green husks, which open on ripening.

The seeds of *Papilionaceae* (*Robinia*, *Gleditsia*, etc.) are enclosed in a pod; when this opens, the seeds fall to the ground, or the pods may fall with the seeds in them.

The seeds of **Spruces** (*Picea*) are formed in the axils of the scales of pendent cones; a few months after ripening the

scales open in dry weather, and the small brown seeds escape; the seed lying in a spoon-like depression of the wing is fugitive. The seeds of **Silver-firs** (*Abies*) and of **Cedars** (*Cedrus*) are free, as the upright cone breaks in pieces when ripe; the seed has a wing that is fixed to it firmly.

The seed of **Douglas fir** (*Pseudotsuga*) resembles that of spruce in its mode of formation and escape from the cone; it is fixed firmly to the wing, as in silver-fir. **Larch** seed (*Larix*) is formed in upright cones, so that when the latter are dry and open, the seed cannot escape by its own weight; a continued exposure to wind and rain, as well as to strong

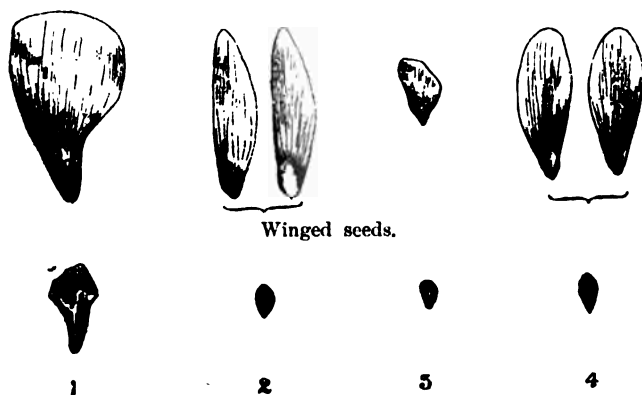

Seeds prepared for sale.

Fig. 360.

1. Silver-fir. 2. Scotch pine. 3. Larch. 4. Spruce.

(Drawn by R. S. Troup.)

gales, is required, in order to set it free from the cone (Weise), the little seed is attached firmly to its wing. In **Pines** (*Pinus*), cones of the section **Pinaster** open their scales a few months after ripening, in order to set free the seeds, which are encircled loosely by the lower ends of their wings. Pines of the section **Strobus**, Weymouth pines, possess a seed that is attached to the wing on one side only; **Cembran Pines** have only a stump of a wing on their seeds, which therefore is not fugitive; [the seeds of *Pinus Pinea*, *Cembroides*, *edulis*, *Monophylla* and *Gerardiana* are large and edible.—Tr.]; in all pines the seed ripens in the year after the flowering.

Cypresses, as well as *Thuja* and *Chamaecyparis*, form their small, slightly-winged seeds in little cones, or strobiles, the scales of which open soon after they ripen; in *Junipers* the scales have grown together into a berry; in *Yews* (*Taxus*) the nut-like seed is surrounded by a red, fleshy aril.

SECTION II.—DATES OF SEEDBEARING AND ITS REPETITION.

Usually woody species that have the lightest seeds are the earliest seedbearers: thus willows, poplars, birches, alders and elms are earliest, while oaks and beech are latest; between these extremes come the other broadleaved species. The larch among conifers has the earliest seeds, and has also the lightest of our coniferous seeds. Where *Thuja* and *Chamaecyparis* grow, they have the lightest of coniferous seeds, and normally produce seed from very young trees; silver-fir and Cembran pine have heavy seeds, and produce seed later in life. When the seeds of two or more species are of about equal weight, that which is light-demanding bears seed earliest; thus pines produce seed earlier than spruces, and oaks before beech.

Exposure to light also determines early seed-bearing; trees in the open bear seed 20 to 30 years earlier than the same species in a dense crop, the crowns of which are illuminated only at the top. Interruption of cover is therefore the best way of inducing a tree in a wood to bear seed. **Heat** is next to light the most important factor; in warm localities the same species bears seed earlier than in cool localities. A good soil, on which a tree grows rapidly, delays the production of seed, whilst bad soil, where the trees grow slowly, accelerates seed-bearing.

The grower of fruit-trees makes use of this latter property, by pruning the trees or by altering the conditions of the soil, in order to compel a tree to bear fruit early.

When the formation of fruit has commenced, it does not recur every year, but after definite intervals. R. Hartig has explained this periodicity of seed-bearing by the fact, that at the commencement of a seed-year, much of the reserve-material (starch) of the sapwood is dissolved, so that a number of years is required for replacing the starch; as soon as sufficient

starch has accumulated, another seed-year occurs. This apparently explains a number of phenomena in seedbearing. Thus the period of rest is shorter, the more favourable are the conditions of illumination for a tree; the more the crown is crowded and shaded, the longer is seedbearing delayed.

Increased exposure to heat expedites fructification; numerous prolonged observations in Prussia have proved this well-known law; Bernhardt, Weise, Hellwig, v. Alten and Schwappach* have shown this to be true.

Thus, in the warm Rhine provinces, there are good crops of acorns every two years, while in E. Prussia, only every six years. But for Scots pine, in Brandenburg every two years there is a good crop of seed, while in Rhenish Prussia and Silesia, only every ten years, so that the law is not true always, for age, soil, condition of crops, etc., must be considered as well as the effects of heat.

The following figures are generally true as regards the recurrence of seed-years for the same individual tree:—

| Recurrence of seed-years. | Species. |
|---------------------------|---|
| Every 2 years ... | Willow, poplar, birch, alder, cypress, elm, common pine, larch. |
| „ 2 to 4 years | Hornbeam, ash, maple, lime, spruce, |
| „ 4 to 6 „ | Silver-fir, Cembran pine, sweet-chestnut. |
| „ 6 to 10 „ | Oak, beech. |

According to this statement the lightest seeds are produced the most frequently, and this is a support of the truth of Hartig's theory. But it must be proved also how much reserve material is taken from the wood by a mast, and how much seed-albumen is formed in the particular seed-year. The weather during the seed-year decides also whether or not fruit is formed from the flower.

Acorn years are distinguished by great heat and drought (vintage-years); should two successive, dry, hot years occur,

* Schwappach, "Die Samenproduction der wichtigsten Waldholzarten in Preussen." Zeitsch. f. F. u Jagdwesen, 1895. A *resumé* of 20 years' observations.

oaks and other trees may fructify in both years, so that in the first year the reserve material is exhausted, but is replaced in the second year sufficiently for the tree to bear fruit. When late frost occurs in a year while the trees are blossoming, damp cold weather, or violent gales during pollination, the flowers may not fructify.

Good soil does not accelerate fruit-bearing, until the tree has attained the age of fertility; before this period it is poor soil, unsuitable for the species, that determines precocious and frequent fructification. All sickly individuals produce abundance of seed, although frequently this premature seed does not germinate.

As regards the **number of fertile seeds**, the light seeds come first, and the heavy seeds last, though often the eye of the forester is deceived about this when there is a good mast-year of oak or beech.

SECTION III.—DATES OF RIPENING AND FALL OF SEEDS.

The dates of ripening and fall of seeds depend chiefly on the heat of the locality, which expedites both of these operations; dry air also expedites them, but in general the following calendar is correct:—

RIPENING OF SEED.

| | May. | June. | July. | August. | September. | October. |
|-----------------------|------|-------|--------------------|---------|-------------------------------|--|
| First Half of Month. | — | Elm. | Willow. Poplar. | Birch. | — | Oak. Beech. Hornbeam. Alder. Ash. Maple. Larch. Pine. Thuya. Cypress. Douglas-fir. |
| Second Half of Month. | Elm. | — | Birch. | — | Oak. Maple. Silver-fir. | — |

FALL OF SEED.

| | Feb. | March. | April. | May. | June. | July. | Aug. | Oct. | Nov. | Dec. |
|-----------------------|----------------|------------------------------------|----------------------------|----------------|----------------|--------------------|--------|---|---------------------------------------|---------------------------------------|
| First Half of Month. | Alder. Ash. | Alder. Ash. Spruce. Pine. | Spruce. Pine. Larch. | Larch. | Elm. Larch. | Willow. Poplar. | Birch. | Oak. Beech. Silver-fr. | Maple. Lime. Ash. Horn-beam. | Ash. Horn-beam. Maple. Lime. |
| Second Half of Month. | Alder. Ash. | Spruce. Pine. Larch. | Larch. | Larch. Elm. | Elm. Larch. | Birch. | Birch. | Oak. Beech. Silver-fr. Thuja. Cypress. Chestnut. Walnut. Douglas-fr. | Maple. Lime. Ash. Horn-beam. | Ash. Alder. |

SECTION IV.—HARVESTING SEED.

The season for harvesting seed may be seen from the above tables, from which it is evident that certain seeds fall as soon as they ripen; fugitive seeds, such as birch, elm, and silver-fir, therefore, must be collected immediately before they ripen; this somewhat affects the quality of the seed, for ripening after collection is effected only in the larger seeds, or in seeds which remain in their fruit-husks (cones, cupulæ). The cones of spruce, pines and larch may be collected during several months.

The methods of harvesting may be understood from a consideration of the morphology of seed-production. By climbing trees with the help of climbing-irons, ladders, etc., and



Fig. 361.—Net and saw for collecting fruits. (After Fernandez.)

plucking the fruits by hand, or with shears, [or with a fruit net and saw (Fig. 361) which is used in India.—Tr.] the seeds of the following species should be gathered before they

fall: Birch, elm, ash, maple, hornbeam; also the cones of spruce, pine, silver-fir, larch, Douglas-fir, thuya, cypress and alder. By sweeping off the ground, after they have fallen, acorns, beech-mast, lime-seeds, cherries, species of *Pyrus*, chestnuts, walnuts, may be collected, and wherever fugitive seeds are heaped together by wind, or water (alder), they may be swept up and collected. It is a destructive measure to beat trees in order to cause the seeds to fall; the worst way is to collect seed from trees felled for the purpose, as is done in countries which have too much forest, or where economic forestry is not practised. The whole harvest is either leased, or given in contract by the forest-owner for his own requirements, or permits to collect seed given to poor people. It is for the manager to determine which method is the best financially and does least damage to the forest.

Fruits, seeds and twigs with the fruits attached to them, taken moist from the forest, must be dried superficially in places in the forest that are sheltered from rain, or under a roof. By sifting and picking over, the most obvious impurities are removed. The seeds of lime, hornbeam and birch are placed in sacks; by beating and shaking the sacks, the seeds are freed from their husks, and by winnowing, sieves, etc., they are separated from them. For heavy seeds, cleaning consists in the removal of all impurities and of fruits that are recognised as useless (shrivelled, perforated by insects, etc.)

Coniferous seeds require different treatment, for which a special industry, termed *seed-husking*, has been established.

SECTION V.—SEED-HUSKING ESTABLISHMENTS.

1. *Drying by Solar Heat.*

The cones of spruce and pines are dried by the sun in wire sieves placed in echelon one above the other, so that they all receive the full heat of the sun; portable boxes with wire sieve tops also are used. By shaking the sieves the seed falls on to cloths, or into boxes, placed below them, or in the latter case, into the boxes themselves.

The simplest method of employing solar heat is when the cones are placed on large cloths, laid on dry ground in full sun-light. Or sieves with double bottoms are used, that may be brought under cover in rainy weather. The seeds then can be separated easily from the cones by sieves, and this method yields the most germinative seeds. [In India and other hot countries, solar heat suffices for seed-husking.—Tr.]

2. *Seed-kilns.*

The essential conditions for all seed-kilns is, that the cones are exposed in them to artificial heat of 95°, 112°, or 140° F., and to air as dry as possible until all the cones are opened. The air is heated partly by stoves in the drying-chamber, or in a special heating-chamber from which it circulates into the former. Most of the German seed-husking establishments employ kilns.

Objection has been raised to kilns, that the seeds become too dry and lose their germinating power because they remain too long exposed to temperatures of 90° F. and more. This objection was justified by the defective construction of the earlier kilns, and by careless husking. The important improvements, that have more recently been introduced in seed-husking, have removed these objections completely.

In any kiln, that aspires to excellency, the seeds should not remain any longer exposed to the heat of the stove than is absolutely necessary for their removal from the cones.

Whenever the quantity of cones to be opened annually is not very considerable, and sufficient capital is not available for a large establishment, the simplest kind of seed-kiln will suffice. A spacious chamber, which can be suitably closed, containing a tiled Dutch stove, is then sufficient. Round the stove are stands, the upper portions of which support easily accessible wire-trays, or the cones are hung in nets from the ceiling. If the floor is paved, ventilators supplied at the four corners of the ceiling for the escape of the vapour from the cones and the heat regulated, good results may be expected.

If there is sufficient space, the stove may be enlarged into a

horse-shoe shaped heating-apparatus round the interior of the chamber and sometimes sunk partly into the floor. The stove must be made of brick-work, or trachite (*Bachstein*); otherwise a steady temperature is not obtainable.

When, however, hot air is admitted into the seed-kiln, an iron stove and hot-air pipes are placed in a heating-chamber, from which the hot air passes, as required, into the drying-chamber, being replaced by the admission of cool air. Most large seed-kilns are made on this principle. As the heating is effected more rapidly the more directly the stove communicates with the air, the apparatus is arranged generally so that the drying-chamber is traversed by a long series of hot-air pipes, which only after many convolutions communicate with the chimney of the stove.

Although all seed-husking establishments more or less follow the above plan, they differ from one another in their heating apparatus, arrangement of the gratings, etc., so that hardly any two of them are alike. They may, however, be arranged in groups, according as the wire-trays are moveable, fixed or cylindrical.

(a) **Moveable Trays.**—In this case, the light wooden frames of the trays are moveable and not too heavy for a man to lift easily: they are placed pretty close one above the other, generally on supports above the hot chamber. Thus they can be removed and replaced easily for changing the cones. Hundreds of these frames are used in large establishments.

Mr. Schott, a seed-merchant, of Aschaffenburg, has an establishment somewhat similar to that just described (Figs. 362, 363). *A* is the heating-chamber containing the convoluted iron pipes and surrounded by a thick masonry wall, which is pierced on two opposite sides by doors opening into the drying-chamber *B* through which the trays can be removed and fresh ones supplied. As both the heating- and drying- chambers are surrounded by the moderately cool air of the building, the heat is concentrated as much as possible. The stove is at (*a*), the smoke escaping through (*m*). The wooden trays (*h, h, h*) are provided with a base of thin wooden bars, except the lowest of them, which have fine wire-bottoms to prevent the seed from falling into the heating chamber.

Only a very inconsiderable portion of the seed, however, ever reaches these lowest trays; most of it remains on the upper trays, which are not shaken or disturbed in any way, until

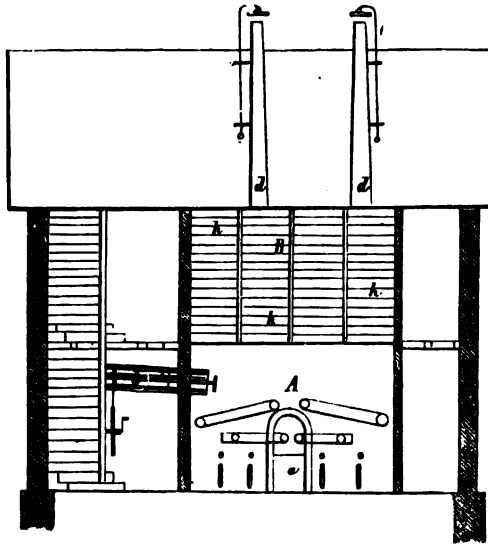

Fig. 362.—Section of seed-kiln.

they are removed. When once the cones are opened, the trays on which they lie are removed, and the cones shaken on to a

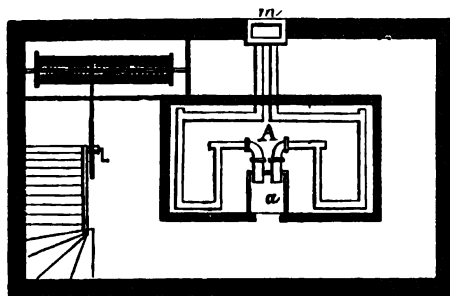

Fig. 363.—Ground-plan of kiln.

floor of wire-grating immediately above the revolving hollow sieve (b). The cones are raked up and down over this floor so that all the seed may be removed. The vapour from the cones escapes by means of shafts (d, d), which can be

closed if required; fresh air is supplied by the vent-holes (*o, o, o*).

This simple apparatus may be taken as a type of numerous private seed-husking establishments, as those of Geigle at Nagold, Keller and Appel at Darmstadt, Steiner's in Wiener-Neustadt, etc. The frames supporting the trays are made of

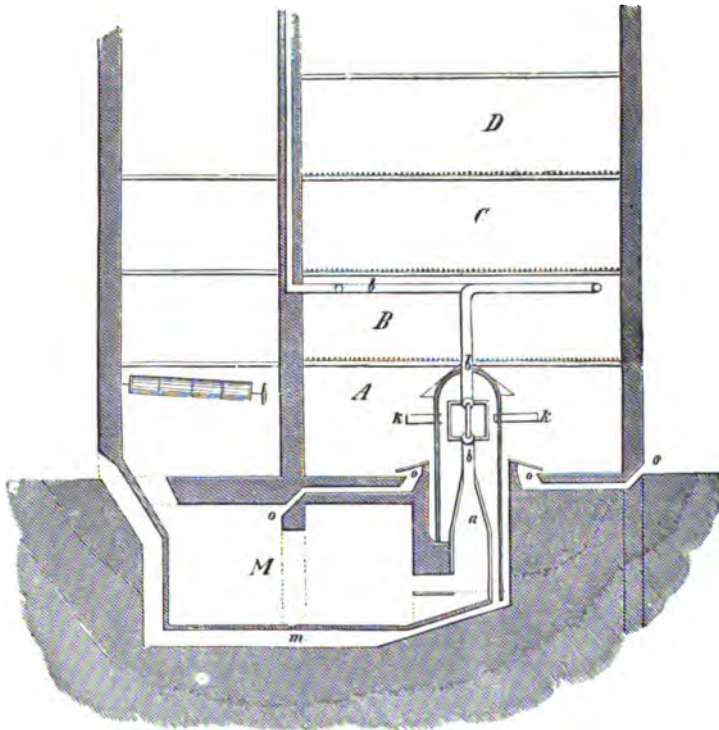
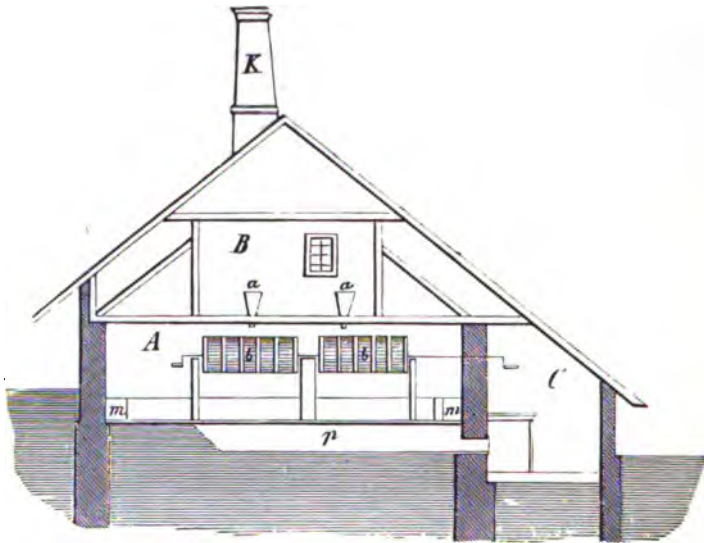

Fig. 364.—Seed-kiln with fixed trays.

iron; four large stoves in the lower story supply the hot air. Numerous openings with valves regulate the temperature.

(b) **Fixed Trays.**—Fixed trays are used in buildings with several storeys; the heating-apparatus being on the ground-floor, above which are two or more drying-chambers. The floor of each of these is of grating (in the newest establishments of the kind, of thick iron wire, in the older ones of wooden bars), but close enough to allow only the seed and not



(Elevation.)

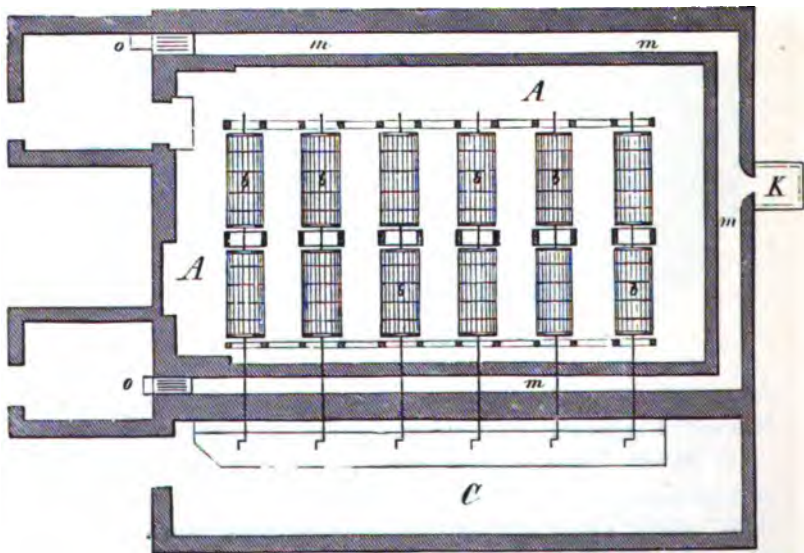

(Plan.)

Fig. 365.—Seed-husking establishment with drum-sieves.

the cones to pass. The cones are piled a foot deep on the gratings and are stirred constantly so that they part with all their seeds. The seed falls into the seed-chamber on to a paved floor kept cool by the admission of cold air, and from this it is removed.

This method is adopted by (Fig. 364) Steingässer at Miltenberg, Schultze and Pfeil in Rathenoer, etc. The stove (*a*) in an underground room, *M*, the upper part of which leads into a system of pipes (*b, b*) and is surrounded by a cupolaed frame of trachyte which passes into the seed-room *A*, and allows the contained hot air to escape through several long tubes (*k, k*) and numerous openings. The channel (*m*) admits cool air and (*o, o*) are ventilating tubes arranged so as to keep the paved floor cool. *B, C*, and *D* are drying-chambers.

(c) **Drum-sieves.** — Apparatus with drum-sieves differ completely from those described above, and are used in many places in Silesia, Hanover, Mecklenburg, etc. (Fig. 365).

Then the hot air is supplied by means of closed pipes (*m, m, m*) made of trachyte and closed with iron valves, which are situated beneath the drying-chamber. The heating is by stoves (*o, o, o*), that opens into (*m, m*); the vapour escapes by the chimney (*k*). The cones are supplied from the floor of a loft *B*, passing through the funnels (*a, a*) into the drums (*b, b*), which revolve in pairs on a common axle; they are turned by handles in the room *C* so that the seeds may fall through as soon as the cones have opened. The drum-sieves are of wood, or iron, in the former case with wooden gratings secured by several iron hoops. Each drum can be opened (Fig. 366) in order to insert and remove the cones; under each pair of drum-sieves is a masonry or concrete trench (*p*) into which the seed falls, and from which it is removed by

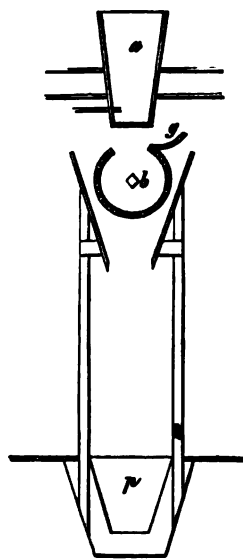

Fig. 366.

wooden scrapers to the chamber *C*, into which the trenches lead. After all the seeds have been removed, the drums are opened downwards and the empty cones removed by the same means as the seed. The drums are turned at intervals of a quarter of an hour, so that the seed soon falls into the cool trenches and being at once removed is not exposed to the hot air longer than is absolutely necessary. This rapid action allows much greater heat to be applied to the cones than in other establishments; recent experience, however, shows that they are not more effective than the latter, which on the whole are preferable. Drum-sieves are used in Blankenburg by Conrad Trumpf, and at Carolath in Silesia.

3. Separation of Seed from the Cones by Steam.

Cones are opened by steam, when the air round the trays in which they are placed is heated by means of condensed steam. Steam from a boiler outside the seed-kiln is supplied in pipes running under the trays, it then becomes condensed owing to the comparative coolness of the chamber containing the trays. The steam-pressure being then considerably increased, the heat acquired in the boiler is radiated into the drying-chamber by the pipes. In order to increase the heating effect of the pipes, their surface is considerably increased by conducting them repeatedly up and down the drying-chamber.

The three well-known wholesale seed-establishments of Keller, Appel and Le Coq at Darmstadt, have been working successfully on this system for many years. The first of these seed-kilns was burnt in 1865, and up to that time there were three tiers of piping under all the trays. This, however, did not heat the air sufficiently; in the new works erected therefore, two tiers of piping were placed under the trays, and the other tier moved higher up between them. This gives excellent results. The pipes are of wrought iron and are 200 meters long, with an exposed surface of 87 square meters. The boiler is in a detached house, and also serves to drive machinery used in separating seed from larch-cones; it supplies steam for heating the pipes and the resulting condensed water flows back into the boiler.

The advantages of steam drying over hot air drying are, as follows :—

There is no fear of a conflagration in the seed-kiln ; by means of in and out draughts, heat can be supplied according to requirements, and the amount necessary for opening the cones is attained in one-quarter of the time required by the hot air apparatus, whilst the whole time occupied by the process is shortened by one-quarter ; the temperature cannot exceed 133° F., so that there is no danger of over-heating the seed. Keller's process gives from 87 to 97 per cent. of germinating seeds, which, according to Braun, are not only considerably superior in germinative power to seeds from hot air kilns, but also can be kept longer.

4. Management of Seed-husking Works.

The system followed in the different seed-husking establishments is of a simple nature. The cones from the store-house are placed in sacks or otherwise brought to the seed-kiln and placed on the trays. After the heat has been applied and the cones begin to steam, all vent-holes must be opened. As soon as the air becomes drier and the cones have been exposed for some time to the heat, they begin to open. Generally this does not happen simultaneously on all the trays ; the current of hot air is then turned in the direction of the backward trays by opening certain vent-holes, or changing the places of those trays with those where the cones have opened and thus exposing them to the hottest blast.

Management of the heat is the most important point in the kilns. The heat should rise as uniformly and quickly as possible to the temperature most suitable for the apparatus and cone in question. Scots pine cones require the greatest heat, usually 90° to 125° F. ; spruce 80° to 90° F. ; Weymouth-pine and alder, 60° to 70° F.

In order to guard against over-heating by the workmen, Keller, in Darmstadt, has an electric bell in his office communicating with a metallic maximum thermometer in the kiln.

The cones on removal from the trays are thrown usually on to a grating so that the seeds may be separated from them ;

they then always retain a few seeds and in order to secure these, they are placed in a drum-sieve (Fig. 366, *b*), which is made to rotate.

This consists of a cylinder with wire sides, open at both ends, and there are often projecting bars fastened here and there to its axle inside the cylinder which assist in shaking the cones. It is turned slowly by means of a pulley and belt. The cones are poured into the drum-sieve through a hopper and are so thoroughly shaken within it, as to part with all their seeds. The seeds fall on to the floor and the empty cones pass out at one end of the drum-sieve, which is slightly inclined in that direction, through a second funnel, into the store-room for empty cones.

Removal of the wings of Scots pine and spruce seed may be effected in various ways. On a small scale, and if it is considered sufficient to remove the greater part of the wing, leaving a small fragment attached to the seed, the **dry process** is employed. In this case linen sacks are half filled with seed (the mouth of each sack being tied) and beaten with light flails, being turned and shaken and rubbed until the wings are removed. In wholesale establishments a different method is usually employed, termed the **wet process**, which gives quicker results. The seed is then piled 6 to 8 inches high on a paved or planked floor, sprinkled lightly with water from the rose of a watering-pot and then beaten energetically with leather flails. In many seed-depots hardly any water is used and yet the wings are removed completely. Newer methods are; to pass the seeds between two rotating stones, or to place them in a drum with revolving brushes (*détacheur*).

In order to obtain clean silver-fir seed, more trouble must be taken. The moistened seed then generally must be heated, so that very clean silver-fir seed is regarded with suspicion.

Frequently objection is made to the wet process, that it prejudices the germinative power of the seed. This objection is justified, if the damp seed is kept in heaps and allowed to ferment, so that the wings may separate from the seed without any further mechanical treatment. If, however, the method already described is followed and no fermentation allowed, the

damping being merely auxiliary to the threshing, clean seed with good germinative power is obtained.

Once the wings have been severed from the seed, they must be removed in order to obtain clean seed. This is effected either by swinging the seed on a wooden tray, or tossing it with a wooden winnowing-shovel, which removes both the wings and light worthless seeds. As a rule, however, the seeds are placed in a modern corn-sifter, provided with several graduated fine wire-sieves. This separates all impurities and the worthless seeds completely from the good seed, the workman being careful to turn the machine slowly. Special cleaning machines worked by motor-power are the best.

5. Separation of Seeds from Larch Cones.

The method described in 2, refers only to Scots pine and spruce; it is not applicable to larch cones, which cannot be completely freed of seed by artificial heat without damaging its germinative power. Only the upper part of larch cones opens when subjected to heat, the base of the cones, which contains most of the seeds, remaining closed. Larch cones must therefore be torn open in machines, clean seed being obtained only after much troublesome manipulation.

Much larch seed is exported regularly from the Tyrol. In order to remove the seed, little water-wheels are suspended in the rapid torrents, on the axles of which are rapidly rotating tin cylinders. The cones enclosed in these cylinders are rubbed violently against one another, and the seed set free. In order to remove the last seeds from the cones, the latter are pounded. One of the best stores for Tyrolese larch seed is that of Jennewein, at Innsbruck.

[In French Savoy and Dauphiny, larch seed is collected by peasants between December and February; during the prevalence of the comparatively warm south wind, the cones drop their seeds on to cloths spread under the trees on the snow. This seed is said to germinate much better than that purchased from seed-establishments.—Boppe.]

The apparatus employed by Appel, at Darmstadt, which resembles that used by the Tyrolese, consists of wooden

drums, which are driven by steam and made to rotate rapidly on their axles. Their internal surface, as shown in Fig. 367, is covered with little sharp, projecting cones, against which the larch cones are rubbed, but the mutual friction between the cones is more effective than the action of the internal surface of the drums.

Apparatus worked by steam for opening larch cones is based generally on a continual friction between their scales, and consequent removal of the seed without injuring it. That used by Keller at Darmstadt consists of a hollow wooden drum (Fig. 367), which is fixed firmly in a vertical position,

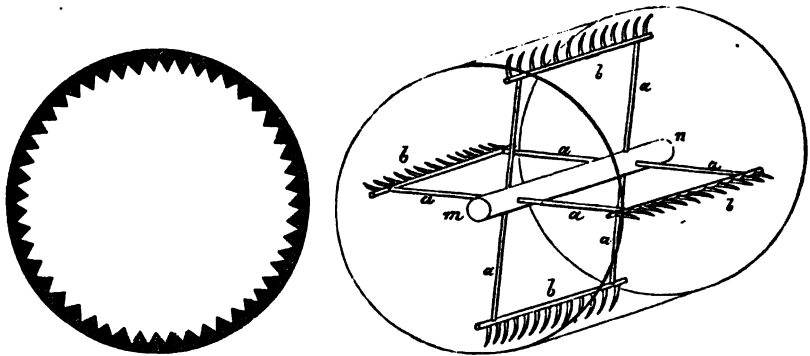

Fig. 367.—Drums for husking larch-cones.

and at its axis is an iron rod provided with four arms *a*, which support four closely-toothed iron rakes *b*, parallel to the internal surface of the drum. This revolves rapidly on its axle *m n*, larch cones supplied from above are rubbed together so thoroughly and to a certain extent torn to pieces, that they part with all their seed that collects at the bottom of the drum, from which it is then removed.

The sides of this drum are composed of plates of iron, which are not quite juxtaposed, finer refuse therefore escapes through the slits between them. Under the drum large sieves are kept in constant motion backwards and forwards. This apparatus of Keller's is preferable to all others yet invented, as it removes the seed in less than half the time taken, for instance, by the Tyrolese method.

Larch-seed, when freed from the cones, is mixed with pieces of wood and scales of various sizes, and any amount of dust, from which it must be cleaned. The sifting process is therefore tedious and the workmen must show much patience. The seed is separated from refuse either by means of hand-sieves, or by fly-wheels, or by placing it on water in a tub; the pieces of wood and scales sink to the bottom, whilst the seeds float on the surface and are then scooped off and dried, the dried seeds finally passing through a corn-sifter.

In Keller's seed-depot a small mill is used for removing the wings from larch-seed, the grinders being made of vulcanised caoutchouc and as far apart as the length of the seeds; thus the wings are removed by friction. A fly-wheel working under the exit-funnel separates thoroughly the wings, dust and worthless seed, from the good seed.

6. *Husking Silver-fir Cones, etc.*

The cones of silver-fir usually fall to pieces on their way to the seed-husking establishment; the seeds are separated from the large cone-scales by sieves. The wings are united to the seeds and are removed by friction, or by trampling or beating them in sacks. Similarly the seeds of Douglas-fir, Douglas and Weymouth pines are cleaned. The cones of thuyas and cypresses open readily when exposed to the sun, and the little seeds are sifted free from the scales.

7. *Net Yield of Seed.*

The net yield of seed obtained from a certain quantity of cones depends on several circumstances. The system of husking followed is most decisive in this respect; then the condition of the cones (whether harvested in autumn, mid-winter, or in dry, spring weather, after some of the seeds have left the cones). The size of the cones and the number of seeds they contain vary in different years, for in really good seed-years cones are often smaller than usual and yet contain more than the usual number of seeds. Lastly, the

method employed for removing the wings, and the comparative thoroughness with which this is done, affects the yield greatly.

It is not, therefore, surprising that the yield of different seed establishments in different years should vary considerably. The following table gives the average weight of different quantities of cones and seed:—

| Species. | Weight of fresh cones. | | Weight of sifted seed from— | | Weight of sifted seed. | |
|------------|------------------------|-------------|-----------------------------|--------------------|------------------------|--------------|
| | 100 liters. | One bushel. | 100 liters of cones. | 1 bushel of cones. | 1 liter. | 1 quart. |
| | kg. | lb. | kg. | lb. | grams. | lb. |
| Scots pine | 50 to 55 | 40 to 44 | 0·75 to 0·90 | ·60 to ·72 | 500 to 510 | ·96 to ·98 |
| Spruce ... | 25 to 30 | 20 to 24 | 1·23 to 1·70 | ·98 to 1·36 | 560 to 370 | 1·08 to 1·09 |
| Larch ... | 36 | 29 | 1·80 to 2·70 | 1·44 to 2·16 | 500 to 510 | ·96 to ·98 |
| Silver-fir | 25 to 30 | 20 to 24 | 1·50 to 2·25 | 1·20 to 1·80 | 300 to 410 | ·58 to ·79 |

The concluding table gives the weight of sifted seed, without wings, of the different species obtained from a certain weight of winged seed, and the number of seeds in a fixed weight of sifted seed.

| Species. | Weight of sifted seeds. | | Average number of seeds.* | |
|----------------------|-------------------------------|----------------------------|---------------------------|----------|
| | from 1 kilog. of winged seed. | from 1 lb. of winged seed. | in 1 kilog. | in 1 lb. |
| | kg. | oz. | | |
| Spruce | 0·55 | 9·6 | 120,000 | 54,500 |
| Silver-fir | — | — | 22,000 | 10,000 |
| Larch | 0·80 | 12·8 | 165,000 | 75,000 |
| Scots pine | 0·70 | 11·2 | 150,000 | 68,000 |
| Black pine | 0·80 | 12·8 | 48,500 | 22,000 |
| Mountain pine | 9·75 | 12·0 | 125,000 | 56,700 |
| Weymouth pine | 0·50 | 8·0 | 61,000 | 27,700 |

The size of the cones, and the consequent size of the seeds, as well as the number of seeds in each cone, vary with the climate, for greater heat implies larger cones and seeds; thus Cieslar found:

In Finland, 1000 seeds of spruce weigh 3·96—4·569.

In S. Sweden, " " " 5·00—5·60.

In Germany, " " " 7·59—8·60.

* [Figures for Scots pine, spruce and silver-fir from Gayer, the other pines from Mr. Appel of Darmstadt, larch from Dr. Schlich.—Tr.]

Good soil has a similar influence on the seed: seeds from trees grown in gardens usually are larger than those from forest trees; at the commencement of fertility also the seeds are larger than those from old trees, and the power of producing seed is lost gradually by the latter. There are also variations in the size of seeds in individual trees, even the seeds in any cone vary in size and weight.

SECTION VI.—STORING THE SEEDS OF FOREST TREES.

1. *General Account.*

Silviculture shows that it is often advantageous to delay sowing seed until the spring of the year after it has ripened. Seed must therefore be stored for this purpose, and if this can be done without impairing its germinative power seriously, the forester becomes to a certain extent independent of the occurrence of seed-years.

In general, seeds with an embryo or albumen rich in starch do not preserve their germinative power so well as those which contain much oil or turpentine. For under their closed husks, provided water is excluded, oxidation of oil is much slower than conversion of starch into gum, dextrin and sugar.

Germinative power is lost quickly in **acorns***, **chestnuts** and **beech-nuts**, so that these fruits very rarely can be kept for more than one winter. The same rule applies to seeds of **birch**, **elms**, **silver-fir** and **alder**, which soon become mouldy unless stored very carefully. Seed of **ash**, **hornbeam**, **lime** and **Cembra pine**, most of which germinates only in the second spring, can be stored easily. [In the case of **Weymouth-pine** also, much seed does not germinate till the second spring.—Tr.] **Lime-seed** can be kept good for 2 or 3 years, but owing to the abundance of seed produced almost every year there is no necessity to store it. Germinative power is longest preserved in the seed of **larch**, **Scots pine** and **spruce**, and experience has shown that if carefully stored, **larch-seed** may preserve its germinative power 2 to 3 years; **Scots pine seed** 3 to 4 years, and **spruce-seed** 4 to 6 years.

As during winter, slow chemical changes preparatory to

* More quickly in sessile than in pedunculate acorns.

germination proceed in seeds, the temperature must be kept down, provided it does not descend much below freezing point, so that by over-heating, seeds may not germinate or be killed. Too much moisture involves danger from fungi and rot, too much desiccation causes loss of the power of germination. Seeds also must be preserved against injuries of every kind, by mice, insects, &c.

The usual methods of storing seed will now be described :

2. *Storing in heaps in the Open Air.*

This method is applicable for beech-nuts, acorns, and chestnuts. A dry site near a forester's house, with loose, sandy soil for choice, is cleared completely of all vegetable matter, and the fruits are mixed with plenty of sand and placed in heaps on the ground. The more delicate the fruit, the lower the heaps. The heaps are covered with dead leaves or straw, at first only moderately thick, and some bundles of straw are stuck through the covering to afford ventilation. As the weather becomes colder, earth may be thrown on the covering, but it should be remembered always that seeds are less sensitive to cold than to heat. At the close of winter the covering should be removed gradually in the same way as it was supplied, for it is extremely probable that the destruction of seeds kept over winter is often due to delay in removing their covering.

3. *Storing in Trenches.*

Acorns, beech-nuts, chestnuts and the fruits of ash and hornbeam may be stored in trenches in the open air. The trenches for acorns should be about half a meter ($1\frac{1}{2}$ feet) deep, with vertical walls and in long rows; beech-nuts are placed in wider, but shallow, trenches not deeper than 30 centimeters (1 foot); ash, hornbeam and sycamore seed in narrow trenches like drills; these seeds should remain for two winters in the trenches, and be sown only in the second spring. When there is only a small quantity of slowly germinating seed, such as nuts of the black walnut, it may be mixed with sand in earthenware pots, which are placed in the

ground. It has also proved useful to mix ashes with sycamore, ash and other seed, in a cask placed in a dry, well-ventilated locality.

4. *Storing on Ridges under Thatch.*

In this method after the seed has been fairly dried, it is placed on long ridges raised about 8 inches or a foot (20 to 30 centimeters) above the ground under a light thatch of straw or dead leaves. Or a flat place may be slightly excavated in the ground and covered by a thatched roof high enough to allow a man to inspect the seed. Then the seed can be turned, and its covering modified according to changes of temperature, which is a great advantage.

This method is applicable to acorns of both species of oak, and beech-nuts, the seed being mixed with sand as before. By altering the thickness of the thatch and turning the acorns, they are protected against frost and over-heating. Beech-nuts require a cool, damp place, and the ground should be watered for them during very dry weather: they are fairly hardy against frost, and well-ventilated places suit them, which may be paved with stones. When thus kept, however, they must be turned and watered regularly.

5. *Storing in Rooms.*

Sacks of acorns and chestnuts may be kept in cellars, only when the latter are sufficiently dry and well-ventilated.

Several other kinds of seed, such as that of silver-fir, may be kept in rooms. In a room free from frost, or at any rate, from low degrees of temperature, silver-fir seed mixed with the scales of the cones may be placed on shelves, either alone, or with saw-dust. The windows must at first be kept open in order to dry the seed, and the latter turned from time to time. This is absolutely necessary for silver-fir seed, which is very liable to become mouldy. It is best kept in the cones, but they can only with great difficulty be kept entire through the winter.

Dried seed of the birch or alder may be placed in sacks and these suspended in dry rooms. If twigs have been cut with the fruit, they may be tied in small bundles and suspended as

The best German firms sell seed with the following percentages of germinating power :—

| | | | | |
|-------------------|-----------|---|-----------|----------|
| Acorns | . | } | | 55 to 65 |
| Beech-nuts | . | | | |
| Chestnuts | . | | | |
| Maples | . | | | |
| Limes | . | | | |
| Robinia | . | | | |
| Elm | | | | 40 to 50 |
| Alder | | | | 30 to 40 |
| Birch | | | | 20 to 30 |
| Willow and poplar | | | | 5 to 10 |

For coniferous seeds, the Swiss Control Station gave the following results :—

| | | |
|---------------|-----------|--------------|
| Cembran pine | | 85 per cent. |
| Spruce | | 68 „ |
| Scots pine | | 65 „ |
| Black „ | | 63 „ |
| Weymouth pine | | 55 „ |
| Douglas-fir | | 48 „ |
| Larch | | 38 „ |
| Silver-fir | | 27 „ |

Seed-dealers supply seed, the quality of which varies in different years :—

| | | |
|-------------------------|-----------|--------------------|
| Spruce | | 75 to 80 per cent. |
| Scots pine | | 70 to 75 „ |
| Weymouth and black pine | | 65 to 70 „ |
| Silver-fir | | 55 to 65 „ |
| Cembran pine | | 40 to 50 „ |
| Larch | | 30 to 40 „ |

SECTION VIII.—SALE AND DISPOSAL OF SEEDS.

Seeds are sold partly by weight and partly by volume ; it is desirable that both these measures should be used, but they imply no guarantee that the seed is fresh or possesses good

germinating power. The following statement compares the measures and weight of seeds in litres and kilograms. [1 bushel contains 96½ litres and 1 kilo = 2·2 lbs.—Tr.]

| | |
|-----------------------------------|---------------------------------|
| Acorns (1 l. weigh 0·75 k. | 1 k. contains 270 to 300 seeds. |
| Beechnuts 0·45 .. " | 4 .. 4½ thousand seeds. |
| Ash 0·15 .. " | 13 .. 14 .. " |
| Sycamore 0·13 .. " | 11 .. 12 .. " |
| Elm 0·05 .. " | 100 .. 140 .. " |
| Cembra pine 0·50 .. " | 3½ .. 5 .. " |
| Weymouth pine 0·40 .. " | 55 .. 65 .. " |
| Scots pine 0·50 .. " | 150 .. 170 .. " |
| Spruce 0·45 .. " | 120 .. 150 .. " |
| Larch 0·45 .. " | 140 .. 170 .. " |
| Silver-fir 0·40 .. " | 20 .. 24 .. " |
| Douglas-fir 0·40 .. " | 87 " |
| Lawson's Cypress 0·23 .. " | 500 seeds. .. " |

Seeds are transported in sacks, or bags; recently in sheet-iron cylindrical boxes.

As regards the price of seeds, the following statement was prepared by Laspeyres for Prussia, from 1880-1895:—

| | Marks. |
|----------------------------------|--------|
| 1 hectolitre of acorns | 15·76 |
| 1 ,, beechnuts | 21·86 |
| 1 kilo black alder | 0·86 |
| 1 ,, white alder | 1·62 |
| 1 ,, birch | 0·60 |
| 1 ,, Scots pine | 4·45 |
| 1 ,, spruce | 1·73 |
| 1 ,, larch | 2·43 |
| 1 ,, silver-fir | 0·75 |

The price of Scots pine seed varied between 3·05 and 8·10 marks.

| | Marks. |
|----------------------|---------------|
| Spruce | 1·05 and 3·40 |
| Larch | 1·18 ,, 6·87 |
| Silver-fir | 0·88 ,, 1·67 |

[A hectolitre is about 3 bushels and a mark is equivalent to a shilling.—Tr.]

There were no beechnuts and no sessile acorns for 6 years, the other seeds were procurable every year.

Forest seeds are used almost exclusively for raising plants ; for other commercial purposes, only a fraction of the seeds are employed. Beechnuts are used for preparing salad oil.

Thus in the Forêt de Retz, in 1898, salad oil valued at £6,000 was obtained from beechnuts, besides 300 bushels of seed being sent to other State forests and sufficient seed reserved to restock the felling-areas. An acre of beech 100 years old produces about 20 bushels of clean nuts, worth 2s. a bushel, from which 100 lbs. of oil can be made, the nuts containing 15 to 17 per cent. of oil. The nuts are swept up from under the trees, sifted, sorted, dusted and dried slowly ; cold pressure is applied to extract the oil.—Tr.]

In forests, where chestnuts, walnuts, hazelnuts are produced, the production of the nuts may surpass in value that of the timber.

Formerly **pannage**, in which acorns, beech and other seeds were eaten in the forest by pigs, was carried on extensively in European forests. This mast of fruits was distinguished from **earth-mast**, in which worms, larvæ and pupæ of insects, fungi, roots of weeds, etc, were utilised. **Full-mast** gave enough acorns, etc., to fatten the pigs ; this required 66 days feeding, when every pig ate daily 12 litres of acorns or 16 litres of beechnuts. **Half-mast** sufficed to feed the pigs, without fattening them. Owing to the rarity of seed-years and the damage done to young crops by the pigs, also to danger from swine fever, when pigs are admitted promiscuously into a forest, pannage has now become rare. When there is a plentiful seed-year, it may be leased, or given as a privilege to poor people. The question, whether the admission of pigs may be silviculturally beneficial, by breaking up too dense a layer of dead leaves and moss and exposing the mineral soil in woods ready for natural regeneration, also for destroying mice and insect-larvæ, can be decided only for certain localities.

[In the New Forest, in a good mast year about 5,000 swine are admitted. Near Windsor acorns are collected in baskets and sold at 1s. per bushel to farmers for feeding pigs.—Tr.]

CHAPTER III.

UTILIZATION OF LEAVES, TWIGS AND ROOTS OF TREES.

ACCORDING to Ebermayer, Weber, Ramann, Councler, Emeis and others, leaves and twigs contain large quantities of nitrogenous compounds, carbohydrates and mineral salts. In using twigs and leaves for fodder* the above represent the actual nutritive value of these plant-parts, for the cell-walls are usually indigestible. These substances are most abundant at the season when the buds are opening and the leaves unfolding; at the close of the growing-season, most of them return into the permanent shoots, as reserve-material. The nutritive value of leaves and twigs, therefore, depends chiefly on the season at which they are utilised; fallen leaves are so unnutritious, as to be fit only for litter. [At the same time, in evergreen broadleaved trees, nutriment is stored during winter in the foliage and twigs, as such trees as *Quercus dilatata*, *Prunus Puddum*, etc., are lopped regularly in the Himalayas, for winter-fodder.—Tr.] In leafless trees, the yearling shoots are most nutritive; branches become less nutritive, the thicker they are; those 1 to 2 c.m. thick have hardly any value as fodder. Species that are most exposed in forest-pasture to the bite of cattle, supply the best fodder; ash, poplars, willows (especially *Salix alba*, *Caprea*, *vitellina*, *pentandra*), limes, maples and oaks, are good; beech and elms yield good fodder, as long as the leaves are young; the Canadian poplar is said to yield the best fodder. Among conifers, the silver-fir is best, but the spruce also is lopped for fodder, the larch least of all. The species of cattle should be considered also; for sheep and goats eat all leaves, while horned cattle are more particular.

* Dimitz, "Futterlaub u. Futterreisig." Zentralblatt f. d. ges. Forstwesen. 1894.

It is calculated, that 150 lbs. of leaf-fodder without twigs, 125 lbs. with twigs, are equivalent to 100 lbs. of moderately good hay. Grandeau found that the dry substance of yearling twigs without leaves, and of hay, had the following composition :

| | Beech. | Oak. | Hay. |
|----------------------------|--------|-------|-------|
| Protein | 11·08 | 14·40 | 11·10 |
| Oil | 1·30 | 2·97 | 2·70 |
| Fibres | 84·15 | 90·14 | 8·60 |
| Extract without nitrogen . | 49·32 | 47·64 | 47·20 |
| Ashes | 4·15 | 4·85 | 7·40 |

According to the researches of the Agricultural Academy at Bonn, twig-fodder is useless for farm-horses; ruminants thrive better on it, sheep best of all. Birch twigs are best, then beech; hornbeam is worst. Green twigs are always better than dry twigs: the valuable parts of the twigs for fodder are their bark and buds; only in years when fodder is scarce, can twigs be considered as a substitute for hay or straw. Ramann and Lawe's experiments to chop up twigs by machinery for fodder has proved unsuccessful.

In evergreen conifers the twigs are more valuable as litter than as fodder. The toughness of roots prevents their use as fodder. The injurious utilization of leaves and twigs is secured in various ways; there are country districts, especially in warm countries outside Germany, in which regular coppices of broadleaved species, similar to osier-beds, with 1 to 2 years' rotation, are maintained expressly for fodder; in others, pollards are used, or trees are lopped for the purpose. The most harmful form of this usage is when young saplings in coppice, coppice-with-standards and high forest, are lopped; the utilisation of leaves and twigs from trees felled in the ordinary way alone can be recommended (Neumeister). The instruments used are knives, billhooks, hatchets, or shears for small pieces.

Leaves and twigs serve for feeding domestic animals, more rarely for deer; sheep and goats, less frequently cattle and horses, are fed with either green or dried material. Only in

countries where meadows are scarce, as in those adjoining the Mediterranean Sea, or where the peasantry is poor, and land much subdivided, is leaf-fodder important; also in years of general scarcity of fodder, as in 1898. Except in such cases, the usage of leaf-fodder should be banished from forests. In countries where rice is cultivated, young leaves and twigs are stamped into the inundated fields to serve as manure (Japan). [Also in India, for rice-nurseries, under the well-known name of *rab*.—Tr.] Twigs of both broadleaved and coniferous trees are used, in the cultivation of flowers and vegetables, as a shelter against insolation and frost, also in forest-nurseries. Branches, with autumnal coloured foliage, or with coloured fruits, or coniferous branches with cones, are used for decorative purposes.

From the needles of pines, spruce and silver-fir, oil is distilled; wood-wool, said to be made from pine-needles, is made of sea-grass (see Part III).

The branches of conifers are employed extensively as litter.

Green litter is obtained from standing trees, either from the ground by dragging down the branches, or by climbing the trees and lopping them; or by using the litter from felled trees.

The most destructive method is practised in the Tyrolese and Swiss Alps. Iron hooks on long poles are used for pulling down and breaking off the branches. In other countries the men climb the trees with the help of climbing-irons and lop the branches with a hatchet. Where the future of the forest is cared for, only stems that will soon be felled according to a working-plan are lopped from the base upwards, in the course of a few years. If no care is taken of the forest, trees are lopped frequently of all their branches up to the leader. The simplest and least harmful practice is to lop the branches from felled trees in the regular felling-areas.

The branches thus obtained usually are carted to the farm-yards, and cut into small pieces on a block with a sharp hatchet; all the wood that is more than a finger thick is set aside for fire-wood and the remainder used for litter. If the branches from a regular felling-area are to be used for litter, the workman takes each branch and cuts off the twigs covered with needles,

before he cuts the wood into lengths with a billhook or an old sabre, and binds them up into faggots.

The quantity of utilisable needle-litter depends on the species of tree, the system of management, the method of utilisation and age of the tree. Silver-fir and spruce yield more litter than do pines. Pines subdivide their crowns into boughs, while silver-fir and spruce have only one subdivision of their branches, so that besides possessing fewer needles, there are many branches in pines that are too thick for litter.

Silver-firs and spruces also have many little branches on their boles, that are absent in pines. As regards the system of management, the more open selection forest produces more litter than does even-aged high forest. The use of branch-litter is practised usually wherever selection forests prevail, as in the Tyrolese and Swiss Alps, private forests in the Fichtelgebirge, the Franconian Forest and Schwarzwald in Wurtemberg, etc.

Many Alpine forests are so impoverished by the utilisation of branch litter, that they are no longer able to satisfy moderate demands for this material. In the forests of Franconia and the Fichtelgebirge, and in many parts of the Schwarzwald, every woodcutter by moderate lopping has obtained for generations about 1 to 1½ waggon-loads of branch-litter per acre annually, from the selection forests, without any fear of the supply being reduced.

As regards the age of the trees that are lopped, it is evident that in pole-woods, the power of reproducing branches after lopping is the greatest, and that the older the trees, the fewer small branches are available.

Reduction in the yield of a forest occurs only when the trees are lopped extensively up to their crowns; it is however certain, that, owing to the formation of occluding lumps on the boles of trees, their use for timber and especially for planks is prejudiced.

Utilisation of the finer roots of conifers, especially of the spruce, involves great injury to all trees, except for those which are to be felled very soon. The practice is confined chiefly to stray shoots of hazel, *Viburnum Lantana*, etc., which are removed by trespassers. Roots and shoots are heated (baked), twisted on their axes, and used as tough, coarse withes.

[In India and other hot countries, where scarcely any fodder-crops are raised, and where the crowding is lost in forest-pasture, used for fuel, or only for manuring valuable crops of sugar-cane or tobacco, the importance of a supply of branch-litter (rab) as manure, as well as of leaf-fodder for feeding cattle in winter, is so great, that a regular system of lopping trees for the purpose is at present inevitable. The rules under which this is permissible, in order to perpetuate the supply, are given on p. 85, Vol. IV. of this manual.—Tr.]



Fig. 368.—Cup and gutters used in collecting crude turpentine.
(U. S. Dep. of Agri. Bull. XL., 1903.)

CHAPTER IV.

**PROPERTIES, HARVESTING, SELLING AND
DISPOSAL OF RESIN.**

SECTION I. ANATOMY.*

TURPENTINE is elaborated naturally either in intercellular spaces surrounded by cells, or in certain cells. A distinction therefore is made between resin-ducts and resin-cells. The latter are parenchymatous cells in which turpentine occurs in drops, so that a cell contains more turpentine as it becomes older; as soon as the plasma leaves the cell, no more turpentine is formed in it. The plasma leaves the cells, when the sapwood, which contains them, is converted into heartwood, or when the bark, in which also they occur, is cut off from living cortex by the formation of layers of cork, or of rhitidome. All the transverse parenchyma in the medullary rays, both in the wood and cortex of conifers, contain resin-cells; in the longitudinal parenchyma, only the resin-cells that surround the resin-ducts contain turpentine; so do frequently the last cells of the annual zones of wood in silver-firs and tsugas. In the cortex, besides the cells of the medullary rays, the phelloderm, hypoderm and the gube-cells of stomata, contain turpentine.

Resin-ducts are formed only at the time of the formation of the plant-part, which contains them; there is not, in conifers, any subsequent formation of intercellular spaces by the dissolution of tissues. The partition of the walls of a cell in order to form a duct and the flow of turpentine into the duct are simultaneous. The diameter of a duct increases by the division of the cells that surround it, and as each new cell is formed, more turpentine flows into the duct. In the wood, there is no increase in the breadth of a duct after the year of

* H. Mayr, "Die Secretionsorgane der Fichte und Lärche." Bot. Zentralbl. 1885. Also, "Das Harz der Nadelhölzer." Berlin, 1894.

its formation ; in the bark, the growth in the diameter of the tree increases by tension the diameter of the resin-cells till rhitidome is formed.

The course of the horizontal and vertical resin-ducts in the wood is described on p. 37 ; Mayr has proved that each horizontal duct arises from a vertical duct, so that there is always a connection between these two systems of ducts. (Fig. 369). There is also a connection between horizontal and

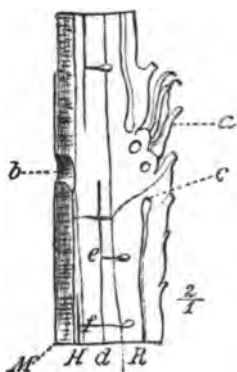

Fig. 369.—Border of two annual zones in spruce. *a* Commencement of last year's resin-duct. *b* Interruption of the pith. *c* End of present year's resin-duct ; the horizontal ducts (*e* and *f*) spring from the vertical duct *d*.

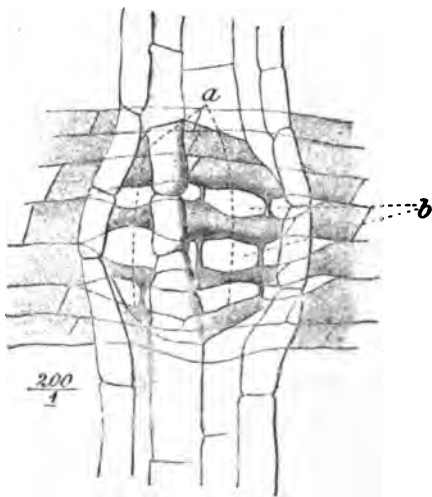

Fig. 370.—The intercellular spaces of the vertical duct *a* and of the horizontal duct *b*, showing the connection between them.

vertical ducts, wherever these ducts meet accidentally, as between (*f*) and (*d*). (Fig. 369), when both canals show large intercellular spaces (dotted lines in Fig. 369).

In pines, after the year of their formation, the cells of the ducts remain thin-walled ; in spruces, larches and Douglas-firs, more and more of these thin-walled cells are converted gradually into thick-walled, normal parenchymatous cells. Shortly before the transition of sapwood into heartwood, all the thin-walled cells that contain plasma form tyloses, which block the ducts (Fig. 370).

This closure of resin-ducts, when the wood becomes converted into heartwood, is of special importance for fixing the quantity of resin that is removed from a tree by resin-tapping, and for adjudging the effects of this practice on the quality of the wood.

Vertical resin-ducts do not exhibit, as has been maintained frequently, an uninterrupted course through the stem; according to Mayr, the longest resin-duct in spruce does not exceed 0.7 m. in length at the base of the tree, nor 0.4 m. in its upper portion. For larch, the corresponding figures are 0.3 m. and 0.15 m. The shortest ducts are near the branches; the central course of a duct is deeper than its two ends, in the annual zone, the ends being formed later than the central part of the duct. Many ducts end with the annual zone close to the cambium, but without continuing in the following year in the new zone of wood. Vertical ducts, that adjoin one another, place their lumina in communication by means of a group of parenchymatous cells, with adjoining thin walls. The number of vertical ducts increases slowly with age, on certain cross-sections of the wood; the south side of a tree contains more ducts than the north side.

Horizontal resin-ducts are always narrower than vertical ducts; they lie in the middle of medullary rays and continue in them into the bast, where they end abruptly. Their number is considerable; in spruce, there are 50 to 110 ducts on a square centimeter, but there are fewer ducts in the central parts of a stem than above or below it. During the season of rest, a horizontal duct is separated by the compact

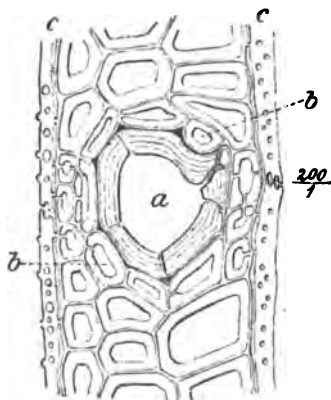

Fig. 371.—Cross-section through a vertical duct, which is surrounded by the expansion of a cell (*a*). *b* Thick-walled parenchymatous cells. *cc* Cells of medullary rays containing starch and drops of turpentine.

cambium into two parts, one in the wood and the other in the bast, so that turpentine cannot pass from one to the other ; only with the new year's growth is the connection between them restored.

All wound-parenchyma (occlusion-tissue) in wood is an abnormal holder of turpentine (p. 129) ; such a tissue contains certain wounds that are externally invisible, as are some frost wounds, while others are externally visible and cause an exudation of resin between the new and dead tissues, so that the swelling is more or less encrusted with resin. **Abnormal resin-ducts** occur also in genera which have also normal ducts (spruce, larch, pines and Douglas-firs), as well as in the other conifers. They are of pathological origin, as Tschich showed in Berne that pathological conditions, especially those due to root-fungi, also cause excessive formation of resin-blisters in the bark of silver-fir and Douglas-fir, as was proved by Mayr, in 1893.

The course of resin-ducts in the bark and needles varies in different species ; in spruces and Douglas-firs, both the ducts of the needles pass into the cortex and there unite with the vertical ducts that are 8, 13, 21, 26, etc. in number. The cortical ducts of two years shoots form two exclusive systems without any connection (Fig. 369 *a. c.*).

If a vertical cortical duct is cut, only a small quantity of resin exudes. When rhitidome is formed, on the south side of a tree, in the seventh year, on the north side in the tenth year and in a dense wood in the fifteenth year of the tree, the first cortical resin-ducts are cut off, so that spruce and Douglas-firs exhibit longitudinal ducts only up to the thirtieth year ; the bast under the rhitidome is, however, rich in horizontal ducts. In silver-firs and hemlock-spruces, the course of the vertical ducts in the cortex is the same as in the spruce ; but parts of the cortex of both these genera, as well as Douglas-fir, swell into blisters which may be tapped for resin commercially. The ducts remain active for a number of years, in silver-fir for eighty years ; the bast contains no resin-ducts. In pines, only one and two years old plants, that bear simple needles, are constructed after the pattern of the above genera, the clusters of needles (2, 3 and 5), which appear later, bear two resin-ducts in the two edges of each

needle and one in its curved side. None of these ducts are continued into the cortex, but there is a connection between the vertical ducts of the cortex of different years' shoots, that is formed early owing to the growth in thickness of the verticillary branches; cork begins to form in ten years. In larches, there is no connection between the ducts in the needles and in the cortex, only the short ducts in the brachyblasts represent the vertical cortical ducts of the other coniferous genera; the ducts in the hypoderma of the longitudinal shoots die in the first year, when cork is formed; the bast contains horizontal ducts, as in spruces, pines, and Douglas-firs.

SECTION II.—CHEMICAL AND PHYSICAL PROPERTIES OF TURPENTINE, OR RESIN.

Turpentine is a mixture of fixed and etherial carbohydrates; by its distillation, oil of turpentine is obtained, with the formula $C_{10}H_{16}$. Usually the mixture is spoken of as resin, and oil of turpentine, as turpentine.

Owing to the evaporation of etherial turpentine and its oxidation, resin usually solidifies into rosin or colophany, which is partly crystalline and partly amorphous. If fresh resin is taken from a tree and dried, the rosin forms a translucent, solid mass. The rosin increases in bulk with the age of a tree, as more and more of the etherial oil becomes oxidised. The following table shows clearly this transformation for spruce and common pine, the figures representing the percentage of rosin in the resin that exudes:—

| | |
|--------------------------------------|-----------------|
| Sapwood of spruce . . . | 74·87 per cent. |
| Resin galls „ . . . | 80·90 „ „ |
| Sapwood of pine . . . | 69·48 „ „ |
| Heartwood „ . . . | 75·59 „ „ |
| Sapwood of Weymouth pine . . . | 61·70 „ „ |
| Heartwood of larch . . . | 79·83 „ „ |
| Bark of silver-fir . . . | 62·85 „ „ |
| Sapwood of <i>Pinus rigida</i> . . . | 64·15 „ „ |

SECTION III.—DISTRIBUTION OF RESIN IN TREES.

According to Mayr's investigations, normally the root-wood is the richest part of a tree in resin, then in the order given: the base of the stem up to two meters, branchwood, the upper part of the stem in the crown of the tree, the clean bole and the bark. The part of a tree that is most valuable as timber, the bole, is therefore the poorest in resin, the southern half of the bole contains more resin than the northern half; the sapwood, in spite of general opinion due to the flow from it of liquid turpentine, is always poorer in resin than the heartwood. In the branches, contrary to the laws of gravitation, the upper side is more resinous than the lower side. The quantity of resin increases with the age of the tree, but decreases again when the tree is over 200 years old or thereabouts, so that the central zones of heartwood contain less resin than its outer zones. All conifers produce more resin in hot than in cold localities; so that border trees, trees in heavily thinned woods, on southerly aspects, in low latitudes (altitude being equal), or on sandy soil, produce more resin than under opposite conditions. The ascent and descent of resin in a tree is independent of the specific weight of its parts.

The following data regarding the amount of resin found in living trees is taken from Mayr's own observations (2.2 lbs. in a kilo.):—

| Age of tree in years. | Species. | Locality. | Contents of resin in 1 cub. m. (35 cub. ft.) |
|-----------------------|------------------|------------------|--|
| 100 | Silver-fir . . . | Bavarian plateau | Sapwood, 3.18 kilos. |
| 100 | Spruce . . . | " " | " 9.92 " |
| 45 | Common pine . . | Donautal . . . | " 13.89 " |
| 113 | " " . . . | " . . . | " 24.23 " |
| 113 | " " . . . | " . . . | Heartwood, 33.95 " |
| 235 | " " . . . | " . . . | Sapwood, 20.85 " |
| 235 | " " . . . | " . . . | Heartwood, 37.23 " |
| 80 | Larch . . . | Bavarian plateau | " 34.08 " |
| 138 | Weymouth pine | Wisconsin . . . | Sapwood, 29.47 " |
| 85 | " " . . . | Anspach . . . | " 18.82 " |

In order to compare the contents in resin of foreign trees with that of German trees, the percentage of resin in absolutely dry wood is given below:

| | Grammes. |
|---|----------|
| Norway spruce | 0·896 |
| Bavarian silver-fir | 1·213 |
| „ spruce | 1·498 |
| N. American Douglas-fir | 1·934 |
| Tyrolese larch | 2·340 |
| Norway pine | 2·426 |
| Alpine mountain-pine | 3·040 |
| Hamburg Douglas-fir | 3·892 |
| Bavarian plateau larch | 4·588 |
| Danube valley pine | 5·240 |
| Bavarian Weymouth pine | 6·704 |
| N. American „ „ | 7·876 |
| „ Pitch-pine (<i>Pinus palustris</i>) | 8·278 |

The above table shows that **Weymouth pine** is richest in resin of all German conifers, then in succession, common pine, larch, spruce and silver-fir. Douglas-fir is intermediate between spruce and larch, while pitch pine is more resinous than all the other conifers. Absolutely dry branchwood and rootwood also contain the following percentage of resin:—

| | |
|--------------------------------|-------|
| Branchwood of spruce | 5·909 |
| Rootwood „ „ | 9·857 |
| Branchwood „ larch | 4·400 |
| Rootwood „ „ | 5·835 |

Every exposed wound in a tree causes an **abnormal local amount of resin**, as the tension of the internal tissues presses the resin over the wound, and after the water in the sap has evaporated, the resin flows into the cell-walls and cell-lumina. This **resinosis** does not occur in wounds of the heartwood, for there is no flow of resin from heartwood. Fungi, such as *Armillaria mellea*, *Fomes annosus* (*Trametes radiciperda*), *Dasyscypha calycina* (*Peziza*), *Pestalozzia*, *Peridermium*, etc., also cause a flow of resin, and resinosis; at the rootstock, especially of pines, by decay, the resin is driven

gradually to the interior of the wood, which becomes charged with resin. Resinised wood, owing to its easy combustibility, is excellent for kindling purposes, and in mountain districts abroad is still employed for torches. For this purpose stems were peeled of bark in order to induce resinosis. [Brandis states (Forest Flora of N.W. and Central India, 1874) that "the wood of stumps of trees of *Pinus longifolia*, in the Himalayas, which have been notched and mutilated, is often so full of resin as to be translucent, and such wood is used for torches, and in place of candles, in houses and mines."—Tr.] Nowadays resinous wood is produced by the fungi mentioned above, or as a bye-product of resin-tapping.

SECTION IV.—RESIN-TAPPING OF STANDING TREES.

The method employed for resin-tapping depends on the species of tree and on the part of the tree from which the resin is taken. In order to avoid repetition, the reader is referred to the anatomical discussion that has preceded.

*Among European species, the maritime or cluster pine (*Pinus Pinaster*, Soland.) may be tapped most advantageously for resin; this pine yields resin most abundantly near the sea-coast between Bayonne and the mouth of Charente, chiefly among the sand-dunes and *landes* (waste, sandy tracts) of Gascony. In other parts of France, where the maritime pine grows either naturally or artificially, resin-tapping is not sufficiently remunerative to be practised.

Although other European conifers also yield resin, they do not furnish it in sufficient quantities for resin-tapping in their case to become a regular industry. In France, at any rate, their wood is too valuable to be exposed to the damage which the operation causes. However, as the silver-fir, spruce, larch, black pine and Aleppo-pine are sometimes tapped, it is useful to know how this is done. The Scots, mountain and Cembran pines are not tapped.

According to Sargent, the principal world-supply of oleo-resin comes from the long-leaved pine (*Pinus palustris*) and

* The rest of this section is taken chiefly from Boppe's "Technologie forestière."

the marsh pine (*P. serotina*) of the North American States, North and South Carolina, Georgia, Alabama, Mississippi, and Louisiana. Dr. Mohr states that 2,000,000 acres of these pines were being worked for resin in 1890, and that about 500,000 acres of new forest were taken up annually. In five or six years after these forests have been invaded, they present a picture of ruin and desolation painful to behold, the seedlings and poles being burned and all hope for the restoration of the forests excluded. At present, attempts are being made successfully to introduce a conservative system of resin-tapping into these forests * (Fig. 968).

In India, resin-tapping has been introduced by Government agency in certain forests of *Pinus longifolia* in the North-West of India, and is practised on a careful plan based on that employed in Gascony. Resin also may be obtained in India from *Pinus excelsa*; from *P. Khasya* and *P. Merkusii*, in Burma and the Malay States, also from *Pinus Thunbergii* in Japan.

A.—SUPPLY OF RESIN FROM THE MARITIME PINE IN THE LANDES OF GASCONY.

1. *Mode of Tapping.*

The maritime pine contains very large and numerous resin-ducts, and the flow of resin being much more active in the sapwood than the heartwood, superficial cuts into the former, which pass through these canals, cause the resin to flow into receptacles placed to receive it.

Towards the end of February or the beginning of March, in order to prevent pieces of the coarse external bark from mingling with the resin, the rough bark or rhytidome of the maritime pine is trimmed off as a preparatory measure, so that only a few inner cortical layers are left outside the sapwood; they then present a smooth reddish surface. Only portions of the trunk that are to be tapped during the ensuing season are thus prepared.

From the 1st to the 10th of March (according to the weather), the resin-tapper makes an incision with a special implement in the trunk of suitable trees. This is in the shape

* "A New Method of Turpentine Orchardng," by Dr. C. H. Hertz, U.S. Department of Agriculture, Bull. xl., 1903.

of a groove (*carre*) near the base of the tree and where the bark has already been trimmed, about 10 centimeters wide, 3 centimeters high, and 1 centimeter deep (4 inches by 1 inch by $\frac{3}{8}$ inch). From this groove the resin flows in viscous transparent drops, which thicken on contact with the air: part of the resin solidifies, becoming attached to the surface of the groove; the remainder, being more liquid, flows into a receptacle which has been placed on the ground to receive it. Rain-water, which may fill the pots, always remains above the resin, the specific gravity of which is slightly higher than that of water.

Once a week, and once every five days during the season when most resin flows, the groove is cut by slicing off a thin shaving of the wood at its upper extremity. The groove thus becomes gradually longer, its breadth remaining constant or being gradually reduced. As the groove becomes older, the resin ceases to flow; in freshly cutting it, the resin-tapper slices the surface of the top of the groove for a length of 10 to 12 centimeters (4 to $4\frac{1}{2}$ inches), his chief skill being shown in removing only a very fine shaving of the sapwood, so that the operation may be resumed several times without cutting deeper than 1 centimeter. This operation is effected forty to forty-five times during a season, but ceases after the 15th of October. The groove is cut in successive years up to a height of 3 or 4 meters ($9\frac{1}{2}$ to 13 feet).

Formerly, the resin which ran from a groove was collected in a hole dug in the sand at the foot of the tapped tree. This method, which now is abandoned nearly everywhere, had many disadvantages. The sand in which the hole was dug absorbed much resin; besides this, when the groove became elongated, the resin had to traverse its whole length before reaching the ground. In flowing over the groove, therefore, the resin lost much volatile matter, and became hard; needles, pieces of bark and particles of sand were blown on to it by the wind, and water or other impurities mingled with it.

In order to prevent the consequent waste of resin, Hugues, in 1860, devised a method for catching the resin immediately below the points of exudation by means of a little zinc collar which was fixed across the groove, and for collecting it in a glazed, conically-shaped pot, 14 centimeters wide at the top,

8 centimeters at the base ($5\frac{1}{2}$ and 3 inches) and 14 centimeters deep. Then, after cutting a groove, the collar is fixed below it, and the pot placed on the sand under the collar and gradually raised with the cut, as explained below. Every spring, the whole apparatus is raised above the sterile portion of the groove, where the former year's tapping had stopped (Fig. 372).

In order to fix the collar, an incision is made with a sharp, curved, steel implement, and the collar fixed in the incision. The pot is supported between the collar and a nail driven into the tree below the pot. The pots also are bored with a hole near their rim, so that they can be suspended, if necessary, and this hole allows any rain-water, which is in the pot, to drain away. Frequently, evaporation of the turpentine is prevented by covering the pot with a thin piece of pinewood. This improved system has increased the yield of resin by from 3 to $4\frac{1}{2}$ per cent., and yields a much purer resin than before, selling at 10 francs a cask more than that collected in the sand.

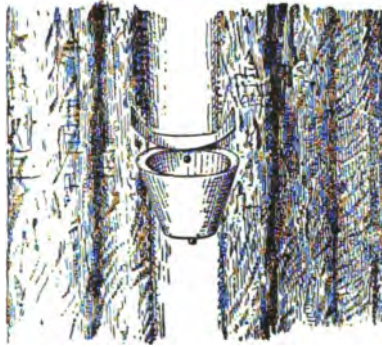

Fig. 372.*—Hugues' collar and pot.

Only the more liquid parts of the resin reach the pot, the rest solidifies on the way and remains attached to the groove. The upper part of this solid crust is removed easily by hand; it is thus collected by the resin-tapper, and is termed *galipot*. The resin in contact with the wood is much harder, and can be removed only by a scraping implement. This substance, mixed with chips of wood, is termed *barras*. When collected according to Hugues' method, hardly any *galipot* is produced, the residue being chiefly *barras*.

After the pot has become filled sufficiently with crude resin, the collector empties it into a kind of basket (*escouarte*), holding

* This, and all plates used in this section (except Fig. 384) are taken from Boppe's "Technologie forestière."

about 20 litres ($4\frac{3}{8}$ gal.) and made of rough cork, with wooden hoops, an osier handle and a round piece of wood for its base; at the same time he scrapes off the *barras*, which falls on to a cloth spread below the tree to receive it. Then the resin is conveyed to reservoirs (*barcous*), formed of half-casks let into the ground alongside the forest roads, with removable, sloping wooden covers, which keep out the rain and impurities. The *barras* is either mixed with the crude resin in the *barcous*, or packed separately in palm-leaf baskets, imported for the purpose from Algiers or Egypt. From the reservoirs the resin is ladled into casks, and carried to the factories in carts with very broad wheels, on account of the sandy nature of the roads. It is, however, proposed to improve transport of both resin and timber in the Forest of La Teste, by constructing a tramway to Arcachon, about 12 miles distant.

2. Implements used.

Various implements are used for cutting grooves, removing the crust of resin from the trees and conveying the produce to the factories.

An ordinary axe is used for trimming the bark before the grooves are cut.

A curved axe (*abschot*), with a short handle (Fig. 373), is used for cutting and freshening the surface of the groove. The blade should be sharp as that of a razor, so that the resin-ducts may be cut cleanly. Its irregular shape renders it an instrument difficult to construct and use; it can be used skilfully only after long practice, and experience in India shows that better work can be done there with an ordinary adze.

The scraper (*pelle*) (Fig. 374) is made of iron, topped with steel; it is fixed to the end of a wooden handle a yard long. It is used for scraping the lower portion of the grooves, and under the old method, for digging holes in the sand and removing the resin from them.

Another scraper (*barrasquite*) (Fig. 375) has a curved, sharp blade with a handle $1\frac{1}{2}$ metres (4 feet 10 inches) long. It is used for removing bark which cannot be reached by the axe and also for collecting the *barras* from the same places.

Another implement, termed *rasolet* (Fig. 376), has a handle 1.80 metres (5 feet 10 inches) long; it has also a step, and is used sometimes to raise the height of the grooves when above the reach of the workman's *abschot*. The workman, however,

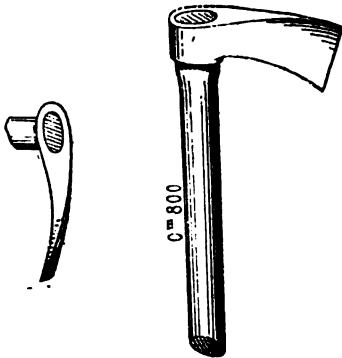

Fig. 373.—Abschot.

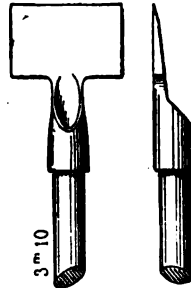

Fig. 374.—Pelle.

frequently stands on the step of the *rasolet* and uses his curved axe.

Fig. 377 shows another scraper (*pousse*), with a handle 2 meters 40 centimeters (7 feet 9 inches) long, and used, like the *barrasquite*, for the higher portions of the groove. The *palot* (Fig. 378) resembles the *pousse*, but its handle is only 90 centimeters (1 yard) long; it replaces the *pelle*, when the Hugues' method is adopted, and may be employed also as a dibble for sowing acorns or pine seeds.

The resin-tapper also uses a kind of ladder (Fig. 381) made of a small pine, into which steps are cut 30 centimeters (1 foot) apart. Each step is strengthened by a nail to prevent breakage. Considerable practice is required for a man to remain perched on this ladder whilst using the *abschote* with both hands.

The spatula (Fig. 379) is used for scraping off the resin which adheres to the pots, or to the *escourte*,

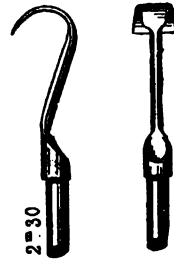

Fig. 375.—Barrasquite.

The workmen make their own ladders and *escouarte*, and buy the other implements at the following prices :—

The axe, or *abschot*, 1 franc 50 centimes the kilogram (say

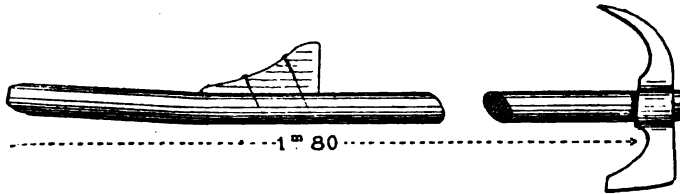

Fig. 376.—Rasplet.

6d. a pound), or 6 or 7 francs each ; the *barrasquite*, 2 francs ; the *pousse*, 2 francs 50 centimes ; the *palot*, 1 franc 50 centimes ; the *pelle*, 2 francs.

3. Method of Cutting the Grooves.

Commencing at the ground-level, the grooves ascend the stem as follows :—

| End of— | M. C. | Feet Inches |
|--|-------|-------------|
| First year | 0 55 | 1 9 |
| Second " | 1 30 | 4 2 |
| Third Year | 2 05 | 6 8 |
| Fourth " | 2 80 | 9 1 |
| Fifth " | 3 80 | 12 4 |
| Thus in the first year the length of the cut is— | 0 55 | 1 9 |
| Second year | 0 75 | 2 5 |
| Third " | 0 75 | 2 5 |
| Fourth " | 0 75 | 2 5 |
| Fifth " | 1 00 | 3 3 |

The width of the groove is 9 centimeters (3 inches) for the first four years, and 8 centimeters (2½ inches) in the last year. Its depth never must exceed 1 centimeter (¾ inch) when measured below a string stretched across the groove from the base of the bark.

The number of grooves cut at the same time in a tree vary

according as the tree is tapped without killing it, or tapped to death.

Pines that are intended to be removed in thinnings and

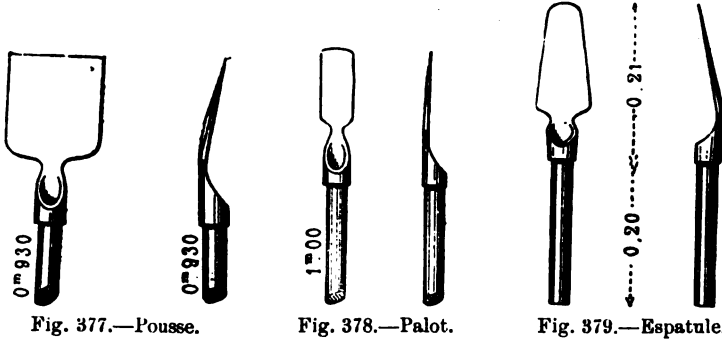

those which are considered mature are tapped to death. Such pines should remain standing for only a few years, and therefore the greatest possible amount of resin should be extracted from them. With this object, two, three, four, five and sometimes six grooves, according to its size, are cut in the same tree (Fig. 380).

Pines are tapped without being killed, when they are intended to remain for some time standing in a wood. They must be tapped so that their existence is not compromised, nor their

vigour seriously diminished. It is therefore best, in this case, to make only one groove in a tree at a time. When, after five years, this groove is 3 meters 80 centimeters (about 12½ feet) high, it is left untapped for several years, and then another groove commenced at 15 or 20 centimeters

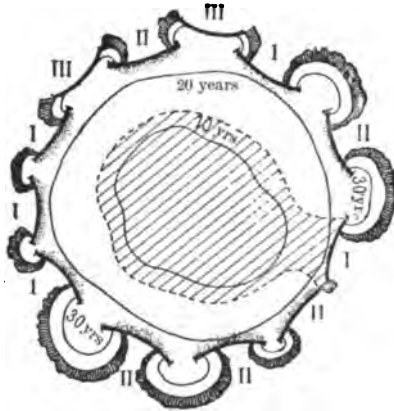

Fig. 380.
Roman figures refer to successive years' tappings.



Fig. 381.—Forest of La Teste.

An old pine is shown with a swollen base, and more than 50 grooves, it is probably at least 200 years old.

(5 to 6 inches) distant from the former, or on the other side of the tree exactly opposite to it. Thus, in time, grooves are made all round a tree, and then fresh ones are made between them. By this procedure, resin is extracted

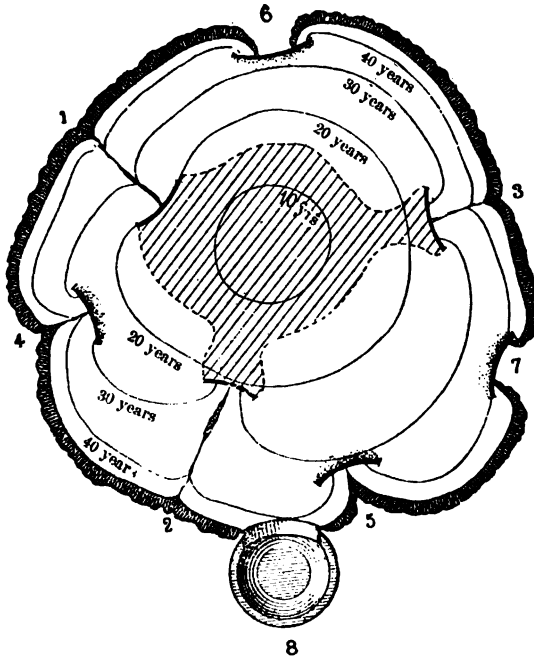

Fig. 382.—Cross-section of a pine which has been tapped "alive repeatedly."

| | |
|----------------------------------|----------------------------------|
| 1. Groove cut when 19 years old. | 5. Groove cut when 34 years old. |
| 2. " 22 " | 6. " 38 " |
| 3. " 27 " | 7. " 42 " |
| 4. " 31 " | 8. " 46 " |

The last grove still in use.

whilst the pines are kept alive for a long period (Figs. 382, 383).

When, owing to a tree being exceptionally vigorous, or to bad treatment, two grooves are made at the same time, which is generally the case in private forests, they should be worked simultaneously at different heights.

4. *Treatment of Forests where Resin-tapping is Practised.**

One of the best examples of a maritime pine forest in which resin-tapping is practised is the State Forest of La Teste, in latitude 45° , near Arcachon, bordering the Bay of Biscay. It is situated on a sandy soil, with layers of ironpan, termed *alios*. The rainfall is 32 inches and the mean temperature 56° F. With the exception, along the coast,

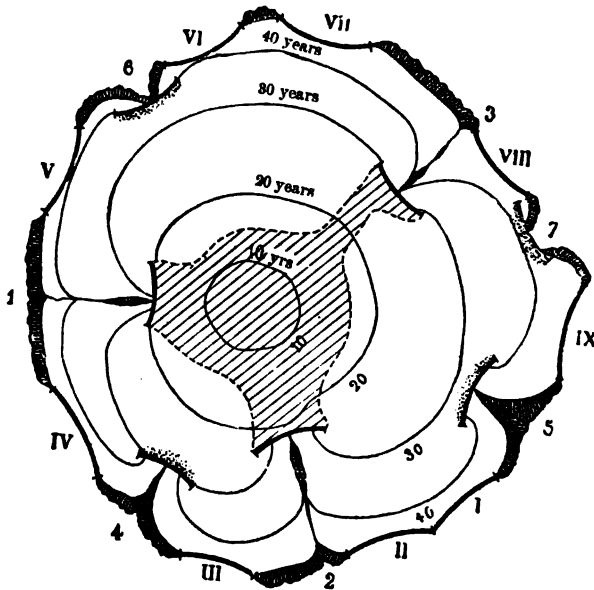

Fig. 383.—Cross-section of a pine first tapped "alive," and then tapped to death.

Grooves 1 to 7 made from age of 21 every 4 years to 45. Grooves I. to IX. made at the age of 51 years and have killed the tree.

of 1,580 acres of protection-forest which is very scrubby owing to the violence of the westerly winds and serves to protect the better portion of the forest from wind and shifting sand, the remaining area (4,500 acres) is worked chiefly for resin. It is divided into 12 compartments, averaging 375 acres each, which are regenerated successively when from 55

* This account is the result of a visit made by the translator to the forest of La Teste, in 1894, with Mr. Hearle, when Mr. Grandjean, the local forest-officer, kindly afforded full information regarding the management of the forest.

to 60 years old, there being then from 80 to 100 trees per acre which are all tapped to death in the course of five years. The trees in a compartment 55 years old are for this purpose sold standing and must be felled within the five years, being meanwhile made to yield all their available resin. The undergrowth of pine seedlings, tree-heather (*Erica arborea*), arbutus, gorse, etc., is cleared away, and the area sown naturally by seed which blows on it from adjoining areas, artificial sowing being effected, if necessary, to complete the regeneration.

Thinnings are commenced when the saplings are about five years old, maritime pine requiring more exposure to light than almost any species, especially if it is to yield resin as well as timber. These thinnings are repeated every five years, the trees being about 10 feet apart when 20 years old; the material is not saleable in the Forest of Teste till it is 30 years old, being often given away gratis for fuel, or left to rot on the area, which it does rapidly. In older thinnings, trees over 1 meter 10 centimeters ($3\frac{1}{2}$ feet) in girth which are to be removed are tapped to death in five years, whilst the other trees over this girth are tapped alive, as already described. Trees of less girth are not tapped.

A workman and his wife* can fill 60 casks of crude resin (each containing 50 gallons) from 5,000 to 6,000 grooves, representing double the number of trees; half the value of the resin collected (about 900 francs = £36) is paid him in return for his labour. One groove yields $2\frac{1}{2}$ quarts in a year.

The estimated† outturn per acre of the fellings sold in 1894 was:—

| — | Age. | No. of trees tapped. | | Timber. | Fuel. | Resin. |
|-----------------|----------|----------------------|-----------|----------|----------|----------|
| | Years. | Alive. | To death. | C. feet. | C. feet. | Gallons. |
| Final felling . | 56 to 60 | — | 94 | 1,925 | 1,090 | 430 |
| Last thinning . | 51 to 55 | 63 | 11 | 148 | 172 | 210 |

* M. Grandjean kindly has supplied the following figures: (a) A groove on the average, according to the size of the tree, yields 1 kilo. 880 gr. (1 litre weighing about 1 kilo.); (b) A man can look after about 5,000 grooves in a season and collect 40 casks of 235 litres each.

† From account by N. Hearle, "Indian Forester," July, 1895.

The timber is cut mainly into railway-sleepers and pit-props, which latter are exported chiefly to England.

The French forest officials do not consider that 60 years is a long enough rotation to get the full benefit from the forest, especially in timber, and it is proposed to lengthen it to 75 years, with 15 compartments.

Private forests of maritime pine near Arcachon are managed chiefly for the yield of resin, and consequently are tapped younger and more severely than are the State forests.

Boppe estimates that in a private maritime pine forest, 45 years old, each tree will yield $6\frac{1}{2}$ to 10 pounds of crude resin per annum. The yield per acre varies greatly, according to the nature of the soil and the management; 250 to 450 pounds per acre per annum are given as the extremes. The value of the casks of resin containing 235 kilogram (625 pounds) was 40 to 45 francs in 1885, but only 30 to 35 francs in 1894.

One of the reasons for the variation in price is that the spring-crop of resin is much lighter-coloured and freer from impurities than the autumn-crop, in which *barras* is added by the workman to the extent of 50 kilograms per cask.

The chief dangers in the forests of maritime pine are fires and invasions of shifting sand, the protective measures against which are described in Vols. II. and IV. of this manual.

B.—TAPPING OTHER SPECIES FOR RESIN.

1. *Silver-fir*.

Most of the crude resin in the silver-fir is contained in its bark, where a few drops of resin accumulate in little projecting blisters. It is collected by pressing these blisters with the sharp nozzle of a small tin vessel. This practice, which yields little and is being abandoned gradually, produces Strasburg resin.

2. *Spruce*.*

The spruce is tapped for resin by cutting long narrow grooves (3 to 6 centimeters broad and 1 to 1.5 meter long)

* [This account is taken from Gayer.—Tr.]

through the bark of the trees down to the cambium-zone. As a rule, two grooves are thus cut on opposite sides of a tree, and when the supply of resin from them falls off, two more are opened between them (Fig. 384). The crude resin pours over these grooves from the large radial resin-ducts and gradually covers them with a hard crust of resin. About a year after tapping, in the second summer, the workman removes this crust with a special iron implement, scraping it into a conical basket, made of spruce-bark, placed below the groove; he afterwards empties the basket into a larger one, in which the resin is well pressed down.



The callus, which forms over the wound, is cut about every four years to expedite the exudation of resin.

The process of resin-tapping causes decay in spruce trees, and by depriving the wood* of its resin reduces the quality of both timber and firewood. If, however, the usage be restricted to the last 10 years before the trees are felled no damage is apparently caused, except the reduction in size of the logs, due to the grooves cut in the stem.

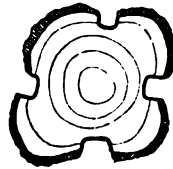

Fig. 384.—Resin-grooves in spruce.

The annual yield of resin from spruce trees in Thuringia 80 to 100 years old, when tapped during the last 10 years before they are felled, is 30 pounds of *galipot* and 43 pounds of crude resin per acre.

3. *Larch*.

Most commercial larch-resin comes from Austria, where two methods for its extraction are employed, as reported by Marchand.†

(a) **The Styrian Method.**—A hole, $2\frac{1}{2}$ centimeters (1 inch)

* The wood of the black and maritime pines, on the contrary, becomes more resinous when tapped.

† "Mission forestière en Autriche." Arbois-Jarel, 1869.

in diameter and 80 to 120 centimeters ($2\frac{1}{2}$ to 4 feet) long, is bored with an auger into the trunk of a tree as near the ground as possible, sloping upwards and passing across the axis of the tree. Crude resin exudes through this hole into a pot placed at its entrance, from which it is guided to the pot by a piece of spruce bark. Impurities are kept out by covering the pot with a leafy branch of spruce or a piece of bark (Fig. 378).

Resin-tapping exhausts the larch, so that the resin is

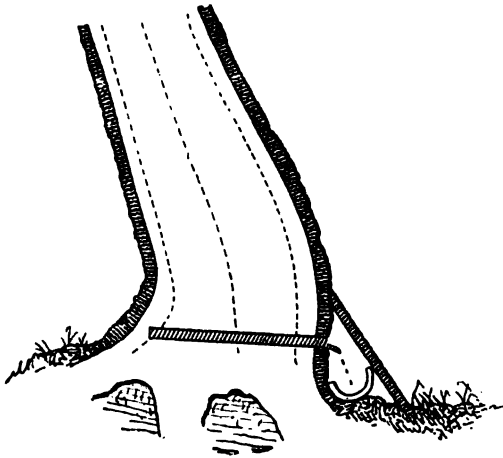

Fig. 385.—Styrian method of tapping larch.

collected for a season only at a time, the hole being then stopped with a piece of wood which is removed after a rest of from two to six years, when the flow of resin recommences. By means of this precaution the tree may be tapped for 30 years, or more.

(b) **Tyrolese Method.**—In this case (Fig. 386) the hole in the larch tree is somewhat larger than the preceding one (3 centimeters) and is either bored horizontally or at an angle towards the axis of the tree, being then closed by a plug. The resin which accumulates in this hole is removed in autumn by means of a specially made spoon.

The process is carried on only at intervals, as in the preceding case; but, though it yields more resin at first, it

weakens the tree more than the Styrian method and cannot be applied for more than 15 to 20 years.

Tapping the larch for resin yields very little profit to the owner of the trees—viz., about $\frac{1}{2}d.$ per tree annually. This is as nothing when compared with the damage caused to the wood; only trees 150 to 200 years old can be tapped.

4. Black Pine.

The black pine (*Pinus Laricio, austriaca*) is tapped in the Wienerwald by removing the bark from the base of the tree

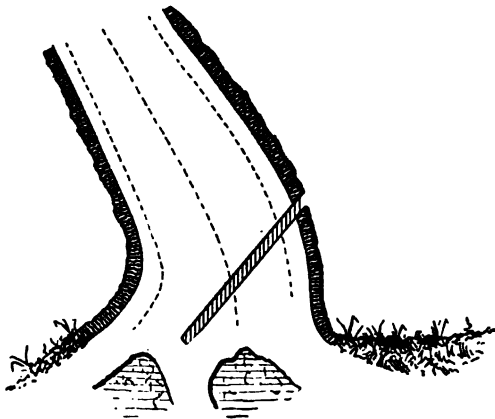

Fig. 386.—Tyrolese method of tapping larch.

over about one-third (Gayer says two-thirds) of its circumference to a height of 40 centimeters (15 inches). A V-shaped niche, which serves as a reservoir for the resin, is then cut into the base of the tree, below this blaze. The blaze is trimmed several times in a season by cutting into the sapwood, and in succeeding years it is heightened annually by 40 centimeters, small pieces of wood being inserted in cuts made in the blaze, so that the resin may not form too thick a crust, but may fall into the niche. The crude resin is removed from the niche once a fortnight, and the crust and dry resin in autumn. Thus, at the end of 10 years, the blaze will be 4 meters (13 feet) high.

These broad blazes are never occluded by new wood; the

stem, however, becomes saturated with resin and does not decay. There is a considerable loss of timber, owing to the grooving.

The black pine yields from $2\frac{1}{2}$ to $4\frac{1}{2}$ kilos ($5\frac{1}{2}$ to 10 pounds) of crude resin per tree annually; 50 pounds of the crude resin yield 7 to 10 pounds of oil of turpentine, and about 30 pounds of colophany.

SECTION V.—YIELD OF RESIN AND EFFECTS ON THE TREES OF RESIN-TAPPING.

Practical experience in resin-tapping gives the following annual yield of crude resin per tree, for the various species, the reduction in resin is approximately proportional to the coolness of the climate:—

| | | | | |
|-----------------------|---|---|---|---------|
| <i>Pinus Rhasiana</i> | . | . | . | 15 lbs. |
| „ <i>Merkusii</i> | . | . | . | 13 „ |
| „ <i>palustris</i> | . | . | . | 9.25 „ |
| „ <i>Pinaster</i> | . | . | . | 6.6 „ |
| „ <i>longifolia</i> | . | . | . | 5.5 „ |
| „ <i>austriaca</i> | . | . | . | 4.6 „ |
| „ Do (old trees) | . | . | . | 8.36 „ |
| „ <i>excelsa</i> | . | . | . | 2.64 „ |
| <i>Picea excelsa</i> | . | . | . | 1.1 „ |

The usage is leased on a definite area, or at so much a tree annually. In the latter case the height of the groove is limited. The resin may be harvested also by the forest manager and the resin sold.

The effect on the trees of resin-tapping, according to Mayr, does not involve a deterioration of the heartwood, either in specific weight, strength or durability. This has been proved by experiments made by Gomberg* in the strength of tapped and untapped trees. The sapwood is said to become less durable, its durability is little enough in any case. Nevertheless the consequent deterioration in the utility of the timber is considerable. That resinous wood is formed around the grooves is not unimportant. Stöger and Seyffert† have proved that cones and seeds of tapped pines are small and that the seedlings are weak, though no degeneration of the trees-

* United States Department of Agriculture. "Forestry Bull." 8, 1893.

† "Zentralblatt f. das ges. Forstwesen." 1878, 1885.

owing to tapping has been proved. Nordlinger showed* that during the tapping, narrow-zoned and heavy wood is produced, but that this wood is weak owing to the waviness of the fibres.

The most valuable part of the resin is the oil of turpentine, which is obtained from crude resin by distillation and is collected in a cooling tank filled with water. The process is explained in the next section.

The percentage of oil of turpentine in the resin of different trees is given below :—

| | | |
|-----------------------------|-------------------|--------------------|
| Spruce, | German turpentine | . 20 per cent. |
| [<i>Pinus longifolia</i> , | Indian | „ „ . 92 „ „ —Tr.] |
| Maritime pine, | French | „ „ . 25 „ „ |
| Austrian „ | Austrian | „ „ . 25 „ „ |
| Longleaved „ | American | „ „ . 17 „ „ |
| Larch, | Venetian | „ „ . 25 „ „ |
| Silver-fir, | Strassburg | „ „ . 93 „ „ |
| Tsuga, | Canadian | „ „ . 18 „ „ |

The distillation of turpentine from the wood of felled trees yields only impure turpentine mixed with resin and tar. Tar is made from resinous wood by dry distillation in pits or in closed retorts in remote forests. [This is described at length by Mathey (“Exploitation commerciale des bois.”) Ordinary charcoal-kilns are erected in the Landes, and the tar runs out below and is collected by a channel leading into a reservoir from which it can be ladled out after 60 hours burning of the kiln ; it is then removed every 6 hours, the resulting charcoal is light.—Tr.]

SECTION VI.—EXTRACTION OF OIL OF TURPENTINE AND ROSIN FROM CRUDE RESIN. †

Casks of crude resin continue to reach the factories at La Teste from March to October, the last consignments being

* Nördlinger, “Einfluss der Harzung auf Wachstum u. Holz der Schwartz föhre.” 1881.

† [This account is taken mainly from papers by N. Hearle and E. McA. Moir in the “Indian Forester,” June and July, 1895. Both these gentlemen, as well as the translator, in 1894, visited a resin-factory at La Teste, near Arcachon—belonging to Mr. Lesca, and all the information given in this chapter has been supplied through his kindness. Mathey, *op. cit.*, gives a more detailed and well illustrated account of the process.—Tr.]

dark-coloured and inferior in quality. From it, oil of turpentine, the chemical formula for which is $C_{10}H_{16}$, is distilled, leaving deposited an oxidised substance which is solid at ordinary temperatures, and is termed *rosin*, or *colophany*.

These substances are separated from one another in the following way :

i. By melting and filtering the crude resin, so that the water, sand, pieces of bark and other impurities* are separated from it.

ii. By distilling the crude resin, the oil of turpentine and colophany are separated from one another, as these substances have different boiling-points.

The crude resin, after being passed through straw filters, if

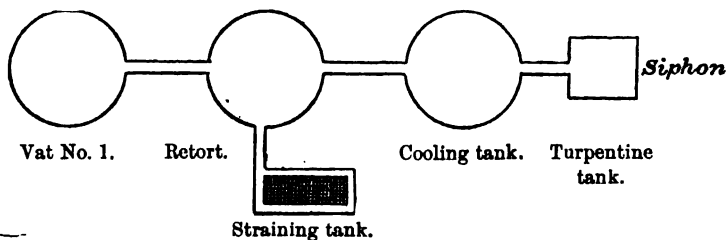

Fig. 387.—(After Hearle.)

sufficiently fluid for this to be done, is placed in an uncovered vat (Fig. 387, No. 1) and heated until it is completely liquefied. This allows heavy substances, such as sand, etc., to fall to the bottom of the vat, while light impurities, chips of wood, bark, etc., float on the surface of the melted resin. This is a very delicate operation, as if heated unequally, the resin is liable to catch fire.

The impurities are separated from the resin, either by ladling it through straw-sieves, or passing it through a grating into a second vat. The operation of heating and filtering goes on a day in advance of the distillation, so that three vats are required, No. 1 vat being always used for boiling and the other two vats, alternately, as reservoirs from which the resin is ladled into a small tank from which it is passed through a tap to the retort shown in Fig. 387.

This is the method employed late in the autumn, when the

* Chiefly larvæ of insects. This accounts for the flies in amber, fossil resin.

resin contains many impurities. Earlier in the year, it is passed directly from vat No. 1 to No. 2, a retort in which it is distilled, the arrangement of the vats then being as shown in Fig. 387.

The resin in the retort is heated to a temperature of about 185° F., steam (by the use of which 30 per cent. more turpentine is obtained) being admitted through a pipe. From this retort, vapour of the oil of turpentine and water-vapour pass through a coil of tubing into a cooling tank, where they are condensed; then they are drawn off into a smaller tank, the water remaining below with the turpentine floating on it, owing to the lower specific gravity of the latter. The oil of turpentine is run through an overflow pipe into a zinc vessel mounted on a truck, and conveyed by means of a tramway to the turpentine shed, where it is pumped into large metal tanks, measuring 10 feet by 6 feet by 6 feet, from which it is drawn, as required for sale, into old Spanish wine-casks. No system of purifying is in practice, and it is sold just as it issues from the still.

The water, which is removed by a syphon from below the turpentine, passes after use through a series of shallow open tanks in a court-yard, from which it is pumped by a small steam engine into an elevated reservoir; it is then used again for cooling the turpentine. The engine also drives steam into the distilling retort.

The liquid colophany, after distillation of the turpentine, is allowed to flow from the base of the retort by removing a wooden plug stamped with clay. It runs into a straining tank, passing over a very fine copper wire sieve, which catches most of the impurities it has still retained; the rest falls to the base of the straining tank, in the form of a black deposit resembling pitch. The straining tank has a tap placed about half-way down, through which the liquid colophany passes during autumn into another vat, from which it is ladled into large casks containing about 800 lbs.

During summer, however, after a sample has been taken out in a tin mould, the rest of the colophany is at once ladled from the straining tank into buckets, then it is carried to an open court-yard, where it is poured into open shallow metal pans about two inches deep and slightly smaller in diameter than the casks in which it is packed finally for sale. It there

cools into cakes which are exposed to the sun till sufficiently bleached; they are then placed, one above the other, in the casks and eventually unite into a single mass.

Great attention is paid to uniformity of colour in each cask, the sample shown to the purchaser being the worst coloured in the cask. The colophany goes into four main classes, for spring, summer, autumn and winter, the first being lightest coloured and most transparent; and the last, made chiefly of *barras*, being darkest. The tints vary from very pale transparent yellow to dark amber. When nearly black it is termed *brais*. Great stress is laid on transparency, denoting purity of the samples, as well as on their light colour. The dark amber-coloured colophany is worth only one-third the value of the palest brand, the prices varying from 4s. to 12s. 9d. per 100 lbs.

Besides the main classes of colophany, the commercial grades range from A. the darkest, to N. extra pale, superior to which are W. window-glass and W. W. water-white. These are American brands, which have been adopted in France.

A barrel of 520 lbs. of crude turpentine yields 364 lbs. colophany, 110 lbs. oil of turpentine and 46 lbs. refuse. The oil of turpentine sells at about 25s. per 100 lbs. Most of the manufactured produce goes to Bordeaux, whence it is shipped to the principal European countries, or used in France. The chief British supply of rosin at present comes from the United States of America, being 1,320,852 cwt. in 1906, while 235,864 cwt. came from France, 72,748 cwt. from Spain, and 21,263 cwt. from other countries, the whole being valued at £819,349.

The quantity of oil of turpentine imported into the United Kingdom in 1906, was 512,886 cwt. valued at £1,076,870, chiefly from the United States of America (396,332 cwt.) and Russia (78,334 cwt.)

SECTION VII.—COMMERCIAL PRODUCTS FROM THE CRUDE RESIN OF THE MARITIME PINE.*

The different products of crude resin are :—

| | |
|--------------------|-------------------|
| <i>Galipot.</i> | <i>Brais.</i> |
| Oil of turpentine, | Turpentine paste, |
| Colophany. | Pitch. |

* From Boppe, *op. cit.*

Galipot is dried resin picked from the tapped trees, and is used in certain varnishes, also in naval construction, especially in Holland, for painting ships and masts.

Oil of turpentine is distilled from crude resin ; it is used chiefly in oil-colours, varnishes, and medicine.

Colophany is the best part of the residue after distillation of crude resin, and is used for soap, papier-mâché, sealing-wax, etc.

Brais is obtained by heating in a retort the straw sieves used in filtering the resin, and also pine-roots. It is used in making torches, and is run into small square boxes round four or five wicks, and these are lighted on frosty nights, burning with a dense smoke, which protects vineyards from frost ; it is used also for soldering metals, or may be made into pitch.

Turpentine paste is used for varnish, sealing-wax, lithographic ink, etc. There are three kinds :—The ordinary quality is obtained after crude resin has been filtered but not distilled. *Pâte au soleil* is obtained when crude resin is exposed to the sun's heat in vessels filled with holes, through which the more fusible portions exude, forming the paste in question. When casks full of crude resin are exposed to the sun, the portion exuding through the staves is termed *Pâte de Venise*. The comparative values of these three kinds are as 37 : 40 : 250, these numbers in francs representing the value in each case of 100 kilograms.

By burning the roots and stumps, and the residue from the factory, in closed masonry chambers separated by metallic walls, **lamp-black** is obtained. Finally, by distilling pine-wood, pine oil is obtained, which may be used for lighting purposes, or as an antiseptic for preserving wood that is used in the open.

[Fig. 368 (p. 698) gives the latest American method of tapping *Pinus palustris*, which, and *P. heterophylla*, the Cuban pine, is borrowed from Mayr's suggestions, given in "Harz der Nadelhölzer," Berlin, 1894, but does not appear to be so good as the French method already described, p. 707.—Tr.]

CHAPTER V.

OTHER MINOR PRODUCE FROM TREES.

Camphor is a carbohydrate of tough, crystalline nature, with a characteristic scent and taste; it evaporates at ordinary temperatures. [There are two kinds of camphor, Japanese and Borneo camphor, their respective compositions being $C_{10}H_{16}O$ and $C_{10}H_{18}O$; the latter has an aliaceous odour and thus may be recognised.—Tr.]

Camphor is formed in sac-like prolongations of parenchymatous cells in the sapwood and other parts of the lauraceous camphor tree, *Cinnamomum Camphora*; the camphor also accumulates in the cells of the heartwood and root-wood of very old trees contain the most of this substance. Pure white camphor is obtained by cutting the wood into small pieces and dry distillation. Japan has the chief forests of camphor trees, and by the conquest of the Island of Formosa has practically a monopoly of this product; its yearly export is about 2,500 tons of camphor. The dipterocarpous tree, *Dryobalanops Camphora*, growing in Sumatra, Borneo and the Malay Peninsula, yields Borneo camphor, nine trees producing about a cwt. It is exported to Japan and China, and there used locally in preference to Japanese camphor, which alone comes to Europe.

Coniferin is a glucocid, which, by absorption of water, passes over into glucose. It occurs chiefly in the sap of the cambium of conifers, at the end of each year's growth. By oxidation, on being treated with dilute acids, coniferal-alcohol is formed, and by further oxidation, Vanillin; the latter is in white, aromatic crystals, exactly resembling those derived from the pods of the Vanilla plant.

Sugar, as cane-sugar, occurs in the sap of all woody species, especially during the season when the cambium is fully active. Economically valuable sugar can be obtained only by wounding certain species, such as maples and birches. It is not known by

what means the sugar is produced ; probably it is connected with the conversion of starch into sugar, in connection with the turgescence of the sapwood. According to Dr. J. Gifford ("Practical Forestry," 1902), America produces annually, from maples, 25,000 tons of sugar and 250,000 gallons of syrup. By tapping the tree in January, the air-temperature is over 0° C., the sugary sap exudes freely. The sugar-maple (*Acer saccharum*) is bored with an auger at 2 to 3 feet from its base to a depth of 2 to 4 inches and a piece of elder-wood without its pith, or a metallic tube inserted in the boring, a vessel being hung from the tube in order to collect the sap; the maximum annual yield of sap by each tree is about 40 gallons, from which 10 lbs. of sugar is made, or on the average 4 lbs. of sugar per tree. The sap is removed every morning, and its flow stops when the leaves come out. Trees should not be tapped till they are thirty years old, but afterwards may be tapped as long as the tree is alive. Hitherto no injurious effects in the quality of the wood or the vitality of the tree, except for the wounds caused, have been found to result from tapping the sugar-maple. European maples yield sap, which is hardly inferior in flavour to that of maple-syrup; the sycamore is specially suitable. [*Phoenix sylvestris*, the wild date-palm, is tapped in India for syrup, which is boiled down and refined into sugar, or fermented into an alcoholic drink.—Tr.]

The birch also yields sugary sap when tapped before its leaves sprout. This sap is used partly as medicine, partly after a slight fermentation, as a beverage (birch-wine).

Trees, chiefly tropical, yield dyes, which are extracted from their wood-cells; such as **Redwood** from Pernambuco (*Cesalpinia braziliensis*, *C. echinata*, *C. Sappan*); **Logwood** (*Haematoxylon campechianum*), from the W. Indies; **Red Sanders** (*Pterocarpus santalinus*), from the Cuddapah district of Madras. The bark of the N. American dye oak, *Quercus velutina* (*tinctoria*), yields a yellow dye, so does **Fustic** from the wood of *Maclura tinctoria*, from tropical America and the W. Indies, also the bark of the root of the Osage orange-tree, *Toxylon pomiferum* (*Maclura aurantiaca*) from N. America; the inner bark and roots of the common barberry also afford yellow dyes, so does *Phellodendron amurense* from Eastern Asia; the woods

of European trees and of other foreign trees yield a brown extract. The husks of the fruits of *Rhamnus Frangula* and other species yield useful dyes; the former are imported from Turkey and Persia as **Yellow** or **Persian** berries. [From the bark of *Rhamnus chlorophorus* and *R. utilis*, the Chinese prepare a very beautiful green dye called Chinese green indigo, used also for dyeing silks at Lyons, and a similar dye has been extracted from *R. catharticus*.—Tr.] The green chlorophyll and the red erythrophyll of plants are used but rarely as dyes. The fact, that many vegetable dyes are more permanent than dyes prepared from coal-tar, alone enables them still to compete with the latter.

Gums are widespread in the wood of many species, being components of their cell-walls, but only when contained in bark are they of commercial value, as they then exude through wounds in the bark of trees. Gum in the bark is suspended as latex in the sap.

[The chief kinds of gum* are gum-arabic, gum-tragacanth, gum-resins, copals, oleo-resins, and elastic gums. It is of great importance that the gums collected from different species should not be mixed, and that they should be free from bark, earth and other impurities.

Gum-arabic is a clear, white or yellowish gum, very soluble in water; it is produced by *Acacia Senegal* of N. Africa and also growing in Sind, the Punjab and Rajputana. Other acacias yield inferior gums, and so does *Bauhinia retusa*, a small tree of N. India, and many others, including the cherry-tree and other species of *Prunus*, the gum being of pathological origin. These gums are used in calico-printing, in medicine, in giving lustre to silk and for many other purposes.

Gum-tragacanth is insoluble in water, but swells up; it is produced by species of *Astragalus* and *Sterculia*. **Gum-resins** are partially soluble in water, and a type of these is gamboge, the produce of *Garcinia Morella*, a tree of Eastern India and Ceylon. A thin slice of bark is cut off of the size of the palm of one's hand, the gamboge collects there and is scraped off, when sufficiently dried. **Gum-kino**, a bright red, astringent

* "Indian Forest Utilization," R. S. Troup, Supt. of Govt. Printing, Calcutta, 1907.

gum-resin, from *Pterocarpus Marsupium*, from India and Ceylon, contains 75 per cent. of tannic acid.

Dammar, or **copal**, is a gum-resin used in making varnish. The finest transparent dammar comes from *Dammara orientalis*, the Amboyna pine, growing in the Molluccas; *D. australis* (New Zealand) also yields dammar, so does *Vateria indica*, a large tree of the Indian Peninsula, its dammar being white and valuable. Common dammar comes from *Agathis loranthifolia*, a conifer growing in Borneo and the other large islands of the Indian Ocean.

Lac is a resinous incrustation on the twigs of various Indian trees produced by a minute hemipterous insect, *Tachardia Lacca*. This substance contains a crimson dye, known as **lac-dye**; also **shellac**, used in making varnishes, cements, sealing-wax, lacquer work, lithographic ink, gramophone records, etc. For a full account of the method of production of lac, the reader is referred to Troup's "Indian Forest Utilisation."

Elastic gums include the valuable products, caoutchouc, or rubber, gutta-percha and balata.

Caoutchouc* is the produce of various trees, shrubs and climbers, growing generally within 250 miles north, or south, of the equator, usually with an annual rainfall averaging 80 inches, but in the Congo not exceeding 40 inches; the following are the chief species that yield caoutchouc:

| Natural Order. | Genus and Species. | Locality. |
|-----------------|--|------------------------------------|
| EUPHORBACEAE . | <i>Hevea braziliensis</i> . . . | Valleys of the Amazon and Orinoco. |
| | <i>Manihot Glaziovii</i> . . . | Ceara. |
| ARTOCARPACEAE . | <i>Micrandra major</i> . . . | Amazon. |
| | <i>Castilleja elastica</i> . . . | C. America. |
| | <i>Ficus elastica</i> . . . | Assam, Burma, Java. |
| | " <i>Vogelii</i> . . . | Gold Coast. |
| APOCYNACEAE . | " <i>various</i> . . . | Soudan, Venezuela. |
| | <i>Hancornia speciosa</i> . . . | Pernambuco, Peru. |
| | <i>Carpodinus lanceolatus</i> . . . | Congo State. |
| | <i>Urceola elastica</i> . . . | Borneo. |
| | <i>Funtumia (Kicksia) elastica</i> . . . | W. and C. Africa. |
| ASCLEPIADEAE . | <i>Landolphia</i> (many sp.) . . . | Madagascar, Mozambique. |
| | <i>Calotropis gigantea</i> . . . | Assam. |

* "India-rubber and its Manufactures," with chapters on gutta-percha and balata. H. L. Terry. Constable & Co., London. 1907.

Caoutchouc trees show great variations in form and size. The *Hevea* and *Ficus elastica* are huge trees, while the *Landolphas* of W. Africa are lianes, and the rubbers of the Congo State are obtained from the rhizomes, or underground stems, of plants that grow only one or two feet above the sand. The best rubber is obtained from the *Hevea* in the Amazon valley, and is known as Para rubber. Its composition is as follows :

| | | |
|--------------------------------------|-------|-----------|
| Caoutchouc | 31·70 | per cent. |
| Albumen | 1·90 | „ |
| Other nitrogenous and saline matters | 10·03 | „ |
| Water | 56·37 | „ |

The best quality of Para rubber is smoked carefully with palm nuts, before export. Rubber is prepared also most carefully in the Congo State, and is consequently in great demand.

Terry says, that, leaving out the wasteful destruction of trees by felling, the following points in the preparation of rubber call for special attention :

1. Careful tapping so that other juices of the tree may not be mixed with the latex.
2. Avoidance of mixing latex from several species so as to increase bulk.
3. Removal or sterilisation of fermentible albuminous matter.

The raw rubber production of the world for 1906 has been calculated at 65,000 tons, of which 41,000 come from tropical America, 22,000 from Africa and 2,000 from Asia. It is a characteristic of the tropics, that frequently plants from all tropical districts can be planted successfully in any tropical district. As extensive plantations of *Hevea* and other rubber-plants have recently been made in Ceylon and in the Malay peninsula and in Islands, the supply of caoutchouc from Asia will become gradually more important than it is at present.

Gutta-percha is the produce of the sapotaceous trees. *Dichopsis Gutta* and *D. oblongifolium* of the Malay peninsula, and of Borneo, Sumatra, Java, Celebes and the Philippine islands. Gamble states that the method of production has

been very wasteful hitherto. The tree is felled and the bark stripped or rings cut in it at intervals of a foot. The sap oozing out is collected, put in a pot and boiled with a little water, it is then run into moulds. The trees used are 30 to 35 years old, each tree yielding 2 to 3 lbs of gutta-percha. French exports say that it can be obtained from the leaves, which, H. C. Hill (Report on Forest administration of the Federated Malay States, 1900) says yield the best gutta-percha, valued at 15s. a lb. Hill recommends the planting of the above-mentioned species, with *Fagraea fragrans* and *Azelia palembanica* to act as nurses, and advises experiments being made to ascertain the most economical method of obtaining gutta-percha with the least damage to the crop of trees.

Gutta-percha differs from caoutchouc chiefly in its plasticity under heat.* Thus, if a piece be put in water, that is heated gradually, it becomes more and more plastic, until at 190° F. it can be drawn out into forms which it retains on cooling. It is used specially in submarine cable-factories and also for making golf-balls and for other purposes.

In 1899 the imports of gutta-percha were as follows :

| | |
|--------------------------|------------|
| Great Britain | 4531 tons. |
| Rest of Europe | 2494 „ |
| United States | 197 „ |

Terry says that since the completion of the all-British Pacific cable, exports and prices have materially declined.

Balata occurs as a latex in the bark of several sapotaceous trees, of which *Mimusops balata* is the principle producer. The tree is found in many equatorial regions, but chiefly in Venezuela, the Guianas and the W. Indies. Terry states, that unfortunately it is lumped together with gutta-percha in our trade returns, but as it is used largely in the manufacture of belts for driving machinery and is much more resistant to atmospheric oxidation and in toughness than gutta-percha, its production should be an important industry; it is used very largely in beet sugar-factories for machinery belting, as it withstand the chemical solutions met with. About 1,000 tons annually are imported into Europe.—Tr.]

* Terry, *op. cit.*

Bird-lime is made from the fruits of mistleto (*Viscum album*) and from the inner bark of holly. The inner bark of *Trochodendron* (Japan) yields a stronger bird-lime. Hydrangeas, Hibiscus and *Acer crataegifolium* (Japan) supply size for paper.

Lacquer from China and Japan is made with latex of *Rhus vernicifera*.

Oils, fats and wax.—Usually oils are pressed from seeds; beech-nuts, walnuts and hazel-nuts and many other fruits yield oil. Vegetable wax covers the bark of *Myrica cerifera*, in the southern States of N. America. Wax used in Japan for making candles and oil, is obtained from the seeds of *Rhus succedanea*, which also grows in the Himalayas. [The euphorbiaceous tree, *Sapium sebiferum*, the Chinese and Japanese tallow-tree, is cultivated in India, wax-candles are made from it in China and Japan, the wax being separated by boiling the seeds. Coconut oil is prepared from copra, the dry kernel of *Cocos nucifera*, which is an important article of trade.—Tr.]

Salicin is a bitter substance prepared from the bark of willows and poplars and used in medicine as a febrifuge, instead of quinine.

Quinine is a bitter alkaloid, coming into trade as a phosphate or sulphate. It is present in the bark of species of Peruvian *Cinchonas*, which are cultivated in subtropical countries, as coppices, resembling those for oak-bark. In very wet localities during the monsoon, the bark is stripped from the tree close to the cambium, which produces fresh inner bark. In Java, by grafting shoots that are very rich in quinine, on naturally grown seedlings, a 20 percentage of quinine has been obtained. [In India,* *Cinchona Calisaya*, at moderate elevations, yields the best bark, rich in alkaloids, of which quinine forms from half to four-fifths. *C. officinalis*, at high elevations, is not quite so rich, while *C. succirubra*, thrives at lower elevations, but is comparatively poor in quinine, though rich in cinchonine and chichonidine. The trees grow in Peru, at altitudes from 2,300 to 8,000 feet above sea-level.—Tr.]

* Gamble, "Manual of Indian Timbers." 1902.

PART III.

**UTILIZATION AND DISPOSAL OF MINOR PRODUCE
FROM THE SOIL OF THE FOREST.**

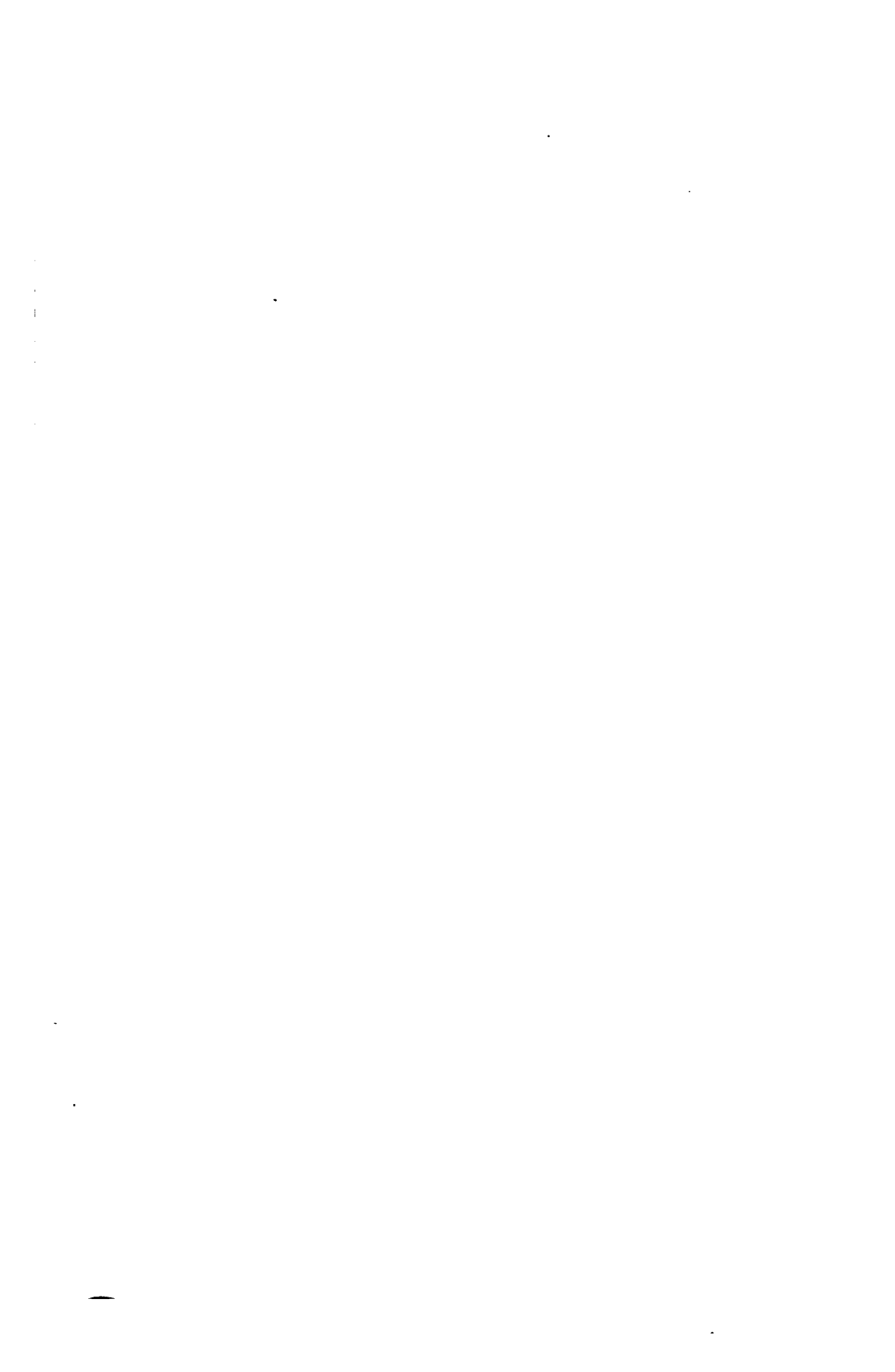

CHAPTER I.

UTILIZATION OF FOREST HERBAGE FOR FODDER.

THE natural fodder produced by forests can be used in several ways for cattle-fodder, either by driving the beasts into the forest to graze, or by allowing men to cut grass or the leaves of woody plants, and use them for stall-fodder. The present chapter is therefore divided into two sections: pasture, and grass-cutting.

SECTION I.—PASTURE.

Forest pasture includes all grasses, herbs, leaves and shoots of shrubs, as well as forest plants. The best grasses and herbage for milk production in the Alps are: *Poa alpina*, *Alchemilla alpina*, *Plantago alpinus*, *Meum mutellina*, *Achillea moschata*, etc.* The amount of fodder depends on considerations, which are discussed under the following headings.

1. *Amount of Fodder.*

a. **Climate.**—The production of fodder is greater in favourable climates; the cattle may be admitted into the forest at the end of April, or the beginning of May, and may remain till the middle of October. In unfavourable climates, the duration of pasture is much shorter, in the higher Alps, it lasts for only 10 to 12 weeks. May and June afford the best pasture, at high altitudes, also July; in these months there is more fodder than in all the rest of the season.

b. **Soil.**—As regards soil, the amount of clay it contains (up to a certain point) is the chief factor in producing fodder: sandy soils produce as a rule the least grass; limestone mountains also produce little grass, being characterised often

* W. Strecker, "Erkennen u. Bestimmen der Wiesengräser." 3rd edition, 1900.

by scarcity of springs and a slow disintegration of the rock. They also abound in deep clefts. As soon, however, as a little clay is mixed with either sand or limestone, provided that the soil does not thereby become too stiff, or impermeable by water, plenty of grass will be produced. An abundant and constant supply of water during summer is almost more important than a mixture of clay, for grass production. On this account, the crop of grass on a naturally dry soil is markedly increased by an admixture of humus, or by the shelter of a thinly stocked wood [of larch, for instance.—Tr.], which moderates radiation from the ground and protects it from drying winds: for this reason, mountain-forest grazing grounds and grassy blanks are so much moister than those outside the forest. Anyone can observe the increased deposition of dew in open land with scattered shrubs and bushes which keep-off the wind, and the comparative dryness of similar land without this protection. The depreciation of the Alpine meadows in the Tyrol, and in many parts of Switzerland and Austria-Hungary, is due chiefly to the clearance of forests. If the soil once suffers a diminution of steady moisture, sour grasses, rushes, etc. take the place of sweet meadow-grasses.

c. **Insolation.**—Grasses, clovers and most fodder-plants are usually light demanders; many of them love exposure to full sunlight, and these are most nutritive, though somewhat hard; other grasses and herbs are half-shadebearers, being less nutritive than the light demanders, but they have softer leaves and shoots. For this reason, tracts, that have been freed from trees, by clear-cuttings, storms or fire, become covered with willow-herbs (*Epilobium*), or fleabane (*Erigeron*), etc., and are less favourable than those shaded by isolated trees—such as oak-pastures in wide river-valleys, mountain larch-woods, larch plantations, meadows with pollards—forms of woodland, the chief object of which is to favour pasture.

In forests, the ground becomes covered with herbage first of all among light-demanding trees, oaks, birches, pines, etc. (Dr. Peters found that this verdure under trees comes from seeds, that have remained for a score of years and more at rest in the soil). Among shadebearers, in dense woods of spruce, silver-fir, or beech, there is no herbage; the soil-

covering consists chiefly of dead leaves. In high forest, the most favourable localities for pasture are: narrow strip-fellings, or large clear-cut areas; extensive fellings under a shelterwood, that have been rendered unfit for natural regenerations by storms, which have blown down the mother-trees, are the best places in a forest for pasture. Next to these come coppices and coppice-with-standards, with their areas either clear of trees or slightly shaded by the standards. Natural regeneration under a shelterwood diminishes the growth of herbage; in thoroughly successful cases, there is nothing for the beasts to eat except the young crop of forest trees.

2. *Species of Cattle.*

Forest pasture is used chiefly by horned cattle; also by sheep and goats; less frequently by horses or ponies. [In India, elephants, camels and buffalos may be added to the above list.—Tr.] Among these, horned cattle do the least damage, for they prefer grazing on the ground, and as long as there is sufficient grass and herbage, will not attack the woody plants. The sheep likes dry pasture, and prefers short grass among woody plants, to a strong, luxuriant growth of grass, and especially prefers fodder that has grown unshaded by trees; it attacks woody plants much more freely than do horned cattle. If there are no dry pastures, sheep peel trees in a similar way to red deer. The goat is absolutely destructive to the forest, and no other beast shows such a preference for woody plants, which it will attack, however abundant the supply of grass may be. This greedy beast, often indeed indispensable to the poor peasant, bites off the buds, young shoots and leaves, of almost every woody plant within its reach; no forest is too remote for it, and no mountain too lofty, no patch of woody growth beyond its reach, and it even bears-down fairly tall saplings with its fore-legs, in order to nibble their juicy tops. Forests in the Alps, the South Tyrol and Southern Switzerland, which were formerly so well wooded, and those of Spain, Greece, Sicily, etc., have been destroyed chiefly by herds of goats; even up to the present time a limit has not been put to their ravages.

Young cattle are always more harmful to the forest than older beasts; even calves form no exception to this rule, nibbling woody plants partly out of playfulness, partly to assist dentition. Whilst a flock of full-grown sheep may be driven without much danger through a beech or spruce reproduction-area well stocked with grass, as is sometimes done in the Harz, this can never be the case with lambs.

It is evidently necessary to base the number of cattle admitted to graze in a forest on the amount of available fodder it contains. Very many Alpine forests, for instance, have suffered greatly from an excess in the number of cattle admitted into them by grazing-rights. As a rule, the requirements of fodder per head are proportional to the weight of the beasts; thus, a cow of average size, weighing 200 kilos (4 cwt.), requires daily for its complete nourishment 7 to 8 kilos (15 to 18 lbs.) of hay; if, as Hundeshagen calculates, for every cwt. 1.8 to 2 kilos (4 to 4½ lbs.) of fodder are necessary. If calves are reckoned at two-thirds and sheep at one-tenth the weight of a full-grown cow, 5 kilos (11 lbs.) of hay are required for a calf; and ¾ kilo (1¾ lbs.) for a sheep. It is impossible to say what is the average yield of fodder in forests open to grazing, but grass, equivalent to 700 to 900 kilos of hay per hectare (5½ to 7 cwt. per acre), may be cited, as the supply in good localities.

3. *National-economic importance of Forest Pasture.*

The gain to agriculture through forest pasture, from the large quantities of grass and other herbage which forests annually produce, and from the maintenance and exercise of the beasts in the open air, is too self-evident to be controverted. On the other hand, the supply of manure is diminished considerably, and whenever, as now almost everywhere, the latter is the turning-point of agricultural profit, forest pasture is clearly a hindrance to agricultural success. The more unfavourable, however, the agricultural conditions, and the more the farmer is compelled to use all available means in order to be able to feed his cattle at least through the winter, the greater value does he attach to forest pasture. Forest

pasture, therefore, at present prevails in forest countries that are recently populated, in mountain-forest regions where the climate is severe, and also in districts where landed property is much sub-divided.

Every settler in a virgin forest district seeks to increase the growth of grass as much as possible, and opens out the dense cover of the trees for this purpose. The trees are girdled; fire, which traverses the forest annually, expedites the growth of grass by destroying the forest and leaving a prairie in its place. In America, Asia and Australia as in many localities in Europe, the opening out and destruction of the forest is the earliest mode of utilising it.

Mountainous districts permit only of poor farming; there, crops of artificial fodder are scanty and the yield in straw is insufficient for the winter's fodder-supply. Most mountainous forest districts are in this plight. The less favourable the conditions for agriculture, the more are the people driven to cattle-breeding, and the more they value forest pasture; in the Alps and higher mountain-chains of the interior of Germany, cattle-breeding and the production of milk and cheese are the chief popular industries, and forest pasture far exceeds silvicultural limits.

Excessive sub-division of landed property is also a great incentive to forest pasture. Where the poor peasant hardly possesses enough land to grow potatoes for his family, and can scarcely manage to stack sufficient fodder for the winter supply of his cattle, he will pasture them as long as possible in the forest.

4. *Effects of Pasture on Forest Management.*

(a) *Advantages of Forest Pasture.*

In only a few cases does forestry gain any advantage from pasture. These should not, however, be overlooked; they consist in the suppression of dense growth of grass and herbage in regeneration-areas and plantations, in protection against mice, and, to some extent, in keeping the surface-soil free for the germination of seeds.

There are many sheltered regeneration-areas with moist and

rich soil, on which, after only a moderate admission of light, such a strong growth of grass appears, that the woody plants under it must be stifled if the herbage is not carefully removed. It cannot be denied that in the Schwarzwald, the Harz, etc., many young plantations and woods owe their existence to cattle-pasture. Nevertheless these cases, in which grazing is useful, are very much less numerous than those in which it is prejudicial, and have caused the economic ruin of forests and their conversion in mere brushwood; this is specially true, where goats are permitted to graze in the forest.

Frequently, danger from mice follows from a dense growth of grass, especially in felling-areas near fields. Under and between the dry procumbent tufts of grass, the mice find sheltered winter-quarters, where they collect in swarms, especially under deep snow, and cause great damage to young beech and other plants by gnawing their bark. When cattle trample in the grass and herbage which is full of the runs of the mice, and the covers that protected them against enemies and the cold, have been removed, damage to forest by mice becomes much less formidable.

It has been observed in many places, that in scantily-stocked old woods with consolidated soil, where cattle have pastured, natural regeneration is obtained more easily than in others closed to grazing, provided the cattle are removed when the seed germinates. This is due to the wounding of the soil, caused by the tread of the cattle, especially on somewhat sloping ground.

(b) Disadvantages of Forest Pasture.

The realisation of the above-mentioned advantages from forest pasture is always more or less attended with danger to the forest. The damage which cattle effect in a forest is due chiefly to impoverishing the soil, browsing on the forest plants, and trampling on their roots and on the soil.

i. *Impoverishment of the Soil.*

Every usage which removes forest produce must consequently reduce the fertility of the soil; it is incontestable that

pasture removes, in the fodder consumed, large quantities of nutritive mineral matter from the forest and reduces the organic matter necessary for the formation of humus. The damage done is however slight, for the dung of the cattle remains in the forest, and many organic products are composed chiefly of air; only on shallow calcareous soil, or on gravel, can the superficial soil be said to deteriorate.

ii. *Damage by Browsing.*

Cattle graze not only on the grass and herbage of the soil covering of forests, but also browse on the leaves, buds, and young shoots of woody plants. That, by this browsing, especially if repeated annually for long intervals of time, forest growth is seriously damaged and its very existence endangered, may be proved by the present condition of hundreds of acres of forests, even if the fact is not accepted as self-evident. When and where browsing is to be feared, and the extent to which woods are thus endangered, depends on the larger or smaller supply of fodder-plants on the grazing-grounds, the species of cattle admitted to graze, the susceptibility of the woody species, the season for grazing, the age of the woods and the system of management.

Supply of Fodder.—It is obvious that when cattle do not find sufficient grass or herbage on their grazing-grounds, they will attack woody growth.

The condition of the animals as regards fodder is of immense importance to the well-being of the forest. Hungry cattle, of any kind, will attack woody growth much more readily than those that are well fed; if, therefore, there is only scanty herbage in a forest, the damage done by either horned cattle or sheep may be considerable. It is on this account that the half-starved flocks of sheep driven annually from Lombardy to the Engadine and the Tyrol are always so destructive to the forests. So, also, cattle, reared from their youth in forests attack woody growth much more than cattle accustomed to meadows and only occasionally driven into the forest. Milch cattle and breeding cattle always require the best fodder, and satisfy their hunger without wandering far;

young cattle thrive on inferior herbage, and it is even beneficial to them to be driven far into the forest for their fodder.

Species of Tree.—In general, broadleaved species suffer more from cattle than conifers; among them, it is (unless they possess acid or bitter sap) chiefly light-demanding species that are most attacked, such as ash, aspen, willow, sycamore; but also hornbeam. These species are attacked when isolated among beech, even where there is plenty of herbage. It is characteristic of cattle to prefer locally rare woody species to those of which a wood is composed chiefly. Whilst in districts where beech predominates, it rarely suffers provided there is plenty of grass, beech-plants springing up in coniferous woods with scanty herbage are attacked so freely as to grow into abnormal shapes, which can be hardly recognised as trees. Oak and alder are less liable to attack than the species already mentioned, and except the alder, the birch is the only European forest tree, which is browsed rarely by horned cattle. Sheep spare beech more than do horned cattle, but they attack light-demanding species freely, even the birch. The goat is impartial in its taste for woody species. Among conifers, silver-fir and larch are more endangered than spruce and pines, which latter suffer from browsing. The spruce escapes more easily than the softer silver-fir; the larch grows more rapidly out of danger, as the larch forests of Wallis and the Engadine show.

Season for Pasture.—Pasture is most dangerous to woody growth at two periods of the year: in the spring, when the young shoots appear and the foliage is tender and most nutritive; again, late in autumn, when the grass has become hard or scanty. The least damage is therefore done at the season when the grass is still soft and juicy, and the annual upward growth of the woody plants is about finished, *i.e.* from the end of May till the middle of July. In the higher Alpine pastures, however, the grass is not fully grown till the second half of June. If cattle are brought into the forest only when the grass has become tough and there is little after-growth, they will browse certainly on woody plants. Cattle should not be driven into the forest in the morning before the

dew has nearly dried from off the grass, or else they will attack the woody plants ; they will also do so in wet weather.

System of Management.—No damage is done by pasture in clear-fellings that are planted only after remaining blank for a few years, as a protection against the pine-weevil* : it may be advisable to continue the pasture after the planting has been effected, in order to keep down the grass, otherwise the area is closed to grazing, and in woods managed by the group system. In selection forests, not only is there far more fodder produced, but damage by cattle is more widely distributed than in concentrated even-aged forest.

iii. *Damage by Trampling.*

It is evident that young plants must be damaged when trampled by the hoofs of heavy cattle ; foals are most hurtful in this respect ; sheep also, owing to their sharp hoofs and short stride, in spite of their comparatively light weight, do much damage. Besides trampling-down young plants and shoots and bruising young superficial roots, calves jump about and crush saplings and poles. The amount of damage done, however, is modified by the configuration of the ground.

On level or gently sloping ground the damage done by the tread of cattle is only slight ; on steeper slopes, however, both horned cattle and sheep, when grazing in narrow strips of forest or passing daily in the same direction, make straight, narrow paths, on dry slopes where the grass is scanty. The effects of trampling are, however, much worse on **steep, damp slopes**, with a clay subsoil, the cattle at each step slipping and making grooves in the surface-soil, and burying every plant in their way. In forests with a deep moist coating of humus, where cattle come for the first time, it not unfrequently happens that whole crops of trees perish, because the cattle expose the superficial roots that are in the humus. Spruce crops may thus become affected wholesale with root-rot, owing to the wounds the cattle cause to their roots.

* See Vol. IV. of this Manual.

SECTION II.—GRASS-CUTTING.

Demands for grass are increasing in all forest districts.

Localities, which produce large quantities of grass, may be distinguished as **permanent**, or **temporary**, **grass areas**. To the former belong regular **forest meadows**, which owing to their naturally moist condition are adapted for a prolonged supply of good grass. **Temporary grass areas** include all those destined for the production of wood, but which, during the young stages of woody growth, are adapted for the production of grass; besides these, all **blanks** in the forest, such as the **sides of ditches**, **road-sidings**, **rides**, **fire-lines** and other similar places, may be included here, for unlike permanent meadows they are not kept clear from woody plants expressly for grass-production.

The **permanent grass-areas** are lands contained in the forest area, but used for the production of grass: these are lands liable to inundations from rivers and brooks, or near permanent springs, which afford the necessary supplies of subsoil moisture; lower parts of valleys between mountainous slopes; Alpine pastures, or similar areas, with rich moist soil in mountainous countries. Wherever there are extensive areas of this nature, and fodder is scarce, every means should be employed that the farmer uses to improve his meadows; often only a small expenditure is necessary to obtain a better crop of grass, by removing stones and rocks, draining swamps, or planting rows of trees far apart. It is not only the direct utility to the forest that should be considered by the forest manager, but public duty also should impel him to endeavour strenuously to increase the local supply of fodder, especially in essentially forest districts, where the poor peasantry are constantly increasing in numbers and becoming more and more impoverished.

For a **temporary supply of grass** the most important places are:—**felling-areas** and **plantations** with moist grass-producing soil, there, if the grass be cut carefully, this can be done not only without injury to the forest, but in the case of grass that chokes the plants, with most beneficial results. Plantations with plants that are wide apart are most

suitable; where the soil is poor and dry it is better to abstain from grass-cutting.

On all permanent forest grass-lands, the grass is mown with scythes as in ordinary meadows; where the presence of trees would interfere with the scythe the sickle is used instead. Forest revenue is obtained either by leasing the grass for longer or shorter periods, or by selling the crop in well-demarcated lots by public auction.

The grass among young growth or on felling-areas may be either plucked by hand or cut with a sickle. Hand-plucking is considered a less hurtful method, but it yields little and cannot be continued long without danger to the hands. Cutting grass is nearly everywhere effected with the common smooth-blade sickle, and but rarely with the saw-toothed one.

The season for grass-cutting cannot be begun too soon when plants are being choked by the grass. In any case, a commencement should be made not later than the blossoming period; and if, as on very rich soil, it is necessary to repeat the cutting, this should be done during autumn, for the snow will press the grass down over the young plants in winter and thus endanger them.

Grass-cutting on felling-areas is thus permissible with good supervision. The revenue for it is collected either by the issue of cheap grass-permits, giving the holder a right to cut grass on certain designated areas, or by auction-sales of demarcated lots on grassy tracts.

If the full value of the grass cut in Germany from forests could be given, its immense national-economic value would be thoroughly appreciated; it would be seen that a very considerable number of cattle obtain their summer fodder almost entirely from forests, and that often the maintenance of the poor man's cow or goat only thus is rendered possible. From the Hardtwald near Mülhausen in Alsace, for instance, the annual crop of forest-grass is estimated as at least 2,500 tons. In the forest range of Berghausen in Baden, the average revenue from grass has been 760*l.* (6*s.* an acre). In the dry year 1893, no less than 65,000 tons of grass were obtained in a regular manner from the Bavarian forests.

748 UTILIZATION OF FOREST HERBAGE FOR FODDER.

The **advantages** the forest gains from grass-cutting are similar to those already described under pasture. Plantations and natural regeneration-areas are saved from being choked by the grass, and from deprivation of light and dew; whilst damage by mice is greatly reduced, and, finally, a considerable revenue is frequently obtained.

The **disadvantages** are obvious: cutting down and up-rooting young plants, transplanting and breaking them.



Fig. 387A.—Field-crops and woods in the Ardennes. By F. Storey.

CHAPTER II.

FIELD-CROPS IN COMBINATION WITH FORESTRY.

WHEN field-crops are grown on forest land they are classed as minor forest produce. Either the field-crop or the crop of wood may preponderate in value, and the methods adopted vary in accordance with their comparative importance. These different methods will be considered *seriatim*, chiefly from a silvicultural point of view.

SECTION I.—METHODS ADOPTED.

1. *Lands permanently cleared in Forests.*

Forests contain certain lands that are always free from wood, and consequently are classed as silviculturally non-productive. These are fields given either rent-free, or at a low rent, to forest-guards, or to permanently engaged woodcutters; areas cultivated for feeding deer or other game; areas adjoining foresters' houses in the interior of forests, that are cleared to afford sufficient light, heat, and air to render them habitable, and also space for gardens, orchards, or field-crops. Strips of treeless land along roads or railways, and blanks left unstocked with trees for sporting and other purposes, may be included.

As lands thus excluded from the wood-producing forest area (except those used for feeding game) rarely are cultivated by the forest-owner, they should be leased unless they are allotted to officials or woodcutters. The foresters' orchards contain apple, pear, cherry or walnut trees, and therefore often yield some timber.

2. *Field-crops grown on Woodland without Care for Forest Growth.*

Formerly in certain localities where the value of wood was almost *nil*, it was often customary to fell and burn the trees,

and then cultivate the soil for agricultural crops as long as these would grow without manure. Subsequently the land was put under pasture. It then gradually became restocked with trees by means of coppice-shoots and seeds coming from adjoining woods. This practice is becoming rare in Europe, but has been practised extensively in America since its first colonization.

In Europe this barbarous manner of destroying forests and using the burned area for field-crops, or pasture, is followed still in Finland, Northern Sweden, in Poland and certain parts of Russia, and here and there in the Alps and Carpathian mountains. In other localities a regular utilization of the wood has been introduced, only the unsaleable parts being burned, as well as the shrubs and soil-covering. Such a system is still in force in the Swiss cantons of Luzern and Wallis. The wood on these areas is felled every 10 to 20 years, usually for making cellulose, the stumps extracted, and the refuse burned; then potatoes or corn are grown for a few years, when the land is abandoned to forest growth or used for pasture. Gradually, woody growth reappears, and after a number of years the same treatment is repeated. In the district of Birkenberge in Lower Bavaria, a similar system, now falling into disuse, was followed in woods chiefly stocked with birch and spruce trees; but in this case, a few standard trees were left to give seed, and the land constantly subjected to pasture and removal of litter, after 2 to 3 years' crops of potatoes or corn had been harvested. Some districts of the Reutberge in the Black Forest may be included, as the cultivation of trees is quite subordinated to that of field-crops. For the last 50 years, the Baden Government has endeavoured to convert this system into oak-coppice, or coniferous forest; 8 per cent. is still unconverted.

[In many hill-districts in India, a similar custom, termed *jhuming*, prevails. As an instance, the mode adopted in the Garo Hills, south of the Brahmaputra river, will be described. The Garo village-communities own land naturally stocked with trees, bamboos or grass. In October they fell all the woody growth on areas they wish to cultivate, and cut the herbage, etc., reserving a few large trees, if found on the area. Some-

times they remove a certain number of poles and other pieces of wood or bamboos for their own use, or for sale in the plains of Sylhet, and the rest of the wood is spread on the ground, and burned in March. The stumps are not extracted, but the land is hoed between them, and cotton or rice sown. In the second year, a crop of yams, chillies, tapioca, etc., is taken off the land, and then the area is abandoned to woody growth from coppice-shoots, seedlings, etc. In about ten years or less, according to the total area of land possessed by the village, the operation is repeated. The Garos levy fines on a village if a fire should spread from its lands to those of another village. The reserved trees are lopped of most of their branches, so as not to overshadow the crops, and temporary bamboo huts are built in the forked boughs of these trees, where the cultivators can sleep without fear of elephants and other wild beasts.—Tr.]

3. *Field-Crops alternating with the Cultivation of Trees.*

Wherever care is taken to protect the woody growth after the field-crop has been harvested, the latter may be considered as subordinate in importance to the former. Here, usually after a clear felling, unless the trees have been up-rooted, the stumps are extracted, the refuse burned, and the soil cultivated for a crop of corn. If the soil-covering consists of shrubs, grass, etc., it is hoed up sometimes in sods and burned in loosely piled heaps with the wood-refuse. The heaps are burned to ashes so as to leave as little charred wood as possible. The ashes and the burned earth from the sods are then strewn over the area. This system is termed in German, *Schmoren*, or *Schmoden*. If the area is hoed roughly, and all the herbage and refuse wood spread over it so that the fire passes over the whole area, the system is termed *Sengen*. This is usual when there is not much herbage on the soil, the soil-covering consisting chiefly of coniferous needles; the fire is applied against the wind, or downhill on slopes, otherwise it would be kept under control with difficulty.

In the system called *Schmoren*, the refuse is more thoroughly burned to ashes than in the latter system, which produces

more charred wood. The beneficial effects of burning the soil are, however, more marked in *Sengen*.

The field-crops last usually for two years. Generally, cereal crops are cultivated, buckwheat, rye, oats, or potatoes, a third crop being sometimes obtained. The ground cannot be cleared always early enough for spring sowing, it then lies fallow till the autumn, when it is sown for the next year's crop. As soon as the cultivation of field-crops ceases, the area is restocked with trees either by sowing or planting, and occasionally the seed of the trees is sown with the last cereal seed.

There are several varieties of this mode of treating forest land. Thus, in many pine districts, the felling-areas with reserved standard trees standing on them are leased in lots for one year's cereal cultivation, in order that the soil may be thoroughly loosened for natural regeneration of the pine. The soil must not then be too matted with weeds or roots if the cost of cultivation is to be covered by only one year's crop. In Upper Bavaria, spruce plants with balls of earth round their roots are planted in land, which has been cropped with oats. The land is cleared, cultivated, and oats sown in the spring. In the second year a crop of potatoes is reared; in the third year another crop of oats mixed with spruce seed. From the fourth to the sixth year the spruce seedlings are utilised as transplants with balls of earth, and planted in lines on the area and on other neighbouring cleared strips.

4. *Simultaneous Cultivation of Forest and Field-Crops.*

In the above-mentioned systems the felling-area is abandoned to agriculture for several years, and the cultivation of a forest-crop commences only after the last field-crop has been harvested. The wood-increment is therefore lost during the years occupied by the field-crops. There are, however, other methods in which there is no interruption in the production of wood, and the field-crop is merely intended to assist the latter. The two most important varieties of this method are termed in German, *Hackwald* and *Waldfeldbau-Betrieb*.

(a) **Hackwald.**—This is a combination of field-crops and

coppice, nearly always of oak; it has been practised for centuries in the Odenwald, in Siegen, Westphalia, Hildesheim and several other localities, and is followed most extensively in the district of Beerfelden and Hirschhorn in the Neckar-valley. As soon as the oak-coppice compartments have been felled and peeled, the bark removed, and the felling-area cleared (usually about the end of May), the felling-area, on which the oak-stools are somewhat far apart, is cultivated by hoeing and burning, as in the methods previously described. At present, in the Odenwald and in Siegen, the cultivation is only for a single crop, and the area is sown with winter-corn (in October or November).

In the Odenwald an acre of the best *Hackwald* yields about $8\frac{1}{2}$ bushels of corn. The felling-areas are leased in small lots for cultivation, either after the felling and clearance of the wood and bark, or together with the wood and bark. In Hirschhorn and Beerfelden the forest-owners first auction-off the bark to tanners at so much a cwt., and at the same time, the right of cultivation in small lots to the peasantry; the latter also buy the standing-crop, bark and wood, and the right of cultivating as well, under agreement to sell the bark at a stated price to the tanners. In Siegen an acre yields on the average 13 bushels of corn. The right of cultivation on the annually felled areas is exercised by an association of peasants. As the *Hackwald* produces usually only bark of an inferior quality, it is now so unproductive, financially, that other forms of management must be adopted.

(b) *Waldfeldbau*.—*Waldfeldbau* is a similar method to that of *Hackwald*, but is applied to high forest instead of coppice. The method adopted by *Forstmeister* Reiss of Hesse-Darmstadt has been followed in different German countries, and the following account of the experience gained in the well-known forest-range of Viernheim will suffice to explain it. The felling and clearance of the felling-area is expedited so that the land may be cultivated early in the spring. All the wood is uprooted except a few standards (oaks or Scots pines). The whole cleared felling-area is cultivated to a depth of from 1 foot, to 16 inches, and the soil, thoroughly worked, is restocked by sowing, or by planting in lines $1\frac{1}{2}$ meters (say 5 feet) apart.

Oaks or conifers are used for this purpose, according to locality. For oaks, acorns are sown 3 meters (10 feet) apart; at the same time, Scots pine nurses are planted or sown in rows to protect the oaks, and are removed eventually in thinnings. The rotation is fixed at 100 years. In the intervals (4 feet broad) between the plants, field-crops are grown on the better soils for 4 years, and on poorer soils, for 2 years.

In the first year it is usual to grow a crop of potatoes, in the second year, winter-corn; if the field-crops are continued during the third and fourth years the same order is followed. When the potatoes are dug the spaces between the forest plants are hoed, weeded, and the plants tended almost as carefully as if they were in a forest-nursery. If in the first year there should not be enough plants or seed to stock the ground, the whole area is cultivated for a potato-crop, and, as an exception, the restocking undertaken only in the autumn.

In Hesse about 10,000 acres of forest land have been thus treated. In Wurtemberg also, this system has been adopted extensively, especially on a rich soil near Bibrach. The method has been tried also in the Prussian provinces of Pomerania, Silesia, Hesse-Nassau, and in Alsace-Lorraine; in some Bohemian districts; in Hungary, where also crops of maize are reared. At present, however, the agricultural aspect of this system has lost in interest greatly for well-known reasons.

Pollards of willows, ash, poplars, etc., grown in lines on wet land, also imply a steady annual production of grass between the rows of trees.

Osier-beds are truly silvicultural means of producing material for basket-making. They are, however, but rarely managed by foresters and are regarded as a branch of agriculture; therefore a short account of them may be given here.

Osier-beds are an exceedingly remunerative form of culture. Danckelmann says that good osier-beds may yield a net annual profit of £7 to £8 per acre. To succeed, however, a moderately warm climate is necessary, a good moist, but not wet, deep soil, deep trenching and clean weeding, as in a garden. The

best osier-willows are *Salix viminalis*, *purpurea*, *amygdalina*, *rubra* (*viminalis* × *purpurea*), *alba* var. *ritellina*, *pruinosa*, etc. Planted in the ground as shoots, 8 to 10 inches long [or full-length shoots of 6 to 8 feet, as in England.—Tr.], they grow in one or two years coppice-shoots to lengths of 6 to 10 feet. Full details regarding the culture of osiers are given by Krahe, Kern,* Göschke, Piccioli, and others.

von Kern has described the use made of twelve species of willows: the wood,—for basket-work, fascines, fences, vine-props, hurdles, charcoal and fuel; the bark,—for tanning, production of salicin, dyes, tying, carpets, litter and woven shoes; the wool from their seeds for wads and stuffing; their leaves and twigs for sheep and goat fodder; their flowers for agriculture and for decorative purposes; their roots for fixing soil, protecting banks, etc.

SECTION II.—NATIONAL-ECONOMIC IMPORTANCE OF FIELD-CROPS COMBINED WITH FORESTRY.

The national-economic advantages of combining field-crops and forestry consist in the increased production of food, the fact that this can be secured without any manure, and last but not least, because the increased supply of straw really increases the amount of manure available for agriculture. These advantages, however, are diminished considerably by the difficulties of working the soil (weeds, shrubs, stools, roots, sloping ground, distance from villages); this form of cultivation is commonest in warm countries, on loose soil, in land either slightly undulating or flat, in densely populated districts, with insufficient agricultural land.

The advantages to forests from field-crops are: the consequent increase in the forest revenue, and the reduced cost of reproduction, for the ground is thus cultivated; the growth also of the forest plants is stimulated when the crop is young, and the young crop is sheltered.

The increased forest revenue by field-crops is usually only

* von Kern "Die Weiden, ihre Bedeutung, Erziehung," Benutzung. Tula, 1896 (Russian). See also Mouillefert, "Traité de Sylviculture," Felix Alcan, Paris, 1904, where there is an excellent account of osier-beds.

slight, for the expenses are considerable; only where the peasant pays for the cultivation of the ground, the demands on the forest cash-box for simultaneous or subsequent stocking with forest plants are reduced considerably. Every day experience proves that by agricultural cultivation, sowing and planting of forest plants is facilitated, and that, owing to the working of the soil, the young plants grow quickly. The protection afforded by the corn to young sowings of spruce, against lifting by frost, drought and enemies of all kinds is specially beneficial.

The principal danger caused by field-crops to the forest is the consequent reduction in fertility of the soil. The crops take from the soil those very substances, which are generally deficient (potash, nitrates and phosphates), and these materials are required just as much by woody plants as by those grown by the farmer, the latter requiring them merely in larger quantities than the former. The agricultural plants, however, grow only in the surface soil, which owing to the decomposition of the weeds forming the soil-covering and of the humus from dead leaves, etc., and to the cultivation it has received, is more or less richly supplied with assimilable nutritive salts.

The field-crop robs the surface-soil undoubtedly of a considerable amount of nutritive matter, and the more so the longer the land is under crops; the forest plants can satisfy their wants less fully in the soil, the poorer the latter, and the more exacting the species of tree grown, and the less provision has been made for its roots to penetrate deeply in the soil. But when coppice is grown associated with field-crops (*Hackwald*), the greater or less reduction in fertility of the soil occurs every 15 to 20 years only; or when high forest is so grown (*Röderwald* and *Waldfeldbau*), only every 80 to 100 years: if then, the soil-covering is carefully protected on areas so treated, no litter removed and the soil by nature sufficiently rich and moist, the results of the deprivation of nutriment will be felt very little. In the case, however, of poor soil exhausted by the field-crops, bad consequences will result for the forest growth; if this is not visible at once during its youth the wood must undoubtedly suffer in its subsequent development.

Whenever temporary field-crops are to be grown on a

sufficiently rich soil with the least possible damage to the forest crop, care must be taken that the young woody plants are rooted in a lower stratum of the soil than that in which the field-crop is grown. This is secured by cultivating the soil deeply, and restocking it with woody plants with deep rather than superficial roots, and with transplants rather than by seed.

From the above considerations it follows that, from a silvicultural point of view, field-crops may be grown profitably in combination with forestry only on well-cultivated soil rich in nutritious salts, and then it is the cheapest and most certain method of restocking a felling-area. On poor soil this system is quite unjustifiable, as has been proved in numerous cases.

Of all the methods which have been tried, the *Waldfeldbau* is the best, because it implies a thorough working of the soil, no loss of wood-increment, and clear-felled areas are at once restocked. But even on superior soils, field-crops should not be maintained for more than two years.

[Frequently in France and Belgium, cleared areas, on which conifers grew, are cultivated for one year with a field-crop, after burning (*sartage*) the soil-covering and refuse from the felling: this reduces danger of damage by insects to the succeeding crop of conifers.

In Burma, bamboos and other inferior species prevent the growth of teak, advantage is therefore taken of *jhume* cultivation, which is termed locally *taungya*, to get the area sown with teak-seed, the teak plants growing into forest after the cultivation of field-crops has been abandoned.—Tr.]

CHAPTER III.

FOREST-LITTER.

SECTION I.—GENERAL ACCOUNT.

IN forests, the mineral soil is not exposed, but it is everywhere coated with a vegetable soil-covering, which is partly dead and partly composed of living plants. The nature of the soil-covering varies according to the shade it receives. In a dense beech forest the soil-covering consists of dead leaves, husks of fruit, fallen flowers, etc., which the trees shed periodically and with which dead fallen branches and twigs are mingled. In a dense old spruce or silver-fir forest, the soil-covering consists of living and dead mosses, among which are the dead fallen needles, cones, scales of bark, etc. Under light-demanding trees, the soil is exposed to the influence of light, and, besides the fallen *débris* from the trees, it also exhibits a number of weeds of various species.

Whenever the soil-covering of a forest, consisting of dead leaves or needles and moss, is left to the natural process of decomposition, its lowest layers lose completely their organic character, only their mineral components being left. More and more organic matter thus occurs in its upper layers, till the surface consists of dead leaves or living moss. Its lower and partly decomposed layer is termed humus and its upper decomposing and living layers, ground-litter (*Bodenstreu*). While therefore in humus all vegetable structure has disappeared, in ground-litter this structure is quite recognisable.

Humus cannot be used in stalls for litter, but it has some value as manure and is appreciated by the farmer as an adjunct to litter. It is generally the undecomposed layers of the soil-covering only, that are used as litter in agriculture. Hence a distinction is made between the following kinds of ground-litter:

(a) **Dry fallen leaves or needles**, which are shed by the trees forming the standing-crop of the forest; and to some extent, by shrubs in the underwood.

(b) **Moss and grass**, partly living and partly dead.

(c) **Forest weeds**, such as broom, bilberry-plants (and other species of *Vaccinium*), heather, ferns, reeds, rushes, etc.

Branch-litter, young needle-bearing twigs of conifers, have been described already (p. 694).

SECTION II.—IMPORTANCE OF FOREST-LITTER FOR WOOD-PRODUCTION.*

It is not the business of "Forest Utilization" to deal thoroughly with the question of the importance of litter for soil-formation, climate, productivity, for forest trees individually, or for the whole forest, any more than in dealing with the utilization of wood, the effects of soil and climate and the methods of starting and tending trees, are discussed. Here only the most essential points will be explained. The works noted below may be consulted for further details.

1. *Beneficial Effects of Litter and Humus on the Growth of Trees.*

(a) **Preservation of Moisture in the Soil.**

The humus which covers the mineral subsoil and is only to a slight extent mixed with it, and the coating of litter above the humus, are the most effectual means of securing and maintaining in the soil the requisite amount of moisture. The action of humus and litter is in this respect threefold, *viz.*: The **mechanical impediment** it affords on slopes to **rapid drainage** of surface-water from atmospheric precipitations, and the time thus allowed for the water to sink into the soil-covering and the soil; the sponge-like action possessed by dead

* Ebermayer, "Die gesammte Lehre der Waldstreu," Berlin, 1876. **Wollny**, translated into French by E. Henry, "La décomposition des matières organiques et les formes d'humus," Paris, Berger Levrault, 1902. **Ramann**, "Forstliche Bodenkunde u. Standortslehre," 1893. **Müller**, "Die natürlichen Humusformen."

leaves and moss, of absorbing and retaining water, and the consequent reduced evaporation of water from the soil.

The more sloping the ground, the greater is the value of the litter in preventing torrents and floods; on slopes in the shallow soil, over rock, sand or gravel, it is absolutely necessary to maintain the litter, in order to protect the fertile soil below it from erosion.

The amount of water which is retained by the absorptive action of the soil-covering is considerable; dry coniferous needles can absorb 4 to 5 times their weight in water, dry beech leaves 7 times, and mosses 6 to 10 times this amount, without allowing it to dribble away. This absorptive power of the soil-covering is increased further by that of humus for water-vapour, which, becoming condensed in the cool soil, increases the supply of moisture.

Once the soil-covering is saturated thoroughly with water from atmospheric precipitation, it passes on the superfluous water to the subjacent soil, in the numerous interstices of which it is distributed, and thus reaches the roots of the trees. Slight showers, which are so necessary for natural regeneration under a shelter-wood, and during the dry season are fully absorbed by the litter, do not reach the plants' roots. In this respect, the litter is the more hurtful, the thicker it is. But if the rain is sufficiently heavy, the litter prevents too rapid evaporation of the water in the soil.

E. Ramann (1895) found, that the soil in dense crops of trees, with plenty of litter, is less moist than the soil of agricultural land; when the leaves come out in spring, their transformation causes a considerable loss of water from the deeper layers of the soil; shaded glades in a wood are much moister than the soil of an old crop of trees. Hoppe (1900) also showed that the soil in dense crops of trees with litter was less moist than in clearings. Ebermayer* has proved experimentally that the soil-covering of leaves and needles evaporates water $2\frac{1}{2}$ times less than does a forest soil without litter. There is a difference in this respect between leaf-litter and moss-litter. Wollny showed that the soil-covering

* "Die Physikalischen Einwirkungen des Waldes auf Luft u. Boden."

of beech leaves is the best defence against evaporation, and much more so than the rapidly evaporating covering of moss in coniferous forests, which dries up in summer. Fricke evaporated the following percentages of the precipitated water :

| | | |
|--|------------|-----------|
| Old crops where litter was removed (1). | 40 | per cent. |
| " " not " (2). | 35 | " " |
| Poles 1 and 2 | 47 and 40 | " " |
| Clear-fellings 1 and 2 | 102 and 67 | " " |

[Ototzky in Russia (1895), Tolsky in Russia (1901-2), E. Henry in France (1900-2), and R. S. Pearson in India (1904-5) have made a series of observations which show: that in all cases the level of subsoil water in forest is lower than outside the tree influence; that the level is steadier inside than outside forest; that old woods lower the level more than young woods, and that in a low rainfall area, the difference in the levels is greater than where the rainfall is more abundant. —Tr.]*

(b) Influence on Porosity of the Soil.

The activity of a soil depends also on its porosity, which affords interstices in it for the circulation of air and renewed supplies of oxygen. Litter and humus keep the soil loose and prevent its being caked by the rain. Humus becomes mixed with the mineral soil to various depths by the infiltration of water, and by the activity of earthworms, mice, moles, etc.

Wherever masses of imperfectly decomposed humus accumulate, not only water, but also the necessary mixture of organic matter, with the mineral soil, are absent; so also are earthworms and other animals and bacteria, the share of which in rendering a soil nutritive and porous is considerable.

(c) Maintenance of an Even Temperature in the Soil.

If it is correct to affirm, that, during the full activity of the roots of trees, a temperature of 68° to 72° F. is necessary, the soil-

* "Indian Forester," February, 1907, where other references are given.

covering of dead leaves, which reduces the temperature during that season must be injurious, and there would be no growth at all in the spruce, silver-fir and beech forests of the Bavarian plateau.

Mayr's observations prove, that during the months May-August, the following temperatures prevail in July:—

| Depth of soil in inches. | Bare soil. | Soil covered with dead foliage. | Covered soil and dense crop of trees. |
|--------------------------|------------|---------------------------------|---------------------------------------|
| 8 | 64° | 60° | 57° F. |
| 16 | 58° | 56° | 51° " |
| 24 | 59° | 57° | 52° " |
| 32 | 62° | 60° | 54° " |

Hence it follows:—that the soil-covering of litter, by itself, and when united to the cover of the trees, cools the soil considerably; that quite low temperatures suffice for the activity of the roots of trees, so that the cooling of the soil during the season of growth is not prejudicial: the consequent elevation of the temperature of the soil in winter, is indifferent to the plants, but involves a continuous chemical decomposition of the litter, whenever this temperature is above freezing point.

In soils containing humus, according to Frank, fungi which form a *mycorhiza* on the roots of most forest trees, are always present, they are absent in soil deprived of humus [or artificially sterilised by burning.—Tr.] and a long time passes before mycorhizae are produced. Owing to this *symbiosis* of plants and fungi, the former not only derive nutritive matter through the humus, but are enabled to obtain nitrogenous substance indirectly from the atmosphere.

(d) Fertility of the Soil.

Humus improves the productivity of soils, chiefly by its physical power of absorption, and also by its own decomposition and conversion into nutritive material. Water and water-vapour are absorbed by humus, as well as the most

important mineral and nitrogenous substances (potash, phosphoric acid, ammonia, etc.), which combine with various compounds formed in solution by humus, and are retained by it, ready for absorption by the roots of trees.

The residual products of the decomposition of humus, are ash constituents, carbon-dioxide and water; they are either quite pure, or in the form of salts that are the food and manure of the forest. By the ash-constituents, set free by the decomposition of humus, most of the nutritive matter that the production of wood has taken from the soil, is returned to it in the most assimilable condition.

From the successful use of manure in agriculture, we can see how greatly the growth of plants depends on these ash-constituents, also prove the good results obtained by manuring our nursery lines and seed-beds, and the difference between the production of wood on soils that are rich, or poor, in nutritive mineral matter.

Nowadays foresters are more and more favourable to the use of artificial manures for forest plantations, as well as for forest nurseries (Jentsch, Schwappach, Giersberg, Mathes, Baumann, Fricke and others); so also the sowing of leguminous plants, as accumulators of nitrogen, has been found beneficial to impoverished soil.

SECTION III.—MODE OF DECOMPOSITION OF FOREST LITTER.

It is well known that the decomposition of organic substances is effected only by bacteria and fungi,* the species of which are affected, relatively and absolutely, by the reaction of the soil (acid, neutral or alkaline); probably the acid products of humus are due to low organisms. If the layers of litter become dry, the process of decomposition is interrupted and unfavourable kinds of humus are formed.

The comparative rate of the decomposition of forest-litter and humus is influenced chiefly by the kind of soil-covering, soil, locality, climate, nature of standing-crop, etc.

* Ramann, Remel , Schellhorn and Krause, "Anzahl u. Bedeutung der niederen Organismen in Waid u. Moorb den. Zeitschrift f. F. u. Jagdwesen," 1889.

(a) **Kind of Soil-Covering.**—Soft and only slightly lignified parts of plants decompose most rapidly. Thus, of broadleaved trees, the dead leaves of the hornbeam, ash and lime decompose more rapidly than those of oak, beech and birch. Of conifers, larch needles are decomposed soonest, then Scots pine needles, those of silver-fir, and most slowly, those of spruce. It is generally true, that dry leaves of broadleaved trees decompose more rapidly than coniferous needles. Mosses are known to decompose very slowly : but their decomposition once commenced, they pass quickly through the condition of humus to that of complete dissolution. On this account, the living layer of moss rests on the ground with hardly any noticeable intermediate layer and may be removed from it like a carpet.

(b) **Soil.**—The most important factors in the soil, which expedite decomposition of the soil-covering, are, its capacity for heat, its degree of porosity and the amount of moisture it contains. Decomposition is generally slowest on clay or loam, quickest on calcareous soil and sand. It is especially rapid on moist calcareous soil in South Germany ; after two years most of the litter is decomposed, the humus decomposing still more quickly.

(c) **Locality.**—It is well known that decomposition proceeds more slowly on north and east than on south and west aspects ; northerly slopes are damp and cool, and in folds of the hills near the valleys the rate of decomposition is extremely slow ; in such places the greatest amount of partly decomposed humus and litter accumulates.

(d) **Climate.**—Southern countries prove conclusively that heat combined with moisture is most effective in expediting decomposition ; in South Germany, and still more in Hungary, etc., decomposition proceeds much more rapidly than in North Germany and the countries bordering on the Baltic. Whilst in the latter case 3 or 4 years are often required to complete the process of decomposition, one or at most two years suffice for the former. [In an Indian forest, except in mountainous districts, it is rare to find any noticeable layer of humus in forests.—Tr.] The contrasting climates of the lowlands and high mountain-regions of Europe have opposite effects on

decomposition; the high relative-humidity of the air and low mean temperature in mountain tracts cause deep layers of raw humus to accumulate in forests.*

(e) **Density of Standing Crop of Trees.**—Neither a dense crop of trees, nor an open, light crop, such as that of light-demanding trees, when they become old, and weeds cover the ground, afford the most favourable conditions for the decomposition of litter and its admixture with the mineral soil, as ordinary neutral mould; in both cases, the humus accumulates in an incompletely decomposed, sour condition, as peat. Peat hinders the absorption of water by the roots of the trees and prevents the aëration of the soil, it interrupts the normal loosening of the soil, and by the infiltration of solutions of humus under its superficial layers causes the formation of a hard pan. The important influence of the various **systems of management** result from the above considerations. Clear-cutting yields the densest even-aged crops; selection forests, resembling virgin forest most closely, affords the most favourable conditions. It is evident that in the tending of a wood, by thinnings, setting the older trees free, underplanting light-demanders, etc., the forester has the best means for regulating and maintaining the normal decomposition of the soil-covering of litter.

If litter and humus are to produce the most advantageous effects on forest-growth, the litter must be decomposed chiefly by bacteria and fungi, this decomposition must be moderately fast and uninterrupted.

Although it is difficult to decide absolutely the proper period for the decomposition of humus, it may be said, that for ordinary forest localities, this is most beneficial, when broad-leaved litter is converted into humus within three years, and coniferous litter in three or four years, while the layer of humus below is only a few centimeters thick.

The hurtful effects of breaking up the soil and mixing litter and humus on poor soil, by pigs, a comparison of the humus in such areas, with others in which pannage is not allowed, will demonstrate clearly.

* Ramann, "Die klimatischen Bodenzoneen Europas." *Bodenkunde*, 1901, St. Petersburg.

From the above considerations it is evident, that forest litter is one of the most important factors in the productivity of the soil. As in forestry, where practised on a large scale, it is impossible to substitute manure for litter; normally decomposed litter by its physical and chemical properties and its effects on the soil, is indispensable.

SECTION IV.—AMOUNT OF FOREST-LITTER PRODUCED.

Owing to the importance of moss and weeds as well as dead leaves and needles in the supply of litter for farmyards, the different nature of these kinds of litter and the various ways in which they affect wood-production, it is necessary to consider the question separately for each kind of forest litter.

1. *Dead Leaves and Needles.*

Experience shows that the annual amount of litter produced from dead leaves and needles in a forest varies with the species of tree, locality, weather, density of crop and age of trees.

(a) **Species of Tree.**—Three factors have great influence on the amount of litter produced by European forest trees; namely, the density of the foliage, its duration on the trees and the suitability of the species to form a more or less dense leaf-canopy. Considering all these factors, not for individual trees but for a crop of trees, and deducting the amount of moss produced in coniferous forests, the species may be arranged, as follows, in descending order of their comparative production of dead leaves or needles:—

- Beech;
- Sycamore and other maples, lime, sweet-chestnut, hazel;
- Hornbeam, alder, black pine;
- Elms, oaks, black poplar;
- Scots pine, larch;
- Spruce, silver-fir;
- Ash;
- Birch, aspen.

The density of foliage of a species depends on the nature of the locality and its mode of growth. Silver-fir, spruce and beech have the densest foliage; that of hornbeam, sycamore,

ash, elm, lime, Weymouth pine, sweet-chestnut, alder and hazel is also dense though comparatively lighter than the above; oaks, poplar, birch, pines and larch close the list.

The duration of the leaves on the trees is longest for evergreen conifers, silver-fir, spruce and pines. In the case of the black, Weymouth and Scots pines, the needles remain from two to four years; in the spruce and silver-fir, four to six years and even longer for the latter. Hence it follows that pines shed about one-third of their foliage annually, the spruce and silver-fir only the fifth or sixth part. These species, therefore, are much worse producers of litter than follows from the density of their foliage.

Silver-fir, spruce and beech possess in the highest degree the property of growing in **densely stocked woods**, next come the hornbeam and hazel—some way further down in the list—alder and sycamore. In the case of ash, elms, oaks, sweet-chestnut, birch, aspen, Scots pine and larch, the woods open out much earlier. As compared with woods of light-demanding trees, those of mixed light-demanders and shade-bearers produce more litter, whilst woods of spruce, silver-fir and beech produce litter most abundantly.

(b) **Locality.**—The nature of the locality in which it is grown has the greatest possible influence on the wellbeing of a species of tree. The more a locality suits a tree, the greater, other conditions being equal, will be the production of litter. As a rule, a **moist atmosphere**, provided there is **sufficient heat** available for the species in question and a **rich soil**, increases the density of the foliage.

R. Weber's* note on beech leaf-production should also be noted, viz., that it falls off in quantity with the altitude.

(c) **Weather.**—Any casual observer must have noticed that according to the changes of weather in different years, the forest presents different appearances, being in certain years fresher, greener and possessing denser foliage than at other times. **Spring weather**, when the foliage is produced, is most decisive in this respect. Years with **severe late frost and dry seasons** produce less foliage than moist years free from frost.

* Ebermayer, "Die Waldstreu," p. 37.

According to Krutzsch, there may be a difference of 60 per cent. in the amount of foliage produced by Scots pine and beech in wet and dry years. Severe storms during the season when leaves are produced are very prejudicial to the supply of foliage.

(d) **Density of Growth and System of Management.**—The densest woods do not produce most litter, nor do open woods where each tree is exposed completely to the influence of light, the number of individual trees being then too few. The most litter is produced annually when there are as many stems as possible in a wood, with the proviso that each stem has ample room for its growth—a density which results from well-executed thinnings.

Even-aged woods exercise a similar influence to that of the density of woods on the annual supply of litter. When all trees in a wood are of the same height and their crowns form a dense leaf-canopy at a uniform level above the ground, the influence of light is far less than when the heights of the trees vary, when lateral light is admitted between the groups of the taller trees and their crowns consequently grow lower down their stems, as in the group and selection systems.

(e) **Age of Trees.**—The greatest production of dead leaves and needles is during the pole stage, and falls off only slightly in the older stages of high forest, provided the leaf-canopy is fairly complete.

The following results give the average yield of litter as determined by observation* made in the Bavarian State forests.

One acre of dense forest of the ages given in the subjoined statement produces annually so many tons of air-dried litter:—

| Age of Wood. | Beech. | Spruce. | Scots pine. |
|-----------------|--------|---------|-------------|
| Years. | Tons. | Tons | Tons. |
| Under 30 | — | 2·50 | — |
| 25 to 50 | — | — | 1·56 |
| 30 " 60 | 1·67 | 1·58 | — |
| 50 " 75 | — | — | 1·4 |
| 60 " 90 | 1·64 | 1·35 | — |
| 75 " 100 | — | — | 1·69 |
| Over 90 | 1·62 | 1·31 | — |
| Average | 1·64 | 1·42 | 1·48 |

* Ebermayer, "Die gesammte Lehre der Waldstreu," Berlin, 1876.

It is evident that, when the litter is allowed to accumulate in a forest for several years, the supply is greater than that produced annually. At the same time the accumulation is limited, as the lower layers are constantly decomposing and only the upper layers are available for litter. In this respect investigation has led to the adoption of the following average figures per acre :—

| No. of years. | Beech. | Spruce. | Scots pine. |
|-------------------------|--------|---------|-------------|
| | Tons. | Tons. | Tons. |
| 3 years' supply ... | 3·26 | 3·04 | 3·56 |
| 6 " " ... | 3·39 | 3·76 | 5·49 |
| Over 6 years' supply... | 4·17 | 5·54 | 7·31 |
| Average ... | 3·61 | 4·11 | 5·45 |

A cubic meter (35·3 cubic feet) of air-dried litter (15 to 20 per cent. water) well compressed is of the following weight :—

| | Kilos. | Lbs. per cubic foot. |
|-----------------------|--------|----------------------|
| Beech | 81·5 | 5 |
| Spruce | 168·4 | 10·5 |
| Scots pine | 117·3 | 7·3 |
| Moss-litter | 104·0 | 6·5 |

Hence the yield of litter may be calculated in stacked cubic meters or in waggon-loads per acre (as in the following statement) as waggons drawn by two horses usually carry 5 stacked cubic meters (176·5 cubic feet) of litter :—

| | Beech. | Scots Pine. | Spruce. |
|-------------------|--------|-------------|---------|
| One year's supply | . 10 | 6 | 4 |
| Six years' ,, | . 20 | 16 | 11 |

2. Moss-Litter.

The forest is the home of most mosses, especially of the larger species, which may be used for litter. The growth of moss depends generally on the presence of damp soil and air, and a certain amount of cover. Only a few mosses can stand full exposure to light. Some kinds of forest mosses form large tufts only exceptionally, whilst other gregarious mosses



Fig. 388.

(Drawn by R. S. Troup, after Schwarz.)

1. *Polytrichum commune*. 2. *Sphagnum cymbifolium*. 3. *Hylocomium triquetrum*. 4. *Hylocomium splendens*.

under favourable circumstances may carpet the ground over extensive areas. If these carpets are formed of the larger kinds of moss, they yield a very important form of litter.

Of the mosses employed usually for litter, several species of the large genus *Hypnum* and of other genera are common, as:—*Hypnum Schreberi*, *purum*, *cuspidatum*, *molluscum*, *cupressiforme*; *Hylocomium splendens*, *squarrosum*, *triquetrum* and *loreum*; *Brachythecium rutabulum*; *Campothecium lutescens*; *Thuidium tamariscinum* and *abietinum*, etc.; also *Polytrichum formosum* and *urnigerum*; *Dicranum scoparium*; *Bartramia fontana*; *Climacium dendroides*; on wet, swampy ground, besides some of the above, species of *Sphagnum* predominate.

The quantity of moss in a forest that may be used for litter, depends chiefly on the species of tree of which the standing-crop is composed, the age of the wood, and the system of management.

As regards species of tree, moss is most prevalent in coniferous woods, and especially in those of spruce and silver-fir; it is rare for broadleaved woods to produce moss in sufficient abundance to be utilizable as litter. The older the trees, the greater the amount of moss, unless opening the cover should admit sunlight and dry the soil, when the mosses cease to thrive. The system of management followed is also influential.

It is chiefly the annual fall of dead leaves in broadleaved woods that forms an obstacle to the growth of moss, as they intercept the small amount of light which mosses require, and small tufts of moss which may be produced here and there are stifled by the dead leaves falling on them in succeeding years. It is different in coniferous woods: the thinner coating of dead needles affords room for the spread of any mosses which have germinated and sufficient light for their development. As the moss then grows regularly through the annual fall of needles, the litter consists of an inseparable mixture of moss and dead needles, and only exceptionally can they be collected separately.

* Vide Braithwaite's "British Moss Flora"; also James' "Field-Flora of Mosses."

In Scots pine and larch woods, moss is generally an unimportant factor in the soil-covering, or may be completely absent. Hunger-moss, or Iceland-moss (*Cetraria*) is a lichen and denotes great poverty of soil.

As regards age, in the early years of dense spruce and silver-fir forests, there is only a slight production of moss; after the leaf-canopy has become elevated, so as to admit sufficient light to the soil and allow for a slight movement of air-currents, moss gradually spreads over the ground. It then continually becomes denser and deeper the higher the leaf canopy, and attains its maximum in mature woods which have been already thinned and contain *advance-growth*,* provided the soil continues moist.

The system of management affects the growth of moss, in so far that uneven aged woods, resulting from natural regeneration by seed, are generally more favourable for the production of moss than even-aged and artificially formed woods.

Wherever the growth of moss is luxuriant, it regenerates itself after removal for litter more rapidly than under opposite conditions. If the moss has been completely removed, an interval of 3 to 5 years passes before it is reproduced, and this may be longer on poor soils.

3. Litter from Weeds.

The forest weeds, which are used chiefly as litter, are heather, broom, *Genista* and ferns: less frequently—bilberry-bushes (*Vaccinium Myrtillus*) and other species of *Vaccinium*, reeds, grass, etc.

Heather, chiefly ling (*Calluna vulgaris*), [but in Britain, also bell-heather (*Erica cinerea*) and cross-heather (*E. Tetralix*).—Tr.] produces a sour, partly-decomposed humus, which when the soil is dry, resembles charcoal-powder, but when the soil is wet, forms a moist mass; heather predominates on open sunny localities and on poor silicious soils, where it spreads freely and produces peaty heather-humus. The removal of the heather with the sods of humus, that are full of its roots,

* *Advance-growth*.—The seedling underwood springing-up in a high forest.

is generally beneficial for forest plants, which can overpower this weed only when they have formed a closer canopy of shade. [In Britain, however, the heather serves often as a protection to young plants against spring-frosts, and they do not suffer from its presence so much as in the drier climate of the Continent.—Tr.]

The broom (*Cytisus scoparius*) is produced by nearly every kind of soil; it is chiefly prevalent on silicious soils, but also grows on argillaceous schist, quartzite, limestone, and even on chalk. It always implies an admixture of certain clay in the soil. It resembles heather in requiring a complete exposure to light and a moderately warm atmosphere.

Among ferns, the widely-spread bracken (*Pteris aquilina*) is most important, *Aspidium Filix-mas* and *Asplenium Filix-femina* also are used as litter. They require a moist, or even wet soil, but cannot stand stagnant moisture. Half-shaded localities, or fully exposed but cool, damp places, suit them best.

They grow best in moist, no longer completely closed old woodlands, especially in spruce and silver-fir forests, with a moderate soil-covering of moss. Clearings for plantations, on northerly aspects with a rich soil, also produce a vigorous growth of ferns.

Bilberry (*Vaccinium Myrtilus*) and other species of *Vaccinium* are less frequently used as litter than the above-mentioned plants; their stems are usually too woody and no weeds decompose more slowly. They require an amount of clay in the soil, and needs shade in soils free from clay, and consequently dry.

Species of *Vaccinium* hence are found in loamy soil in lightly shaded, old woods, when the soil has become superficially impoverished; more on warm than on cold aspects, both in broadleaved and coniferous forests. A large supply of *Vaccinium* litter, therefore, always implies deteriorating old woods, or stunted young woods containing blanks. On superior soils a vigorous growth of bilberry is also found in young woods not yet fully closed. The bilberry, like many other forest weeds, has a superficial root-system, but no other weed covers the ground so thoroughly with its densely matted

roots.* Hence results the superficial impoverishment of the soil, so far as the bilberry roots extend.

In wet, swampy localities, on fairly level ground, many species of reeds and sedges grow (*Juncus*, *Carex*, etc.); they have long, broad leaves which die early in the winter, and can be raked together easily. In some districts, as in Upper Bavaria, meadows of sour grasses, rushes, etc., are used for litter.

SECTION V.—MODES OF HARVESTING LITTER.

The different ways in which litter is harvested are all extremely simple, but differ according to the kind of litter in question.

1. *Litter from Dead Leaves and Needles.*

In collecting litter composed almost exclusively of dead leaves or needles, with only a few weeds and a scanty admixture of moss, wooden rakes are always used.

Iron rakes are quite inadmissible, as they not only damage the superficial roots of trees, but also penetrate the layer of humus, which they remove partly, as well as the litter. Thin layers of moss are also removed easily by means of wooden rakes. The heaps of dead leaves and needles are packed in cloths or nets for removal either to the farms or to a forest depot, where the litter is measured for sale, or carts are laden with it on the spot.

On smooth ground it is easy to rake up every leaf, but when the surface is uneven, interrupted by holes, hummocks, stones, rocks and roots, or overgrown with shrubs, bushes, grass or weeds, or finally, in places where swine have been rooting—raking is a difficult process. A considerable amount of litter which cannot be raked up is then preserved to the forest, and thus an indication afforded how the forests may be protected by artificial means against a too complete removal of litter.

* [Species of *Strobilanthes* have a similar habit in India, and most of them blossom periodically, every 5 to 10 years. After blossoming, the whole crop dies, and thus allows tree seedlings to take root—otherwise an impossibility. Species of *Strobilanthes* are common in oak-forests in the Himalayas, but the genus is best represented in the Nilgiri Hills, where some kinds are used largely for fuel. Gamble, "Manual of Indian Timbers," p. 519.—Tr.]

2. *Litter from Moss.*

Wherever the moss has grown into cushions, in which, as in silver-fir and spruce woods, the needles are embedded, it can be raked together. Certain kinds of moss, however, can be gathered only by hand.

3. *Litter from Weeds.*

Heather is the most productive form of weed-litter, and is harvested in different ways according to its age and silvicultural requirements. Heather is cut usually with the sickle, provided it is not more than 3 to 4 years old; when old and woody, it must be cut with a strong knife, or whenever there is no fear of injuring forest plants which are growing among the heather, it may be pulled up by hand. Whenever the heather is harvested on blanks, or waste land, it is best to use a strong scythe, and when not only the heather but the grassy or mossy tufts which accompany it are utilised, a broad, sharp hoe is used. Bilberry and other *Vaccinium* undergrowth, also broom and ferns, when used for litter, are harvested like heather. All the heather and other weeds, which have been gathered, are brought usually in cloths to the forest depot; broom and ferns are often firmly tied on the spot into bundles by means of withes.

SECTION VI.—LIMITS TO USE OF LITTER.

The forester must endeavour to render the removal of litter as innocuous as possible. Thus the demand for litter should, if possible, be met by supplying those kinds which the forest can best dispense with; places and woods are opened which can best withstand the loss; the intensity and length of rotation of the removal of litter should be modified in places which are most liable to injury, and a season chosen for the usage when the soil is least exposed to be dried up.

1. *Kind of Litter.*

Litter from roads, halting-places, ditches and blanks, and from forest weeds, may be supplied with least injury to the forest.

Only when other sources of supply fail should the removal of ground-litter be permitted from the woods. The remaining paragraphs refer to that mode of litter only.

2. *Locality.*

The better localities should be taken in hand first, the inferior ones being spared as long as possible. Litter which has been heaped up by the wind in wet places, on moist, low-lying ground, in hollows, ravines or narrow valleys, and thick cushions of moss in damp ground and on places about to be regenerated naturally, may be utilized with the least damage to the forest. There is sometimes in cold localities a stiff, heavy soil, which is improved by removing the litter. The north and east slopes of hills, with rich deep soil covered with scattered blocks of stone or boulders, and terraces or gentle slopes on mountain-sides, should always be preferred, the more exposed places being used only as a last resort. Places exposed to wind, such as hill-tops, mountain-ridges, steep declivities and especially the upper parts of steep mountain-chains, should be spared always.

3. *Nature of Crop.*

Vigorous, dense, mature crops of trees should be opened for the removal of litter in preference to other parts of a forest. All woods that are deteriorating for any reason—which have suffered from caterpillars, snow-break, wind-break, drought, etc., or in which, from any cause, the leaf-canopy has opened out—for instance, immediately after thinnings, preparatory fellings, etc.)—must be protected as long as possible against the removal of litter. All woods intended for immediate natural regeneration, and even-aged old woods ready for felling may be opened, but all young woods, till they have reached middle-age, should be spared. Litter should, as far as possible, be preserved carefully in coppice-with-standards and coppice, and especially in oak-bark coppice.

4. *Intensity of the Usage.*

Only **undecomposed** litter should be removed, that in process of decomposition being preserved. This proviso cannot

indeed be completely secured, but every effort must be made in this direction and the removal of the humus should never be permitted. The more a locality requires protection, the more superficial should be the removal of the litter; this is possible if the workmen are engaged by the forest-manager, but when the peasants remove litter on their own account, it is better to allot a large area instead of a small one for the removal of litter. The mossy carpet in spruce and silver-fir forests should never be removed entirely, but only in patches or strips. The hoe must never be used for removing heather in sods. When dead leaves are raked together, only a wooden rake with wide intervals between the teeth should be used, never an iron rake.

5. *Length of Close-time.*

The length of close-time between two successive removals of litter from the same area depends on the nature of the locality; the soil and configuration of the ground should be considered first, and, only in the second place, the species, age, and condition of the wood. It requires no argument to prove that the forester should insist on as long a close-time as possible, and should only consent to an interval less than six years when absolutely compelled to do so. The close-time may be shortened in crops of trees that have attained their full maturity, but must be kept as long as possible in the case of young woods.

6. *Season.*

Heather and broom should be harvested just before they are completely in blossom, ferns* in the autumn; on regeneration-areas it is better to collect litter somewhat late in the year. Ground-litter should be raked up chiefly in autumn, while the leaves are falling. Wherever the removal of litter must take place in spring, it should be restricted as much as possible in quantity; the farmer, however, requires more litter in spring than in autumn. Dry weather is preferable for the removal of litter, as then the work is less laborious, and because, in wet

* [Hon. G. Lascelles, Deputy Surveyor, New Forest, states that if bracken is cut before the end of September, as in the forest of Dean, its rhizomes become greatly weakened, and the crop becomes gradually poorer.—Tr.]

weather, in order to obtain dry litter, the peasant will select the very places that are most liable to damage.

7. *Plan of Operations.*

It is in many places usual to draw up a plan of operations for the removal of litter, to serve for a longer or shorter series of years; this is revised usually at the same time as the forest working-plan. In such a plan all compartments are designated which may be opened for the removal of litter, subject to a suitable close-time, and the plan is based on area. Although this plan is drawn up on different principles in the different German countries, yet they all agree in excluding from the usage areas requiring protection, and especially all kinds of young woods. After this has been deducted, the remaining area is divided by the figure representing the rotation of the litter, the quotient being the area which is opened annually for the removal of litter. In order to compensate for the withdrawal of the annual felling-areas from the area open to the removal of litter, an area of the oldest woods equal to those which were closed, must be opened annually to the usage. In countries where years of scarcity of straw occur periodically, a reserved area of woodland should be set aside, which may be opened when required.

In Baden, removal of litter is not allowed in the case of broadleaved woods, till they are 40 years old; in coniferous woods—30 years, and in coppices—12 to 15 years. The shortest close time is three years. In Hesse, removal of litter is not allowed in high forest till after the first thinning, and in coppice till the second half of the rotation. In Bavaria, all woods are closed to the removal of litter till the second half of the rotation; the close-time is as follows:—

| Nature of forest. | Moist soil. | Dry soil. |
|------------------------------------|-------------|-----------|
| | Years. | Years. |
| Scots pine, larch, birch ... | 3 | 6 |
| Beech, oak, silver-fir, spruce ... | 6 | 10 |

In the Wurtemberg State forests all rights to litter have

either been commuted [by purchase, or by granting a forest area to the commune which held the right.—Tr.], or are now in process of commutation, so that no plan of operations for the removal of litter is required. In Prussia the local forest official is authorised, according to the actual requirements of the people, to open those forest areas for the removal of litter which are best able to bear it.

SECTION VII.—MODE OF DISPOSAL AND SALE OF FOREST-LITTER.

1. *Persons who may remove Litter.*

Owing to the great prejudice to wood production caused by the removal of litter, this usage is not considered as a regular form of forest utilization, as in the case of wood and other minor produce; but unless there is any actual right of user, it should be permitted only as an extraordinary concession for otherwise irremediable agricultural distress. Thus, litter is granted by a forest official only to right-holders, or by special permit. In both cases the amount granted is limited by silvicultural requirements, as laid down for instance in the plan of operations, and in cases of urgent necessity even these may be exceeded.

(a) **Right-holders.**—Rights to litter are generally unlimited in amount; even then they must be limited by the requirements of the right-holders, or by those of silviculture. It is extremely difficult to decide what are the actual requirements of the right-holders, so that silvicultural requirements may be paramount. All national-economic laws in Germany prescribe that rights to minor-produce from a forest must be so limited in volume as not to endanger the production of wood. The necessary limits are laid down in the plans of operation for litter, which have been drawn up by competent persons, and all grants of litter to right-holders must therefore be kept within the limits prescribed in these plans.

(b) **Permit-holders.**—Permits to remove litter should be given only to persons actually in need of it.

It is evident that to supply litter too liberally to farmers

tempts them to abstain from producing sufficient straw for their cattle. In years of scarcity of straw, however, exceptional assistance to farmers is justified. Thus, in the dry year, 1893, about 75,000 tons of forest-litter, from the State forests of Bavaria, were given to the farmers. The forest-owner should see to it that these aids to agriculture do not become normal.

2. *Sale of Litter.*

Litter can be sold only in two ways: by **royalty**, or by **public auction**. The latter method, however, can be adopted only if the removal of litter is regarded as a measure necessary for forest management.

If litter is sold to the highest bidder, it at once assumes the character of ordinary forest produce; farmers base their cultivation on these sales and expect them to recur annually, and thus a demand for litter arises. Attempts are being made to render the demands for litter permanent. Prices obtained for it by auction represent only the **agricultural value** of litter. If they are to guide the forester in fixing the royalty it should be remembered that the forest point of view differs from the agricultural opinion of the value of forest-litter.

There is, however, little or no objection to auctioning litter of forest weeds, the removal of which rarely injures a forest.

In fixing royalties for litter, two points must be considered, the unit of measurement to be adopted and the rate of royalty.

(a) **Unit of measurement.**—Forest litter may be measured by **area**, or by **volume**; in the former case, as a rule, one or more compartments in a forest are opened to all permit-holders who remove the litter collectively. They either divide the litter among themselves, or each permit-holder is allowed to remove a specific number of cartloads or headloads. Then separate areas usually are allotted to the different modes of conveyance (carts, wheelbarrows, headloads, etc.). When the litter is disposed of by volume, heaps of specified dimensions are prepared by the permit-holders under the supervision of the guards. The size of each heap corresponds usually to the local waggon-load (for two horses or bullocks) termed in German, *Fuder*, being equal to five stacked cubic meters.

Removal by volume in heaps is preferable to the method by area, and does less injury to the forest. The litter is then brought alongside the roads and piled in rectangular heaps of equal size; these are counted and delivered in a regular manner to the permit-holders.

(b) **Price of litter.**—Strictly speaking, the price of litter should depend on the loss of wood increment caused by its removal; for, from a silvicultural point of view, litter is as valuable as the additional volume of wood which would grow on an area, were the litter allowed to remain. Since, however, the exact amount of the loss of wood for any locality is, as a rule, non-ascertainable, this method of valuing litter must be abandoned. Another means for determining the royalty on litter is its agricultural value, which should be the minimum royalty for litter, and may be most correctly determined by selling it by public auction. The agricultural value of litter depends on the current price of straw, on scarcity of straw, and on the general conditions of agriculture. Brock says that the dearer is straw, in a year of scarcity, the cheaper forest-litter should be; in such case, old woods may be raked, pole-woods cleared by hand of litter, in strips only.

Even in cases where forest-owners for certain reasons are compelled temporarily to permit the removal of forest-litter, it should not be given gratis, though lower prices than those current for straw may be charged. This position among others was adopted by the Bavarian Forest Department, in the year of drought 1893-4.

[As regards the use of forest-litter in Britain, the following data are given :

In the New Forest, about 14,500 bundles of heather are sold per annum at 1*s.* 100 bundles, 6 bundles being about as much as a man can conveniently carry. Heather is also cut and sold in the Windsor Forest at 1*d.* a headload.

Bracken is cut, in the New Forest, from the 25th September, by the foresters, and is sold dry to farmers, who remove it from the forest, at 8*s.* a waggon-load, the cost of cutting and drying being 5*s.* In the enclosures it is much more patchy, and costs 7*s.* a load to cut and dry, but is then cut and sold between the 1st of August and the 15th September, at 15*s.* a

load. People who are very keen about bracken being well-dried pay the extra price. From 1,800 to 2,000 waggon-loads are thus removed annually. In Windsor Forest, it is sold at 2s. a cart-load (one horse), the purchaser cutting it. In the Dean Forest, there is a poor crop of bracken, it being cut too early, which weakens the rhizomes considerably. The Hon. G. Lascelles, Deputy Surveyor, New Forest, who supplied the above information, states that if bracken is cut before the end of September, as in the Forest of Dean, its rhizomes become greatly weakened, and the crop becomes gradually poorer.

We have seen above that the removal of dead leaves and other forest-litter is practised extensively in Germany. In France, this removal is termed *soutrage*, and litter is *litière*, but the benefits to the forest by disallowing its removal have been felt so long, that no rights-of-common to such a destructive practice are allowed by law, and in the standard French book on silviculture, Boppé et Jolyet, "Les Forêts," 1901, the practice (p. 123) is alluded to merely, "*Mais le silviculteur doit surtout s'opposer de la façon la plus énergique à l'enlèvement des feuilles mortes. Heureusement, ce fléau, qui sévit encore en Allemagne, est très localisé en France.*"—[Tr.]

SECTION VIII.—LIMITS TO PERMISSIBLE USE OF FOREST-LITTER.

Section I. of this chapter deals, in a general way, with the question of forest-litter, and describes its important action upon the well-being of the forest and on the production of wood; it proves also that the removal of the litter is most injurious, whenever it is necessary for the soil and crop of trees in question. No further remarks on these points, therefore, are required here, but those cases will be explained, in which the removal of litter does the least possible harm to the forest, or even may be useful to it.

1. *Locality.*

Dead-leaf litter may be removed from places, where its presence is indifferent, or superabundant; from areas not used for the production of trees, such as forest meadows,

glades, roads, ditches, etc. ; it should be removed from areas used for tree-growth, but which are covered deeply with dead leaves, depressions, or freshly-sown compartments. All weed-litter may and should be removed, wherever it is a hindrance to natural regeneration, or to the development of forest plants ; also litter containing numerous larvæ or pupæ of destructive insects. Woods growing in localities, where the climate is cool and moist, and where the rainfall is heavy are chosen in preference to dry localities for the removal of litter.

2. Soil.

Soil that is mineralogically rich can withstand the removal of litter better than poor silicious soil ; on poor soils the effect of this removal is felt soonest and most severely.

Schwappach states that in spruce woods of the best quality, the annual removal of litter even for long periods has no bad effects. Laspeyres found that the use of litter on good soils is indifferent ; that in years of drought litter may be taken from inferior soils. Bleuel* showed that annual removal of litter during periods of 23 to 30 years caused a falling off of increment in old beech woods, on inferior soil, of 32, 39, 42 and even 56 per cent., while on good basalt soil (Rhône) the loss was only 8 per cent. Under similar conditions, the loss of increment in Scots pine woods of good quality was 7·5, 9·3 and 10·9. Removal of litter every three years in the Spessart from beech woods caused a loss of increment of 13 per cent., every six years, of 10 per cent. These observations showed further, that the loss of increment increased steadily from period to period.

The condition of the subsoil is also important ; if it is of boulders, gravel, or of rock full of cracks, and also the ground is sloping, the water descends to such a depth, as to be useless for the forest. The ill effects of the removal of litter from soils full of springs or from deep soils are felt less ; its bad effects are nowhere greater than on shallow soil, with a subsoil of gravel, etc.

* Bleuel, "Über den Einfluss der Streunutzung auf die Massenproduction des Holzes."

3. *Climate.*

In cool, moist climates and in localities sheltered from the wind, litter decomposes slowly; sometimes it accumulates to such an extent, that its removal may be even advantageous for the trees. Such places should be opened, first of all, for the removal of litter.

4. *Species of Tree.*

The removal of litter is the less injurious for any species of tree, the better the locality suits it, and the less the productivity of the locality, depends on the soil-covering of dead leaves, moss and humus. The question is therefore strictly local, and must be decided afresh for every change of locality.

5. *Age of Crop.*

The removal of litter is most prejudicial to young thickets and poles; on the contrary, for mature crops of trees, at the commencement of natural regeneration, its removal facilitates the germination of the seed, [and enables the seedlings to become rooted firmly in the mineral soil, when they are less exposed to perish from drought than if rooted merely in the litter.—Tr.]

6. *Density of Crop.*

There are crops of such a density, that encourages an unproductive accumulation of partly decomposed humus; in dense spruce and silver-fir woods this bad condition of the soil arrests the growth of the trees. In such cases, thinnings are beneficial and so is the removal of the cushions of moss. Also in crops of pines, oak and larch, there is often a dense soil-covering of mather or bilberry-plants, that induces the formation of sour soil and of a pan; removal of the soil-covering and breaking up the soil is thus beneficial.

7. *Intensity of the Usage of Litter.*

The shorter the period between consecutive removals of the litter, the greater the injury to the crops. Such an interval may be termed rotation of the litter-raking.

It is also of great importance when the litter is removed, whether only the uppermost layer of undecomposed leaves, etc., is raked together, or the humus and mineral soil below is also affected. The deeper the raking the more injurious it is.

Whenever deep raking is repeated frequently, the soil becomes dry; it may become so firm and hard that the next year's dead leaves, either are blown away by the wind, or do not coalesce with the soil for several years. Therefore, only the upper and undecomposed, or slightly decomposed, layer should be removed, and the moss removed only in strips.

8. *Season for the Usage.*

The removal of litter is more prejudicial during spring and summer; less so in autumn before the leaves fall, and least of all after the fall of the leaves.

Raking, before the leaves have fallen, removes dead foliage that has lain for a year on the ground, so that in order to secure a given quantity of litter the rake must go deeper into the decomposed humus. When raking is done after leaf-fall, some of the freshly fallen leaves remain on the ground.

SECTION IX.—VALUE OF FOREST-LITTER FOR AGRICULTURE.

The very existence of agriculture depends on a sufficient supply of manure. Both agricultural and forest land require that all soil-constituents which the crops have taken from them—in fact their own ash-constituents—should be restored, or they will become sterile. In order to meet the constantly increasing demands on the soil made by agricultural crops, every farmer besides using imported artificial manure, endeavours as much as possible to increase the supply from his own farmyard. In order, however, to obtain more farmyard manure, more fodder-crops must be grown, and any scarcity of hay, clover, etc., must be met by using straw. But stalled cattle require litter partly to afford them dry bedding, and partly for the absorption of their excreta; when therefore there is not sufficient straw for this purpose, a substitute may be found

in dead forest leaves, needles and weeds. There are in Germany many farms where all the straw is used for fodder, or sold, and only forest litter used for bedding. Hence during the present century the belief has spread, that forest-litter is more or less indispensable for the farmer, and practically the forest owner is obliged to supply it.

The questions must therefore be discussed, first, what is the agricultural value of the different kinds of forest-litter; and secondly, under what circumstances forest-litter becomes a real necessity for agriculture?

1. *Agricultural Value of Forest-Litter.*

The agricultural value of the different kinds of forest-litter depends on their value as manure, and as material for bedding. Some other factors are also important, such as the physical properties of litter, its effect in rendering soil porous, etc.

The amount of contained ash-constituents (phosphoric acid, potash, etc.) and of nitrogenous compounds decides the manurial value of forest-litter. All forest-litter, except ferns, is poorer than is straw in ash-constituents. The observation of Wolf and Ebermayer* as regards the percentages of mineral constituents in the ash of forest-litter are given below:—

| Kind of litter. | Potash. | Phosphoric acid. |
|------------------------------|----------|------------------|
| Ferns and rushes | 22 to 24 | 5 to 6 |
| Different kinds of straw ... | 7 „ 11 | 2 |
| Moss and broom | 5½ „ 6½ | 1½ to 3 |
| Dead leaves | 3 | 3 |
| „ needles | 1½ to 2½ | 1 to 2½ |

Forest-litter is sometimes richer in nitrogenous matter than is straw. It is, however, much more valuable as bedding material than for its intrinsic manurial value. Good bedding material should absorb and retain the excreta of farm animals readily. With the exception of dry moss and peat, all other forms of forest-litter are inferior to straw in this respect. Leaf-litter

* "Die gesammte Lehre der Waldstreu," p. 109.

and dead ferns come next to these in value, while coniferous needles and heather are less suitable. The absorptive power of woods and branch-litter varies inversely with their more or less woody nature.

[Ebermayer states that animal manure containing much ammonia has a basic action; vegetable *débris*, except when mixed with lime or ashes, is acid.—Tr.]

The absolute value of the various kinds of forest-litter depends chiefly on their value as manure and bedding, but, as noted above, other factors also intervene. Taking all these into consideration, the kinds of litter may be classed as follow:—

1. Moss, either alone, or mixed with needles.
2. Straw.
3. Dead ferns.
4. Dead leaves, of beech, sycamore, lime, alder, and hazel.
5. Coniferous needles, and dead leaves of species not included in 4.
6. Weeds and branch-litter.

Moss, when used dry, is the best of all forest-litter: it is more absorptive than straw, and contains more nitrogenous matter, phosphoric acid, and potash. Its rate of decomposition varies with the species of moss. Mosses that occur usually in spruce and silver-fir forest become converted rapidly into a fairly light soil; the more fibrous kinds of moss, which grow on swampy ground, decompose more slowly.

Dead ferns also form a valuable kind of litter, containing not only the largest quantity of ash, but also, when thoroughly dry, being highly absorptive of liquid manure. Ferns also rot rapidly, and improve the porosity of a soil.

Litter of dead leaves of beech, lime, sycamore and hazel is very nearly as valuable as straw; when used for manure, however, unless thoroughly rotten, it is rather harmful to light soils, in which it forms stratified layers, does not decompose uniformly and often renders the soil too loose. Thus, light, sandy soils manured with it often become superficially dry, and the leaves and dung applied to them are blown about by the wind.

Dead needles, taken alone, are inferior to dead leaves of broadleaved trees, both in their ash-constituents and power of absorbing dung. As, however, there is generally a certain amount of moss with the needles, this increases their value as litter, and hence, a mixture of dead needles and moss is preferred to dead leaves.

The branches of conifers form a litter very variable in value.* If it contains only the twigs and last year's sappy shoots of the trees, and all woody pieces less than the little finger in thickness are excluded carefully, this litter in many districts is considered valuable for stiff soils. It is not used in loose, sandy soils, or when very woody.

Heather, as well as litter from other weeds, is inferior agriculturally to the kinds already referred to. It varies, however, in value, according as only the upper half of the plants, or the whole plant is used; if cut when young, or when old and woody; in the spring, or the autumn. Sods of heather, including the roots and humus around them, as well as the whole plant, are much more absorptive of dung than the heather alone; but their removal is never permissible under careful forest management.

2. *Cases where Forest-Litter is Indispensable for Agriculture.*

The condition of agriculture is so variable in different countries, and the intensity with which land is farmed differs so considerably even in one and the same district, that to answer the above question requires a special consideration of each case. The main factors of general application are;— the natural productiveness of the soil, climate and season, size of farms, density of population and comparative knowledge of agriculture by the farmers. If any special case is considered under each of the above heads, a decision may be formed as to the indispensability or otherwise of forest-litter.

Within certain well-defined limits forest-litter may be considered indispensable to agriculture:—in the case of inferior soils and unfavourable climates; in years of scarcity of straw and fodder; in over-populated districts where landed pro-

* Cf. Part II.

perty is much subdivided and garden-husbandry or the cultivation of potatoes extensively followed ; or where, in fairly productive localities, the land is being over-cropped.

In all other cases, and especially where bad farming prevails, and the farmer from obstinacy and indolence declines to adopt improved agricultural methods, there can be no real necessity for concessions of forest-litter.

CHAPTER IV.

DIGGING AND PREPARATION OF PEAT.*

SECTION I.—GENERAL ACCOUNT.

IN the cooler parts of the temperate zone there are numerous areas, frequently of large extent, characterised by an excessively wet soil and a specialised flora, and generally known as peat-moors or bogs. Most of these moors yield peat, sometimes called turf, as in Ireland and the English fens.

Extensive peat-bogs are found in all northern countries, but not in southern countries. They are most abundant in Ireland, Russia, Scandinavia and Germany, occurring in river-valleys, along the banks of lakes, on high plateaux and ridges in mountainous districts (such as the Harz, Thüringerwald, Erzgebirge, Rhône-valley, Schwarzwald, Alps, etc.), also on the high Swabian plateau in Bavaria bordering the northern declivity of the Alps, where there are at least 500 square miles of peat-bog; there are also extensive bogs in the plains of North Germany. This latter district, extending northwards into Denmark and westwards into Holland, is the richest peat-producing tract of land in Europe, for bogs over 1,500 square miles in extent, which occur in East Friesland, do not probably exist elsewhere.

[There are in Ireland 1,861 square miles of peat-bog, with an average depth of 25 feet, chiefly in the counties of Mayo, Galway and Donegal,† but the area of bog in Great Britain is not given in the agricultural returns, though peat is dug for fuel in the Scotch and Welsh hills and mountains, in the Yorkshire and Lincolnshire wolds and moors, and in the fens of East Anglia and Somersetshire.—Tr.]

* Baumann, "Die Moore u. die Moorkultur in Bayern." Männel, "Die Moore des Erzgebirge." Honold, "Die Torflager in Württemberg."

† [The area of the bog of Allen in Ireland is about 370 square miles. See "The Irish Peat Question." T. Johnson, "Proceedings of Royal Dublin Society," Nov., 1899.—Tr.]

Much has been written at different times about the composition of peat; recently, Wiegmann, Sendtner and Braun, Müller and Ramann,* all agree that it consists chiefly of vegetable substances, the decomposition of which is arrested by excessive moisture: the only questions still unsolved being whether the exclusion of air by water alone suffices to retard the decomposition of the vegetable remains, or whether the antiseptic action of free humic acid is also indispensable for this purpose, finally, whether frost in any way affects the formation of peat.

Since, during the formation of peat, air is excluded by the presence of water in excess, the carbon contained in vegetable *débris* cannot be converted into carbon-dioxide, but plants in the deeper layers of a peat-bog part with their oxygen and become carbonised.

Permanent and excessive moisture causes the formation of peat, and this, according to Sendtner, may be due to:—

(a) **Impermeability of the soil**, when the bed of a peat-bog is formed of clay, loam or marl. This is the usual cause of peat-formation.

(b) **The porosity of the soil**. When the sub-soil consists of permeable sand or gravel (as in the case of several Dutch and North German bogs) the situation being either on a level with an adjoining lake or the sea, or slightly elevated above them, the soil is maintained constantly wet by the sub-soil water.

(c) **Inundations**, when repeated annually and lasting for some time.

(d) Finally, certain mosses, *e.g.*, *Sphagnum*, *Dicranum*, cause moors to form, as they become saturated with water and spread centrifugally from their original position.

[Some European peat-bogs are of great age, and contain remains of extinct animals (Irish elk, etc.), also of arctic flora, dating from the close of the Glacial Period.—Tr.]

* Ramann, "Moor u. Torf, ihre Entstehung u. Kultur," 1888. Sendtner, "Vegetationsverhältnisse von Südbayern," p. 641; Sprengel's notes on pp. 37, 41, of Lesquereux, "Untersuchungen über die Torfmoore"; also Braun, "Die Humussäure und die fossilen Brennstoffe," Darmstadt, 1884.

SECTION II.—CLASSIFICATION OF BOGS.

Peat-bogs vary considerably in appearance, being composed of various plants, and containing different kinds of peat. Thus, in North Germany, high peat-bogs (*Hochmoore*), are distinguished from fens (*Grünlandsmoore*, or *Brücher*); in South Germany, chiefly in the Bavarian and Swabian plateau, there are high peat-bogs and morasses (*Wiesenmoore*). Lesquereux classifies Swiss bogs as super-aquatic and infra-aquatic, corresponding to high peat-bogs and morasses.

1. *High Peat-bogs.*

High peat-bogs, termed also peat-mosses, peat-moors or wolds, are characterised chiefly by the prevalence of peat-moss (*Sphagnum*), and a dense growth of heath plants (*Calluna*, *Erica*, *Andromeda*, *Myrica* and *Vaccinium*); in South Germany, also, the mountain-pine (*Pinus montana*), birch and willows appear on these bogs, and the spruce on their borders. These plants grow gregariously on extensive areas and form most of the peat. Such bogs are characterised by a gravelly or clayey subsoil and by the convex, arched shape of their surface.

The arching of their surface (from which the term high peat-bog arises) consists in a gradual, upward slope from their margins towards their centre. This upward slope is sometimes inconspicuous, but often reaches 20 to 23 feet, or even 33 feet, as in the Emsmoor and in East Prussia. High bogs originate at their highest point from which they tend to spread in all directions; this is due to the hygroscopic nature of the moss (*Sphagnum*), so that water constantly flows from the margins of a bog, rendering the surrounding land swampy. In this way even permeable soil may become covered with peat, the bog consequently spreading. The wettest parts of high peat-bogs are their borders.

2. *Morasses or Meadow-bogs.*

Morasses, as in the Bavarian plateau, have a completely different flora from high bogs. In the first place there are no

peat-mosses, heath-plants or mountain-pines; in their place species of *Hypnum* and sour herbage (*Eriophorum*) appear, which are their chief components, while stunted Scots pines, alders and birches are here-and-there disseminated. High bogs are distinguished readily, even at a distance, by the appearance of the heather and red-tinted *Sphagnum*, but morasses resemble extensive sour meadows.

In the Bavarian plateau, morasses have a subsoil of boulders and gravel brought down from the mountains and usually covered by a thin layer of amorphous calcareous marl, termed locally *Aln*, which forms an impermeable base for the bog. The surface of morasses is horizontal, and they are more frequent in low lands near rivers than in depressions among hills, where high bogs prevail; they are more extensive than the latter in southern Bavaria.

3. *Fens*.

The fens of the North German plain have much the same appearance as the morasses of the Swabian plateau, as they are also formed of sour herbage, such as rushes, sedges, cotton-sedge (*Eriophorum*) and moss; but according to Sprengel, they do not yield actual peat, but a muddy humus which is dredged from them.

These fens are often of large extent, chiefly near the water-courses, but are much less prevalent in North Germany than the high moors.

[The fens in East Anglia, when near the low chalk hills of that region, as at Mildenhall, sometimes rest on beds of marl formed of the *débris* of water-plants (*Chara*) incrustated with carbonate of lime from the brooks running into them, peat also occurring on the Kimmeridge and Oxford clays. In all these cases, the vegetation resembles that of the fens and morasses of Germany. Professor Seeley states that in East Anglia, at the base of the layers of peat there are embedded forests of Scots pine and yew, separated by marine clays.—Tr.]

Although, as a rule, the different kinds of bog preserve their distinctive character, yet there are many intermediate forms.

Thus fens and morasses may contain patches of high peat-bog, and frequently pass completely into the latter form, as in many North German districts.

Besides the above-mentioned kinds of bog, there are **seaside-bogs** and **forest-bogs**. The former are found on low lands along the seaside, which either are inundated occasionally by the sea, or into which brackish water infiltrates, or are caused by the damming of the mouths of rivers or small water-courses by the tides. Forest bogs are those in which a great number of trunks of trees in more or less good preservation (bog-oak, etc.) are imbedded. These trees are sometimes erect, as in the Wicklow mountains, and sometimes lying horizontal, as at Sunningdale, in Berkshire. Both these forms of bog, however, come under one of the headings already mentioned.

The peat found in the different bogs varies greatly in its character, according to the degree of decomposition it has undergone, its greater or lesser contents of humic acid and carbon, the vegetable *débris* of which it is composed, and finally the comparative quantity of earthly material which is mixed with it. Some peat resembles lignite both in appearance and economic value, whilst other kinds hardly can be distinguished from slightly decomposed vegetable remains. So many bogs are intermediate to these extreme forms, that it is difficult to characterise even a few of them. They are distinguished frequently by means of the plants from which they are formed, such as heather-peat, moss-peat, wood-peat, sedge-peat, etc., but thus no true standard of quality can be obtained, as each variety may represent peat of every possible quality. The best way to judge of the latter is to consider the degree of decomposition of the vegetable *débris*, the degree of cohesiveness of the particles of peat and their density. In this way, the following kinds of peat may be distinguished :—

(a) **Amorphous** or **Black peat**, a dark brown or blackish peat with silky lustre on a clean-cut section, heavy, generally rich in carbon, when dry, breaking with a conchoidal fracture. This peat is found generally in the deeper strata of a bog, and the plants of which it is formed are scarcely recognisable.

(b) **Fibrous or Brown peat**, of a loose fungoidal structure, in which the component plants, grass, moss, heather, reeds, sedge, etc., are generally recognisable; it is usually of a lighter colour than black peat (yellowish to dark brown), less heavy, more or less carbonaceous, when dry does not crumble and usually occurs in the upper strata of a bog.

(c) **Dredged peat**, a more or less tenaceous black peaty mud, forming the lowest layer in morasses, showing no visible vegetable structure; when dry, it has a peculiar lustre and is heavy; owing to its muddy character it generally is moulded into various shapes.

Between dredged and black peat (the best kinds) and brown peat, there are numerous intermediate varieties, the quality of which is considerably modified by the amount of earthy admixture they contain. This earthy matter consists partly of the ash-constituents of the peat-forming plants, and partly is introduced accidentally by inundations, etc.

SECTION III.—METHODS OF HARVESTING PEAT.

Before undertaking to work a peat-bog, a full estimate should be prepared of its quality and its probable volume, in order to determine whether the outlay of capital expended in removing the peat will be covered by its value and that of the cleared land.

1. *Quantity of Peat.*

The following data are required to estimate the quantity of peat in a bog: the area, depth, amount of shrinkage of the dried peat and the loss of peat during its extraction.

(a) The **area** of a bog should be ascertained by surveying it.

(b) The **depth** may vary considerably at different points of a bog, which is not unfrequently intersected with one or more layers of sand, loam or trunks of trees. In order to become acquainted with the nature of the bog, it should be divided into a rectangular network, the points of intersection of which may be about 27 yards (25 meters) apart, and are marked by numbered stakes. Three methods can then be followed; either strong poles are driven down at each numbered point to the

bottom of the bog, pits 2 to 3 yards broad are dug, or a peat-borer is used.

Driving poles into bogs may lead to false inferences, if beds of marl or trunks and stumps of trees, etc., are imbedded and prevent the poles from reaching the bottom of the bog. Digging pits is often impracticable owing to the accumulation of water and always involves much labour and expense, but this method affords the best possible insight into the nature of the bog and must be employed to ascertain the quality of the peat. It is best to use the peat-borer, as this generally gives satisfactory results and saves much labour. Since, however, few bogs are level at the surface and their bed is often undulating and irregular, levels should be taken all over the surface of a bog, the levels of the bottom and top of each point of intersection being fixed with reference to a horizontal plane through the highest point in the bog. This levelling will show what is the contour of the bog, a knowledge of which is requisite before its drainage can be undertaken.

(c) With the help of the above factors, the contents of the peat-bog may be estimated in cubic feet. In order, however, to estimate how much marketable peat there may be, a deduction must be made for **shrinkage**. For as soon as a bog has been drained, it settles down and shrinks the more, the more thorough the drainage. The amount of shrinkage must be calculated by experiment.

Thus pieces of peat of the ordinary dimensions are cut from several trenches and thoroughly dried, their volumes being calculated before and after drying and the difference between them being the amount of **shrinkage**, which is generally from 30 to 50 per cent. of the volume of freshly cut peat.

(d) Finally the loss of peat during extraction must be estimated: this varies in quantity according to the skill of the workmen, the quantity of stumps or stems of imbedded trees and the cohesiveness of the peat, for the better kinds of peat are much more brittle than inferior fibrous peat.

During frosty weather in winter, the walls of the open peat-trenches frequently crumble considerably; besides this waste, frequently ridges of peat remaining between the trenches

cannot be utilized. Thus a loss of peat occurs, often 25 or 50 per cent. of its whole volume. If, however, this otherwise wasted material can be moulded into turves, no loss need accrue.

2. *Quality.*

The quality of the peat is ascertained in the above-mentioned manner, both as regards its efficiency as fuel, and the possibility of thoroughly draining the bog.

It has already been remarked that the quality of the peat varies in the different strata of the bog, the best peat being, as a rule, at the base of the bog and the inferior kind at its surface. In order to ascertain the nature of the peat throughout the bog, several experimental trenches are dug: the refuse is set aside and the fibrous peat stacked apart from the black peat, the relative proportion of each kind being calculated; the peat at the base is then dredged out and each kind analysed.

As the value of peat depends on the quantity of combustible matter in it, which is greater the less water or ash the peat contains, the analysis is directed chiefly to ascertaining the quantity of water and ashes in the peat. The contents of the peat in bituminous substance and uncombined carbon, which is always a test of its value, may be found by extracting them with sulphurous ether.

The value of a peat-bog depends also on the possibility of draining it. If a bog can be thoroughly drained within a year from the commencement of working it, the admission of oxygen from the air will more or less quickly convert the insufficiently decomposed and less valuable peat into rich black peat which is the most valuable kind. Well-drained peat also crumbles far less than when the bog is undrained.

It is evident that if a bog is to be properly utilised, it should be worked in accordance with a fixed plan prepared beforehand; this plan specifies how much peat should be dug yearly, when the digging is to be commenced, in what direction it is to be continued, according to what principles it is to be drained and the best lines for transport. Wherever there

is an intention of utilizing the peat and then converting the bog into a forest or meadows, so much of it will be dug each year in accordance with the purpose in view, to which the utilization of the peat is merely subsidiary. If, however, it is intended to have a permanent supply of peat, only so much should be dug yearly as the bog produces in a year.

Fresh peat is produced regularly in all bogs where the conditions remain unaltered. Thus some bogs produce annually layers of peat 6 or 8 inches thick, or even thicker; others a mere film of new peat, and others none at all.*

The first condition for a renewal of the peat is a drainage system by means of which the parts of the bog from which the peat has been dug can be irrigated properly. If these portions can be kept submerged continually, but not too deeply (about 2 to 4 inches), whilst here and there ridges and mounds remain above water-level, the water containing humus and the base of the bog not being completely freed from peat a continual production of peat may be anticipated. In order to secure these conditions, the useless upper layers of peat and other refuse are thrown on the cleared areas and trenches, care being taken to keep these latter inundated.

The mode of reproduction of a bog cannot be explained in a general manner, but only observed on individual bogs, whilst any change in the drainage of the surrounding land may greatly affect matters in this respect. As, therefore, a long period is required for such observations, during which changes in the water-supply may occur and the rate of production of peat vary in different parts of the bog, it is rare that working plans for a bog take into consideration its reproduction. It is, therefore, considered sufficient to prepare a plan for from 50 to 100 years, according to the extent of the bog, the demand for the peat, and amount of labour available; a fixed quantity of peat is thus supplied annually, whilst the cutting proceeds in a proper direction. In the latter respect, it is customary to commence operations at the highest part of the bog, if it is intended that the peat shall be reproduced, and thence to proceed gradually to its lower parts.

* For the rate of growth in various moors, see Sendtner, *op. cit.*, p. 616.

SECTION IV.—DRAINAGE OF BOGS.

1. *General Account.*

Peat can be utilized only after a bog has been partially drained. It is chiefly small bogs resting on a sloping bed which can be worked without draining; drainage is always necessary in the case of large bogs. The object is not to drain the entire bog, but only that portion which it is intended to work immediately, and to such an extent that the peat may be readily dug and dried. The remainder of the bog should be kept thoroughly wet in all cases where the production of the peat is intended, and the peat also protected from being frozen*; this is also frequently useful when the land already freed from peat is to be cultivated.

All parts of the bog which are not being utilized should be kept thoroughly wet during winter, or the peat will be seriously injured by frost. When wet or damp peat is frozen it does not become compact again on being dried, but crumbles. If the cleared bog is to be planted with trees or converted into meadow-land, it is not advisable to drain the bog completely, but only to remove the superfluous water.

The method of draining a bog depends essentially on its situation and nature; one or other of the following methods being adopted:—leading water away in drains, cutting off the water-supply, collecting the water in drains or tanks, or causing the water to sink through an impermeable subsoil.

2. *Ordinary Drains.*

The usual method of draining is to lead the water from the bog in ordinary open drains. It is then essential that some land near the bog is on a lower level than its bed; this generally occurs. The levels taken of the bog and the immediately surrounding country show the difference of altitude between the lowest point of the bed of the bog and that of the external land, and the gradient of the line joining these two

* [Cranberry bogs in N. America are inundated regularly when threatened by frost, in order to protect the plants.—Tr.]

points. This is the line of greatest fall, and should be the direction of the principal drain.

It should be noted that a steep gradient is desirable only outside the bog; within the bog the gradient of the drains should be less the more water the bog contains. Digging the principal drain is commenced at its lowest point outside the bog; it often suffices to continue this drain up to the bog, but, as a rule, it should be conducted to the lowest point within the bog. In case a brook runs through the bog it may often be used as the principal drain after some cuts have been made in it to improve the flow of water. If the bed of the bog slopes down towards a neighbouring river or brook, this slope affords the best gradient for the drainage. If, however, the bog lies in a depression surrounded by higher land, it is a question of expense whether to cut through the latter or construct a tunnel to serve as a drain. The dimensions of the main drain depend on the gradient and the quantity of water to be removed. It is not generally necessary to drain down to the bed of the bog. Too broad or deep drains often injuriously dry up the bog and are extremely costly both in construction and maintenance. Where the drain leaves the bog a simple sluice-gate should be constructed in order to retain sufficient water in the bog during winter. In the case of small bogs and drains, instead of a sluice-gate, the inlet into the main drain is blocked in autumn with peat.

If there is much change of gradient in the bed of a large bog, several draining trenches are cut through the latter. It is often advisable to cut these drains from a certain point in the bog, and then lead them outwards in diverging directions, which generally cross one another at right angles.

Whilst generally the main drain is completed once for all, the subsidiary drains are dug gradually during the progress of removal of the peat. They are generally at right angles to the main drains and are intended to drain only that portion of the bog which is being worked. They are naturally smaller than the main drain.

In the extensive bogs of Holland, Friesland and Bremen the main drains serve not only for drainage, but also for the purpose of communication by barges and conveyance of the peat; they are frequently 26 to 32 feet broad.

3. *Drains for Cutting off the Water from Bogs.*

There are frequently small watercourses which run into a bog, or water runs down a slope into it. If, then, trenches can be dug so as to cut off the water-supply from the bog, they are very serviceable as an aid to ordinary drains, but will not suffice alone to drain the bog.

4. *Collecting-Drains and Tanks.*

A large number of bogs are supplied with water by infiltration from neighbouring watercourses. If, then, the bog lies above the level of the water it is possible to drain it in the ordinary manner; this cannot be done if it is on about the same level as the water. Usually more extensive works are then required (which are too costly where peat-digging is concerned), in order to exclude inundations from the bog, or remove the water from collecting drains by means of pumps and hydraulic engines. Only when the inlet of water is inconsiderable can water, which collects in the drains during the night, be removed by manual labour. The construction of a sufficiently large tank near the bog to receive the water can be undertaken only exceptionally.

5. *Piercing an Impermeable Pan.*

If a bog should rest on a thin bed of loam or clay, below which is an impermeable stratum, or pan, of gravel or sand, the simplest method of draining it is often to bore or break through the pan and thus allow the water to sink below it. If, however, the shaft through the pan is made at the deepest part of the bog its drainage may be too thorough, and thus injuriously affect the peat.

SECTION V.—HARVESTING THE PEAT.

The removal of the peat may be effected in various ways. A distinction is thus made between peat dug by manual labour (*Stichtorf*), peat which is moulded into shape (*Modeltorf*) and peat removed and prepared by machinery (*Maschinentorf*).

1. *Peat Dug by Manual Labour.*

Only fairly compact peat can be dug by means of spades, and the pieces, termed *turves*, are then dried in the sun and by exposure to the air. The different operations in this case are the preliminary works, and digging, drying and storing the peat.

(a) **Preliminary Works.**

i. *Subsidiary Drainage.*

After the main drain and the most important side-drains have been dug, further subsidiary drainage must be done annually. This is effected by making a trench a little way from where the peat is to be dug, parallel to the line of digging and perpendicular to the main drain, so that either the whole or a portion of the area to be dug in a year may thus be drained. As soon as the season's digging is over, the junction of each of these drains with the main drain is closed in order to keep the bog sufficiently moist.

ii. *Laying Out the Line for Digging.*

The area where the peat is to be extracted in accordance with the plan of operations, should then be measured and marked out with shallow trenches, so that the workmen may know where to dig.

As a rule, the peat should be dug in successive years from immediately adjoining areas and no wall of peat left standing between them, which is usually a sign of bad management, though sometimes necessary where there is a superfluity of water. Each year's area should consist of a long, narrow strip, parallel lengthwise to the subsidiary drain. Such a shape allows a number of men to work simultaneously, renders drainage by means of a single trench possible and allows sufficient room for drying the turves, which are generally piled on a strip of land previously marked out and adjoining the digging trench. All vegetation should be cleared from this strip, so that the turves may be piled easily and exposed thoroughly to the air.

iii. Laying out Roads.

The turves must either be dried on land adjoining the bog, or on the bog itself, and then removed. In both cases, roads are necessary, which should be made on the driest part of the bog, be as permanent as possible and cross the drains only when this is unavoidable, in order to avoid the expense of bridges. Roads should be made of fascines and sifted gravel whenever they traverse wet ground. If the turves are removed in wheelbarrows from the digging-trench to the drying-ground, only a narrow pathway is required.

iv. Removal of Wood.

On many bogs a certain number of trees are growing (mountain or Scots pine, alder, birch, etc.), and their usually spreading roots often interfere considerably with the digging. These trees should be felled a year before the turves are dug, and their main roots extracted.

v. Management of Labour.

Labourers employed in digging turves should be divided into parties, as in the case of forest work. According to the methods employed for digging and drying the turves, three, four or even more workmen form a party. The digging-ground is then sub-divided into as many sections as there are parties of labourers, provided a certain length is not exceeded, in North Germany usually 2 or 3 yards (meters), and in South Germany 4 or more yards, per man. These measured lengths are staked out, numbered and distributed among the parties.

(b) Digging the Turves.*i. Season.*

It has been stated already that peat is damaged by frost, and this is the case both with uncut peat and turves. One or two degrees below freezing-point is sufficient to do the damage. Frozen turves do not shrink after thawing, but dry the same

size as when frozen; they are, therefore, very porous, form inferior fuel, and crumble easily. Digging turves should not therefore commence until there is no longer danger from late frosts.

Although it may appear profitable to dig turves during dry spring weather, yet experience proves that a single late frost will damage the turves, so as to nullify all the advantage of early work. In countries, therefore, with a mild climate, digging turves should be commenced about the beginning of May, in mountainous and northern countries, from the middle to the end of May. The work should stop early enough to allow the turves to dry thoroughly. This depends also on the local climate and especially on the humidity of the air. Digging turves generally terminates about the end of August, if the turves are dried out of doors. When they are dried artificially, the work may continue for a longer period.

ii. *Size of the Turves.*

The size of the turves depends on the compactness of the peat and the time required for drying them. The lighter and looser the peat, the better it holds together during digging and drying, the more quickly can the turves be dried and the larger they may be. In the case of black, amorphous peat, the turves are smaller than with brown peat.

iii. *Implements.*

All the implements used for digging turves are modifications of the garden spade.

The Frisian spade (Fig. 389) is used for digging vertically; the spades (Figs. 390, 391) are used for digging horizontally; they have short handles, but very sharp and perfectly flat blades. The peat-spade (Fig. 390) is in common use. Fig. 391 is a two-bladed spade with one blade at right angles to the other, in order to loosen the turves on both sides at once; it is used in the Rhine provinces. Fig. 392 is a spade used for vertical digging in Upper Bavaria, the turves being cut on all sides with it. Fig. 393 represents a spade used in North

East Germany to remove the useless superficial turf and sods of earth. A three-pronged fork resembling an ordinary dung-

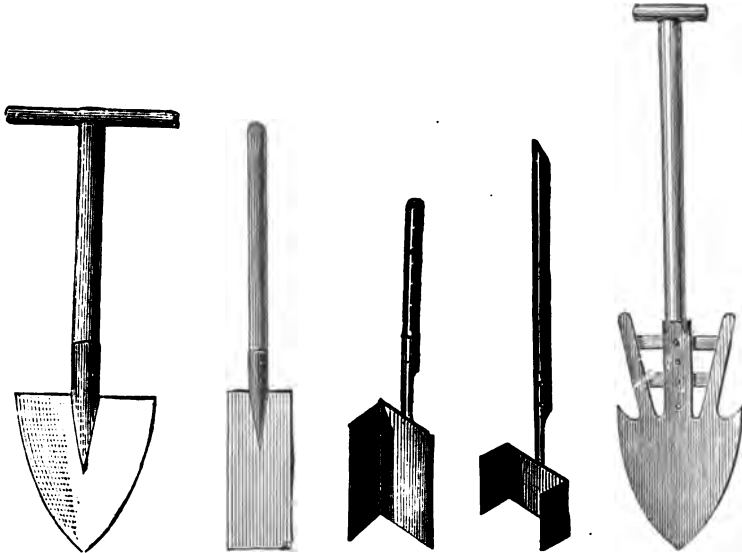

Fig. 389.

Fig. 390.

Fig. 391.

Fig. 392.

Fig. 393.

Implements used for digging peat.

fork is used generally for putting the turves into barrows or carts for transport.

iv. *Digging Turves.*

There are two methods of digging turves, termed respectively the **horizontal** and **vertical** methods. The former method is almost universally employed in North Germany, and is common in the Rhenish Provinces and South Germany. The vertical method is practised in some Upper Bavarian bogs and in the Baltic provinces. In the **horizontal** method, a workman beginning at the top edge of the wall of peat, cuts the vertical lines of a turf with the Frisian spade, whilst another workman standing in the trench, cuts the turf horizontally and sideways from the bank of peat.

In the **vertical** method, the workman standing on the top of the bank of peat cuts each turf free by one vertical or slightly oblique stroke of the spade (Fig. 391) and tears it off

from below, raising it with the same spade on to the bank of turf. As by this method the turf is broken off above and below, it has not a regular cubical shape; control is thus rendered more difficult, while there is more refuse from crumbling than in the horizontal method. At the same time the vertical method is less laborious and cheaper than the other. According to the skill of the workmen and the difficulty of cutting the peat, with horizontal cutting, 3,000 to 5,000 turves may be cut in a day, and with vertical cutting under favourable circumstances 6,000 to 7,000 turves. The vertical method is obligatory whenever the bog is insufficiently drained.

Before beginning to cut the turves the topmost layer of soil must be dug up in sods, as long or double the length of the turves, by means of the Frisian spade, or the spade shown in Fig. 398; these sods should be removed from the bog in wheelbarrows or carts.

The methods of cutting turves also vary, in the case of either horizontal or vertical cutting, according as the peat-bank is cut in **continuous** or **alternate strips**.

When the turves are cut in **continuous strips**, a commencement is made on the longer side of the area marked out for the year's cutting, and strip after strip of peat is removed until the work has been completed. In this case, the work going on continuously down to the bed of the bog, there is either a vertical bank of peat left, or this bank may be in steps and the work proceed by cutting first from the top-most step, then from the second step, and so on. In this case the turves are removed from the bog as soon as they are cut, so as to leave room for the workmen to dig.

When the turves are cut in **alternate strips**, they are stacked close to the cut, like a wall, the strip on which they stand being left uncut and a new strip commenced immediately beyond it. In this case also, a deep bog cannot be at once cut to its full depth, but the work must be done in two operations. As soon as the stacked turves are dry and have been removed, the work of cutting the intermediate strips is undertaken.

Cutting in alternate strips is cheaper than in continuous

strips, as a separate labour force is not then required for removing the turves to the drying-ground; this method is also especially applicable when the bog is wet or insufficiently drained, also when it is superficial and can be cut in one operation. It has, however, the disadvantage that the turves are all from the same level and is not advisable for deep bogs.

v. *Obstacles to Cutting.*

Besides the water, which may prevent the cutting going down to the bed of the bog, various foreign bodies are imbedded in the peat, forming so many obstacles to the digging; among these are stones, beds of sand or marl, roots and stems of trees, etc. Stones are frequently found in morasses and fens; besides interrupting the cutting they injure the implements. Layers of sand and marl often cause temporary flooding and must be cut through to let the water pass. Imbedded roots and stumps of trees are often serious obstacles in high peat-bogs. When these are stumps of resinous conifers, they are usually quite undecomposed* and must be removed completely. Large quantities of peat are sometimes wasted owing to the presence of stumps and long side-roots. Superficial roots of birch, alders, etc., in the upper layers of a bog are not so prejudicial, as they are generally rotten and can be severed with a spade.

Machines have recently been constructed, to replace manual labour in cutting turves; one invented by Browowsky † is used in North Germany, and cuts turves 3 to 6 yards long and $2\frac{1}{2} \times 2\frac{3}{4}$ feet in section, even from undrained bogs. These large turves are then cut into smaller sizes by manual labour.

(c) *Drying the Turves.*

As much care should be taken in drying as in digging turves, for their value as fuel depends greatly on the thoroughness with which they are dried. The air dries the interior of

* In the Landstuhl bog, near Kaiserslautern, there are three layers of Scots pine-stumps separated by peat, that yield annually 28,000 cubic feet of stump-wood. They are converted into tar.

† Hausding. "Indust. Torfgewinnung," p. 25.

turves better than solar heat, which quickly hardens their surface but leaves them still wet internally. Turves may be dried either out of doors, or under cover.

i. *Drying Turves out of Doors.*

The drying-ground is either on the bog itself, or on an adjoining plot when the latter is too wet; as already stated, it should be prepared before digging the peat. The turves are stacked in various ways, according to the space available for

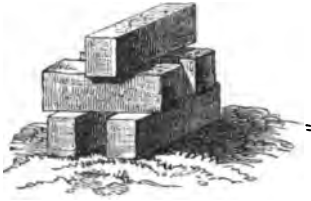

Fig. 394.



Fig. 395.

Methods of piling turves.

drying them, their comparative wetness and rate of drying, and the available labour-force; in order to dry them properly, however, they should always be turned over several times.

As soon as they are cut, the turves are removed usually by the workmen, either in wheelbarrows, or by the men forming a chain and passing them from hand to hand. They are then placed singly and on their edge, like bricks, at short intervals, or piled in little stacks of five turves each (Fig. 394); or as in Fig. 395 round a stake, up to a height of 8 to 4½ feet, a method usual in Swabia and around Lake Constance; or, as in some parts of Austria, stakes are driven into the ground with 9 or 10 pointed transverse sticks attached crosswise to their ends, on which the turves are impaled. After a preliminary drying, the turves are turned over once or several

times, the lowest ones being brought to the top of the stack, and *vice versa*.

As explained already, when space is limited, the turves are dried first on the top of the bank of peat, which is cut in alternate strips. It is evident that the turves when stacked for drying do not dry so quickly or thoroughly as when placed singly on the ground. The lower turves must therefore be further dried on the drying-ground, and for this purpose may be placed in circular rings of 5 or 6 turves on the ground, over which 4, 6 or 8 rings are placed, the space between two turves in a lower ring being covered by a turf in the ring above it.

When the turves are dried thoroughly—for which 4, 6 or 10 weeks are required, according to the weather, mode of drying and quality of the peat—if they are to be at once sold and removed, they are piled in the usual rectangular or conical sale-stacks, each containing 1,000 turves, or else in stacks similar to those used for firewood.

ii. *Drying under Cover.*

Sheds for drying turves are similar to those used for bricks, being very long and narrow and formed of laths, which are covered with a light roof, and in which the turves are stacked one above the other. These sheds offer the great advantage that the drying process is independent of the weather, but they are too expensive for general use.

Drying, however, is conducted in sheds, much more rapidly and thoroughly than in the open air, observations at Waidmoos having shown, that in four weeks, turves thus dried lost about 20 per cent. more moisture than in the open.

iii. *Shrinkage.*

From 70 to 90 per cent. of the weight of freshly-cut turves is water; most of this is lost in drying, but air-dried turves still contain 26 to 30 per cent. of water. In passing to the air-dried condition, turves shrink considerably, the more so the better their quality.

Some peats lose 70 to 75 per cent. of their volume by

shrinkage, so that a volume of 100 cubic feet of wet peat becomes only 25 to 30 cubic feet when dried. Fibrous peat, on the other hand, does not shrink much, but loses much more in weight than good peat, weighing frequently only one-fifth, or even less, of its weight when freshly cut.

(d) **Storage of Turves.**—The turves cannot always be sold and removed at once, but sometimes must be stored through the winter. This is done either in the open, or in covered stacks.

The cheapest method is to pile the turves in stacks, either conical or prismatic, and sloping at the top. Turves which are not thoroughly dried, may, however, be spoiled in this way. The stacks should be erected in a dry and somewhat elevated place and piled carefully.

The turves are protected from damage much better when the stacks are thatched. Straw, reeds, spruce-branches or bracken will serve the purpose; better still, a light plank roof supported by four posts may be erected with a slope towards the rainy quarter, or the turves may be placed as follows—in the centre of a cleared space a strong stake is driven vertically into the ground, and billets placed radiating in a circle from the stake (as in the base of an Alpine charcoal-kiln) and covered with planks; the turves are then piled on this floor in a truncated cone thatched with straw. From these thatched stacks the turves can be taken during winter according to requirements, this can be done from uncovered stacks only at the risk of spoiling them.

Whenever the value of turves is sufficiently high, it is best to store them in sheds, which should have their greatest length perpendicular to the direction of the prevalent wind, and be lightly built of planks or laths, so that the wind may blow through them, the rain being kept out by a roof.

2. *Moulded Peat.*

Some peat is not sufficiently compact to be cut into turves, but must be moulded. This is the case with bogs containing much imbedded wood, or so dry that the peat crumbles into dust, or so wet that the peat must be dredged; also where the peat is only ordinarily moist, but cannot be cut into turves

owing to the presence of numerous undecomposed roots. In ordinary peat-bogs, however, where turves are cut, there is always a large percentage of waste peat resulting from the digging, drying or transport of the turves, which can be utilized only by moulding it. This waste frequently amounts to a fifth or a quarter of the annual yield of peat, so that some turf should be moulded in every moor, and not only where all the peat is moulded.

The different works in question are—**preparing the peat, and moulding and drying the turves.**

(a) **Preparing the Peat.**—Peat which is to be moulded should form a homogeneous mass, containing a suitable amount of water, and capable of being kneaded. If the peat is naturally powdery and dry, it should be mixed with water in a pit, or in a wooden bin with holes in its base; if it is muddy peat with a superfluity of water, it must be dredged out of the bog with a hollow shovel or in a purse-net, and poured into the bin or on straw laid on the ground, so that the superfluous water may drain away. In whatever way it is collected, the mixed peat and water must now be thoroughly kneaded and worked together until they form a fairly homogeneous mass. This is generally done by men trampling on it with bare feet or with flat clogs, less frequently with the help of hoe or spade.

When the peat is of the ordinary consistency and moisture, the workmen place planks in the trench in front of the bank of peat, and cut the peat away from the bank with a sharp cutting mattock, letting it fall on the planks, and watering it sufficiently by means of wooden buckets. In Holland and several places in North Germany (especially Hanover), the peat-pulp is left alone to dry for a few days, and then again kneaded. In South Germany, it is moulded while still very wet, the second operation being omitted.

(b) **Moulding the Turves.**—The turves should be moulded at a place close to where the peat has been dried. If this is at any great distance from the bank of peat, the peat-pulp is removed in baskets or bins which are placed on wheelbarrows; it is then thrown on to straw or planks, and is either cut or moulded into shape, the moulds containing several compartments or being similar to those used for brickmaking.

Peat-pulp is cut into shape in Holland, Friesland or Hanover, being spread out in layers, often half an acre in extent, and beaten flat with flat wooden shoes, planks or shovels. The pulp is allowed to lie for several days, and when sufficiently dry and consolidated it is cut with sabre-like blades, or sharp spades, in parallel strips as broad as the turves are long. After a few more days' exposure, these strips are cut into turves.

When on account of its watery condition, the peat-pulp is collected in perforated bins, in which it is worked up, it is moulded into turves by means of wooden frames without bases; these are placed on the ground or on a bench, and the pulp poured into them. Its surface is levelled by means of a board which is also pressed down on the pulp in the frame to expel the water.

Moulds of several compartments are composed of rectangular wooden frames open above and below, and divided into 16, 28, 36 or more compartments, each the size of a turf. A mould is then placed on a bench, or on a substratum of straw, reeds, etc.; the peat-pulp is poured into its compartments with a shovel, pressed down, and the mould is then removed. In order that the turves may not stick to the sides of the compartments, they are lined with tin, or their bases are somewhat wider than their tops.

Simple moulds resembling those used in brickmaking are used by a workman standing before a bench, often made of cast-iron, on which the mould is placed. The mould is of wood, open at top and base, its interior the size of a turf and generally lined with tin. The workman from a heap of peat-pulp on his bench, takes sufficient with both hands to fill the mould, strikes off the superfluous peat with a board, the size of the base of the mould; he then places the board over the mould, turns the latter over, raises it and leaves the turf resting on the board. A second workman takes the board and turf to the drying-ground, and brings back the board. In the meantime the former workman continues to make turves with the mould and other boards.

Experience shows that a simple mould is at least as expeditious as a multiple one, a man, with a boy to remove the

turves, preparing 1,000 to 1,500 turves in a day. As, moreover, the peat-pulp passes again through the workman's hand, and all foreign matter can thus be removed, the turves in that case are more uniform and free from extraneous matter, and as the peat is not poured but pressed into the mould, the turves are denser than in the former method.

(c) **Drying Moulded Turves.**—Moulded turves must be dried more gradually and carefully than those that are cut directly from the bog. When peat-pulp is cut, the turves are left to dry for a few days, and then turned on to their narrow sides; then they are piled generally in superposed rings (as described above, p. 808). They must be turned again once or twice, according to the state of the weather and are stacked when completely dried. Moulded turves generally dry more quickly than cut turves, especially when they are moulded like bricks and dried like ordinary turves.

When the peat is very watery and moulds of several compartments used, it is better, after the preliminary drying on the ground (which is not required for brick-moulded turves) to place the turves under cover, as they cannot withstand prolonged rain. Turves made in multiple moulds may be destroyed entirely by rain, so that this method can be adopted only in fine weather.

(d) **Quality.**—Moulded turves afford a better fuel generally than cut turves, in ratios of 5 : 3 or 5 : 4. This is due to their greater homogeneity, the removal of extraneous matter, greater density and the use of amorphous peat, which is often wasted when the turves are cut from the bog.

3. *Manufactured Peat.**

Manufactured peat is so prepared as to be capable of competing with other fuels in the market.

Turves cut from bogs or moulded by hand will not bear distant transport, firstly, on account of their large volume compared with their value as fuel, and secondly, on account of their brittleness and property of absorbing much moisture

* An interesting account of peat manufactured at Schussenried in Wurtemberg, is given in "Baur's Centralblatt," 1881, p. 88.

in damp air and of falling to pieces when frozen. These turves are, therefore, saleable only in the immediate neighbourhood of the bog; the price obtained for them, being low, does not encourage an extensive working of the bog. Owing to the high price of fuel which prevailed a few decades ago, the large demands for industrial purposes and the extensive supplies of peat available in certain districts, the question arose as to whether peat might not be so improved by machinery as to yield a fuel approaching coal in value. Owing to the subsequent depression in the price of fuel, the demand for manufactured peat has somewhat abated, but the industry is still carried on in many places.

In order that manufactured peat may compete with coal and wood, it must be utilizable for heating boilers, preparing gas and paraffin, in metallurgy, etc., and should fulfil the following conditions:—

Density.—The turves must not merely be dense superficially, nor so dense at the surface that the air cannot reach their interior, but be uniformly dense throughout.

Compactness.—The turves must be compact enough not only to retain their shape during transport, but also while being burned.

High combustible power.—During manufacture, the most combustible parts of the peat must be carefully preserved, especially the amorphous peat.

Dryness.—The peat must be dried thoroughly, not only superficially, but also internally; it should, as far as possible, lose its great hygroscopicity and not swell considerably when exposed to damp and thus become unserviceable.

Quantity.—The manufacture must be so conducted as to yield large quantities of material and be independent of the weather.

The cost of production, including that of supervision, must be sufficiently low to allow the material to compete with other combustibles.

The following methods have been undertaken to secure the above conditions:—contraction, dry pressure, wet pressure and destruction of structure, with or without pressure.

All these methods are, however, too costly to repay the

expense unless the price of fuel is as high as during the 'forties of this century. Several of these methods have fallen into disuse, whilst others have been adopted. The former will, therefore, only be shortly considered, more attention being given to those still in vogue.

(a) **Contraction.**—Challeton at Paris, and Ray at Neuchatel adopted the following method of increasing the density of peat. The turves were cut from a bog, brought to the factory and then cut to pieces by a system of rollers with blades fixed on them; the material was then treated with running water so as to form a thin pulp, which ran over fine sieves in order to remove all coarse fibres. This fine pulp is then led in canals to a trench one to two feet deep, the bottom of which is covered with reeds or rushes. In this trench the pulp sets firmly, the water draining off through the reeds, and after a few days it can be cut into turves by means of a wooden lattice-frame as broad as the trench, which is pressed down on the peat.

The specific weight of Challeton's peat, according to Schenk, 1.1 to 1.2, and to Dullo 1.8, is equal to that of coal. But it is not suitable for fuel, as it burns like charcoal, without any flame, the turves also fall to pieces in the fire and block up the grate.

(b) **Dry pressure.**—In this case the peat is subdivided as finely as possible, thoroughly dried and pressed into turves. The experiments of Exter made a few years ago at Haspelmoor, near Munich, and some other places, give the best known results of this method. The bog was superficially ploughed by a steam-plough. All the refuse peat was finely subdivided, dried and conveyed to the factory. It was then sifted and thoroughly dried in a specially designed hot-air chamber, which it left with only 10 per cent. of moisture, and was then converted into turves by a powerful press.

This product, however, did not answer the purpose intended, as it fell into dust while burning, and was scarcely superior, as fuel, to the best ordinary turves.

(c) **Wet pressure.**—Owing to the obvious advantage resulting from pressing the wet peat, and thus increasing its density, and at the same time its compactness, more attempts have

been made in this direction than in any other. No attempt, however, to press raw peat has succeeded, partly on account of the fibrous nature of the peat, which caused it to swell again after the pressure had been removed, and partly because the valuable humus-carbon escaped with the water, and thus the product deteriorated as a combustible. Other kinds of pressed turves were too dense externally, and their interior either did not burn well or else retained too much moisture.

(d) **Destruction of the Structure of the Peat, with or without Pressure.**—It is now everywhere recognised that the structure of the peat must be destroyed before the turves are formed, and that, only a moderate pressure, if any at all, is advisable. The apparatus of Schlickeysen and Geysser, Gratjahn and Pelau, Mecke and Sander, Weber and Maffei, are those best known for this method.

(i.) **Method of Schlickeysen* and Geysser.**—A vertical axle is moveable by steam-power in a vertical, hollow, cast-iron vessel, with a funnel-shaped top. On the axle are six sharp horizontal knives, fitted to it like the thread of a screw, while six corresponding knives are on the walls of the vessel. There is also a moveable base, which is attached to the axle and rests on the real base of the vessel, and immediately above it are two holes on opposite sides of the vessel through which the prepared peat passes. The peat placed in the vessel while the axle is in motion is cut into shreds by the knives, which also cut through all pieces of roots; it is at the same time pressed slightly downwards by their screw-like action, and finally passes out through the holes in a round rope-like mass of stiff paste. This runs out continually on to a bench, and is cut into pieces and dried.

Although no water is added to that originally in the peat, the latter is quite plastic. The fresh turves are moderately dense; though covered superficially with a smooth gelatinous coating they are yet capable of being dried easily and thoroughly. There is no loss of humous-carbon, which during the macerating process becomes attached to the walls of the vessel and issues from it as a glazed coating to the turf. In twelve hours, 15,000 turves, each a foot long, can be cut from

* Leo, "Die Kompression des Torfes."

each side of the vessel, and in favourable weather they dry rapidly with a considerable shrinkage. This turf can be used not only as ordinary fuel, but also in the manufacture of glass and porcelain, it must then be dried in kilns. *Gysser* has invented hand-machines of a similar description to the above, as represented in Figs. 396 and 397, and capable of turning out 2,500 to 3,000 turves in a day. These hand-machines have the advantage over that of *Schlickeysen*, of saving the transport of the wet peat, besides saving fuel, and can be



Fig. 396.—Gysser's machine for pressing peat.



Fig. 397.—Section of Fig. 396.

worked on the bog; at the same time, they are not applicable in the case of very fibrous peat, or where there are many roots. *Gysser* dried the peat in an excellent manner in portable drying sheds, consisting of frames like hurdles placed one above the other, and covered with a roof.

(ii.) **Method of Grotjahn-Peau.**—Figs. 398 and 399 show the machinery constructed by G. Krauss & Co., of Munich.

The elevator *a b* (Fig. 398) raises the irregularly shaped pieces of peat to *b*, where they fall into a bin *c*, and hence into the horizontal macerating machine, the interior of which is shown in Fig. 399. This is of somewhat similar construction to *Schlickeysen's* vessel containing a moveable axle with

revolving knives. The peat is thus finely subdivided, uniformly mixed together, and finally issues through the orifice *b*

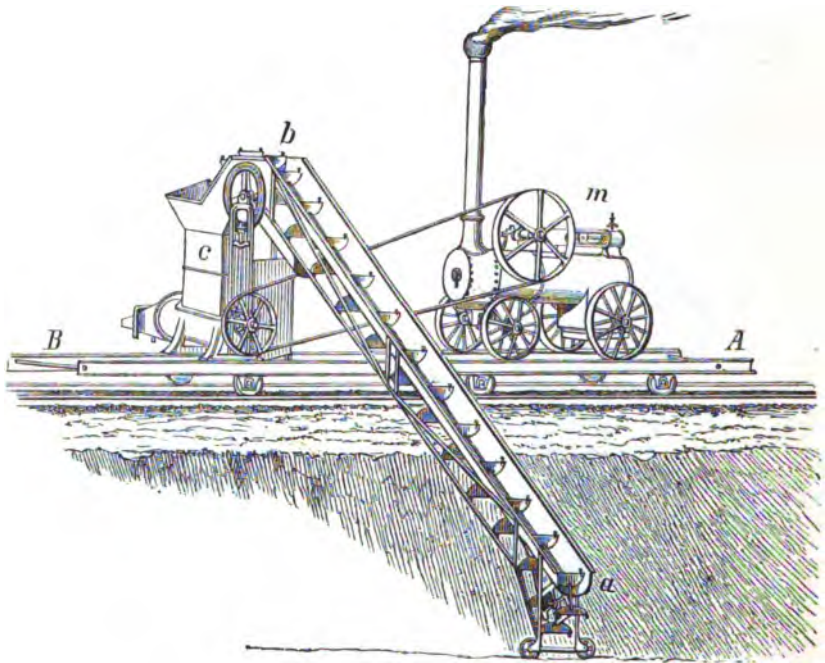

Fig. 398.—Grotjahn's machine.

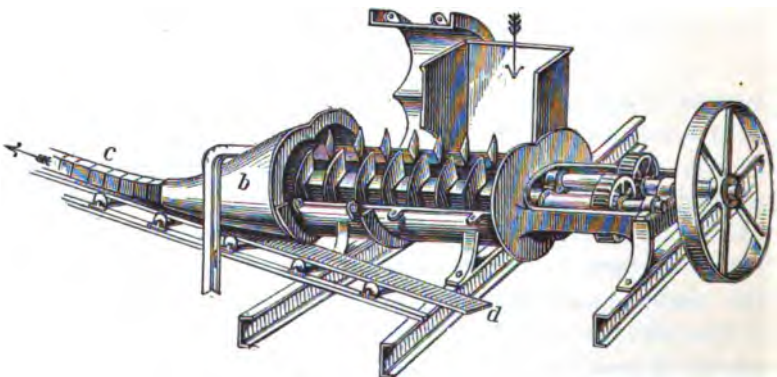

Fig. 399.—Cutting cylinder of Grotjahn's machine.

(Fig. 399), on to a plank *d c*, which is pushed forward on rollers. A workman stands at the orifice of the machine and cuts the

issuing part into turves with a sharp instrument. The elevator and macerating cylinder are driven by a locomobile *m*, and they both stand on a frame *A B*, which can be moved by means of small wheels along a tramway as the digging-ground advances. The plank *d* is taken with the turves on it to the drying-ground, and turned over carefully, and then brought back to the machine. This mode of preparing turves has been employed extensively, both in North and South Germany.

(iii.) Mecke and Sanders, of Oldenburg, have constructed a machine consisting of a long steel girder (30 metres) *A B*

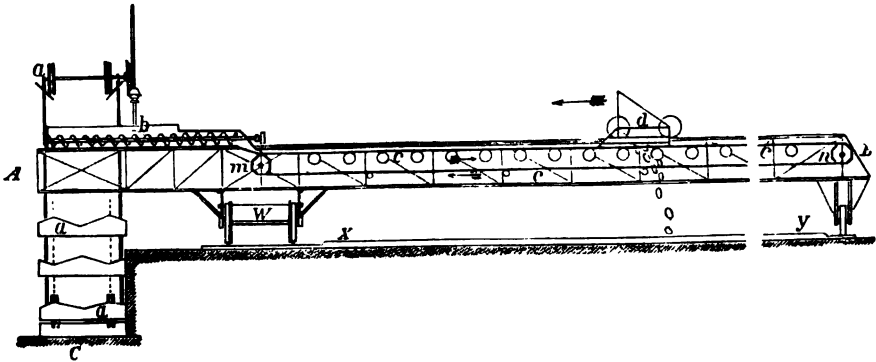

Fig. 400.—Mecke and Sanders' machine.

(Fig. 400) resting on a car *W* and a wheel *y* which run on rails or boards parallel to the peat-cutting *C*, and placed at a proper distance from it. *a a* is the machine for cutting the peat, and can be placed higher or lower, according to the depth of the cutting. It is self-regulating to avoid impediments in the peat, roots, etc., and cuts the peat with the saw teeth of a dredger, in thin vertical strips. The turf is elevated by an endless chain, attached to the dredging sections, into the mixing apparatus *b*. The latter is an iron cylinder containing two rotating axles provided with a projecting screw, which mix up uniformly all the turf coming from different depths and press the homogeneous peaty paste through a wide opening on to the distributing apparatus *c c c*. The distributing apparatus consists of a chain stretched over two rollers, *m n*,

and bearing successive flat pieces of wood, 20 inches long and 6 inches broad, through which passes a slowly moving flat chain supported by rollers. This chain takes up the peat-paste, and a car (*d*), like a snow-plough, throws it down uniformly on to the drying platform *xy*. The drying platform is made of sods of grass well-levelled and serves as a filter by absorbing the water from the paste, so that the latter dries rapidly (even in rainy weather in 24 hours). The paste is pressed flat by the workmen with planks on their feet, and cut up into turves.

The machinery is driven by steam-power, and 100,000 turves are prepared daily on a peat-moor at Oldenburg. Rain is no impediment.

(iv.) The **Weber-Mattei** method is employed at Staltach in South Bavaria. This long-approved method macerates the peat, mixes it uniformly, but forms it into turves by hand. The peat dug from the moor is conveyed to the factory in waggons. It is then raised by elevators on to a platform and thrown into the macerating machine, which is an improvement on Schlickeyesen's machine. At Staltach, it consists of four long buildings forming a square, three of which are the air-drying sheds and the fourth a hot-drying shed. The air-drying shed is made of posts supporting a strong roof and provided with a succession of horizontal trays 18 inches apart. A tramway passes through the middle of the sheds, by which the peat paste is brought in. The workman places a plank on the lowest tray, presses on it a mould of 7 cells, kneads in the paste, lifts up the mould and places it close to the 7 turves, and continues to make turves till the first plank is covered with them. Then he proceeds in a similar way with the next tray, and so on till the shed is full. After the turves have remained 3 or 4 days under cover they acquire a consistency like leather, but are still porous enough to part with their interior moisture. They are turned over, placed on their ends and dried gradually till they contain only 25 per cent. of water, being then suitable for fuel. If they are to be charred, the air-dried turves are placed for some time in the hot drying-shed and lose another 15 per cent. of water.

(v.) **Eichorn's Method** differs from the preceding ones,

and is employed at Aibling, near Rosenheim; the product is in balls. The macerated peat is mixed gradually by a horizontal cylinder with an archimidean screw. The balls of peat descend by a slide to the drying-chamber, which contains a number of heated tubes, down which the balls descend on spirals.

Some progress has certainly been made in the quality of machine-made turf. Hausding* states that, air-dried machine-turf, with at most 10 per cent. of ash, has $\frac{2}{3}$ rds the heating power of superior coal, so that one cwt. of machine-turf is equivalent to $\frac{1}{2}$ to $\frac{2}{3}$ cwt. of coal, whilst ordinary turves are equivalent to only $\frac{1}{3}$ to $\frac{1}{2}$ cwt. of coal.

It may here be noted that several attempts also have been made to carbonise peat and produce peat-charcoal in order to increase its market value as a fuel.

4. Peat-Litter.†

Peat is not used for many other purposes besides fuel. Its use, however, for stable litter is increasing in importance, and is especially noticeable here, as there is a hope that by this means the disastrous use of forest litter may be stopped.

Peat forms a much better stable litter than either forest litter or straw, for it is 3 to 5 times as absorptive of fluids as the latter, and thus prevents any waste of animal manure, either in the form of urine or ammonia. The humic acid in peat also acts beneficially on the salts, alkalis and alkaline earths of the soil. Peat also improves the soil physically more than other litter, retaining moisture in loose soil, loosening binding soil and especially in promoting porosity. Its capacity for

* *Op. cit.*, p. 720.

† Vide Dr. Fürst, "Die Torfstreu," 1892; also Bavarian "Torfstreu und Mullwerk," Haspelmoor. Mendle, "Die Torfstreu," 1882.

‡ According to experiments made by Wollny, Classen and Petermann, the following are the absorptive capacities of different substances.

| | Percentage of Weight. | | Percentage of Weight. |
|------------------------|-----------------------|------------------------|-----------------------|
| Spruce-needles ... | 161 | Moss | 409 |
| Scots pine needles ... | 207 | Spruce saw-dust ... | 440 |
| Oak dead leaves ... | 242 | Haspelmoor peat-litter | 636 |
| Beech " " ... | 257 | Oldenburg peat ... | 659 |
| Wood-wool ... | 285 to 440 | Haspelmoor prepared | |
| Rye straw ... | 304 | peat-meal | 690 |

heating the soil has been shown clearly in vineyards. The air in stables in which peat-litter is used is free from ammonia and is thus made healthy; the beasts have a dry, soft bedding, the litter is also preferable to other kinds for horses, cattle, sheep, pigs or poultry. Peat also is used in the dry-earth closet system. Only loose-textured, mossy or fibrous peat, forming the superficial layer of bogs, is used for litter. In some bogs layers of the fibrous peat and amorphous black peat alternate; preparation of peat for fuel and litter should then proceed

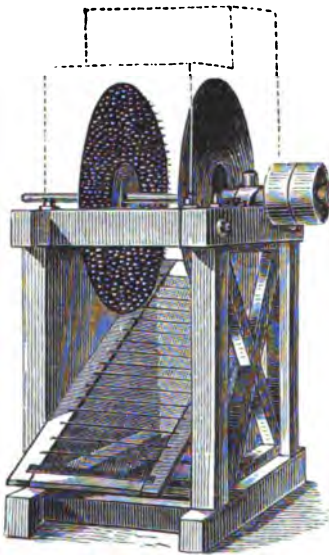

Fig. 401.—Mill for tearing up peat.

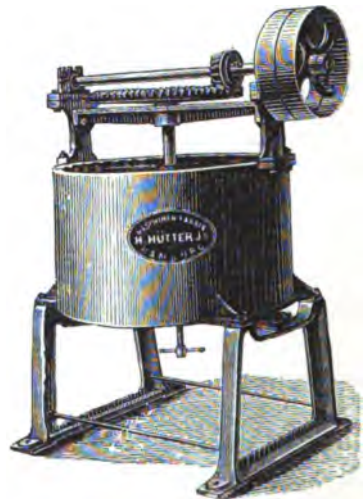

Fig. 402.—Mill for preparing peat-litter.

simultaneously. The peat should be dried and then finely subdivided in a peat-mill (Fig. 401) and pressed into a rectangular bales weighing 2 to 3 cwt. each. [Such bales of peat-litter are now imported largely from Holland into London, for omnibus and tramway stables.—Tr.]

Machines have been constructed for subdividing peat, the commonest of which are represented in Figs. 401, 402, the latter being termed the peat-mill. The subdivided peat falls from the machines on to a wire sieve, which separates the powdery from the fibrous peat. The former is used in dry-earth closets. In

order to preserve the bales during transport, pieces of undivided peat and laths are placed along their edges. About 70 or 80 bales can be carried by an ordinary railway truck.

Peat-charcoal* is prepared by charring peat in retorts, or kilns. This product resembles lignite in heating-power. When prepared at Christiana† by electricity, in retorts, it contains 79 per cent. of carbon.

Dry distillation of peat‡ yields: charcoal 33 to 35 per cent. tar 4 to 5 per cent., tar-water 38 to 42 per cent., gas 25 to 28 per cent.: from the tar, creosote and paraffin are made; from tar-water, methyl-alcohol, ammonium sulphate and acetic acid. Only peat dried to 25 per cent. of water is utilizable.

Artificial wood made of peat is referred to (p. 525). In "Dingler's Polytechnical Journal," 1901, a report is made of briquets of peat with only 1 to 3 per cent. of ash, and as valuable as lignite.

* Müller, "Die Torfverkohlung," 1874. Ekelund, "Die Herstellung komprimierter Kohle aus Brenntorf," 1892.

† "Neue forstliche Blätter," 1902.

‡ 'Bersch, "Die Verwertung des Torfes." "Neue forstliche Blätter," 1902.

CHAPTER V.

LESS IMPORTANT MINOR PRODUCE.

THE most important items of minor produce have been dealt with in the preceding chapters, but there are various other products of the forest soil, which are more or less useful. Most of these are leased by area, either of the whole forest or certain parts of it; permission is given to collect others gratis. Not unfrequently, however, it should first be decided whether utilization will be injurious to the game in the forest, for permission given to persons to wander all over a forest in search of petty products may give rise often to irregularities. The following items of produce will be referred to:—

| | | |
|----------------------|---------------|-----------------|
| Grass-seeds. | Mosses. | Edible Fruits. |
| Herbage for various | Edible Fungi. | Other Products. |
| Industrial Purposes. | | |

1. *Grass-seeds*.*

The frequently abundant growth of grass on clear-cuttings, forest-roads and other places has been described already, nearly all the species of grass occurring that are found in pastures. As meadow-grasses are cut for hay when in full blossom, meadows do not afford grass-seed; but in forests, grasses may be allowed to ripen their fruit and thus afford a useful agricultural product. The collection of grass-seeds is at present in many forests a matter of importance, employs many people and yields a fair revenue.

The species, which, as good meadow-grasses, are chiefly in demand for seed, may be classified as gregarious, light-

* G. Rothe, "Sameln der Grassamen in den Waldungen," Stuttgart, 1875.

demanding or shade-bearing grasses, and are included in the following list :—

Gregarious Grasses.

| | |
|---------------------------|--|
| Fiorin-grass . . . | <i>Agrostis alba</i> , L. : var. |
| | <i>stolonifera</i> , L. |
| „ . . . | <i>Agrostis alba</i> , L. : var. <i>vul-</i> |
| | <i>garis</i> , With. |
| Bent-grass . . . | <i>Agrostis canina</i> , L. |
| Meadow foxtail . . . | <i>Alopecurus pratensis</i> , L. |
| Upright brome . . . | <i>Bromus erectus</i> , Huds. |
| Meadow fescue . . . | <i>Festuca elatior</i> , L. : var. |
| | <i>arundinacea</i> , Schreb. |
| „ . . . | <i>Festuca elatior</i> , L. : var. |
| | <i>pratensis</i> , Huds. |
| „ . . . | <i>Festuca rubra</i> , L. |
| Yorkshire fog . . . | <i>Holcus lanatus</i> , L. |
| Perennial rye-grass . . . | <i>Lolium perenne</i> , L. |
| Italian rye-grass* . . . | „ „ : var. |
| | <i>italicum</i> , A. Br. |
| Meadow poa . . . | <i>Poa pratensis</i> , L. |
| Timothy-grass . . . | <i>Phleum pratense</i> , L. |
| | etc., etc. |

Light-demanding Grasses.

| | |
|--------------------------------|------------------------------------|
| Grey aira . . . | <i>Aira canescens</i> , L. |
| Yellow oat-grass . . . | <i>Avena flavescens</i> , L. |
| Perennial oat-grass . . . | <i>Avena pratensis</i> , L. |
| „ „ . . . | „ „ : var. |
| | <i>pubescens</i> , Huds. |
| Common quake-grass . . . | <i>Briza media</i> , L. |
| Field brome . . . | <i>Bromus arvensis</i> , L. : var. |
| | <i>mollis</i> , L. |
| Crested dog's-tail grass . . . | <i>Cynosurus cristatus</i> , L. |
| | etc., etc. |

* A variety probably raised by cultivation from British grass-seed, but now much imported from the Continent. Bentham & Hooker.

Shade-bearing Grasses.

| | |
|------------------------|-----------------------------------|
| Vernal grass . . . | <i>Anthoxanthum odoratum</i> , L. |
| Tufted aira . . . | <i>Aira cæspitosa</i> , L. |
| Wavy aira . . . | <i>Aira flexuosa</i> , L. |
| Tall brome . . . | <i>Bromus giganteus</i> , L. |
| Sheep's fescue . . . | <i>Festuca ovina</i> , L. |
| Reed fescue . . . | <i>Festuca sylvatica</i> , Vill. |
| Soft holcus . . . | <i>Holcus mollis</i> , L. |
| Spreading milium . . . | <i>Milium effusum</i> , L. |
| Wood poa . . . | <i>Poa nemoralis</i> , L. |
| | etc., etc. |

When the seed is ripe (which for most grasses is in the latter half of June or July, and for others, in August and September) the collectors walk in lines through extensive grassy areas, grasp a handful of spikelets, cut them off and place them in a bag slung in front, which is emptied from time to time on to a large cloth spread out on the nearest road. The spikelets are then put into sacks for removal and again spread out in sunny places to dry, threshed and sifted. The chief points are to collect only one species at a time and avoid entirely seed of bad species; in his own interest the forest-owner should pay attention to this.

The revenue from the collection of grass-seed is sometimes considerable. In the State forests of the Grand Duchy of Hesse the revenues thus obtained in 1873 and 1874 were respectively £634 and £494. This covered from one quarter to one-sixth of the cost of re-stocking the annual felling-areas. In 1878 50 acres of felling-area in the Forest of Stockstadt, near Aschaffenburg, were leased for this purpose in one year for £31. Forstmeister Urich, at Büddingen, sows *Poa nemoralis* in beech felling-areas and on clear-cut areas, in order to produce a crop of valuable grass-seed. The seed of *Milium effusum* (common in Britain) is used as bird-seed.

2. Herbage used for Various Purposes.

Among herbage used for industrial purposes, other than those already described, *Carex brizoides* chiefly deserves mention; it is used instead of horsehair for stuffing furniture, etc. This sedge is found in Germany on the damp, rich, loamy soil of

somewhat open spruce forest, also in coppice and coppice-with-standards of ash, alder, aspen, etc., where it grows in tufts between the overshadowing coppice-shoots and thrives in places sheltered from late frosts. The longer and softer the leaves, the more valuable the product. The sedge is full-grown by the end of June, and may be plucked from then till October; it is dried partially by spreading it on sunny roads, and then brought in and twisted by means of simple machines into plaits. It is collected extensively in the Baden Rhine valley, where 5 cwt. of the grass per acre form a fair crop. The yield may, however, under favourable conditions, amount to 9 or 10 cwt. per acre; 150 pounds of dry sedge yield 125 pounds of plaits, worth 4s. to 6s. per cwt.

In the Grand Duchy of Baden at least 2,000 tons of sedge (worth over £12,500) are collected annually. In 1872, the town of Friburg obtained £1,287 for sedge removed from its forest; and other towns, £712 and £840. In 1873, several communes in Baden obtained 30s. to 60s. per acre for the sedge. More recently the demand has somewhat lessened, owing to the substitution of *Crin d'Afrique* (filaments from a palm, *Chamærops humilis*) as stuffing for furniture, also of cotton from species of *Bombax* (India).

A grass (*Agrostis cæspitosa*) growing in damp forests and usually mature in September, is also used as stuffing material.

A loose, spongy tissue is used under the name of **wood-wool**, that is said to be prepared from pine needles and served as a substitute for cotton and sea-grass. The material sent to Mayr (prepared by boiling in water and weak alkaline solutions) is not made of pine needles, but of sea-grass; for the macerated woody bundles are 10 to 25 c.m. long and woven with very fine cotton-fibres into a soft greenish, or grey loose tissue; the shorter pieces may be fibres from pine-needles.

[The chair-factories at High Wycombe besides horsehair use **Alva**, as stuffing material; * this product is the dried leaves of

* [Communicated by Mr. Glenister, High Wycombe, the plant being identified by Marshall-Ward.

Mr. Isaacs of Mark Lane, states that alva is imported by the ton, in pressed bales, from Holland, France, and Germany, at prices varying from £3 15s. to £9 per ton of 20 bales. It is mowed in the sea, as if dragged out, it is not curly and springy or suitable for stuffing chairs, &c. Also used by florists.—Tr.]

Zostera marina belonging to the Nat. Order *Naiadeæ* and termed grass-wrack by Hooker. It is abundant, at or below low-water mark around the British Isles, on sandy or muddy edges of the sea and is often thrown up in large quantities by the tide.—Tr.]

Rushes are used chiefly as packing-material for bottles of superior wine, and for the seats of chairs. Share-grass (*Equisetum*) is used for polishing furniture, and is largely exported from Germany, to Greece, Turkey, and Hungary.

2. Mosses.

Polytrichum commune, a moss often growing a foot high in wet places, is used for making brushes that are fashionable in France, the material chiefly coming from Germany. The moss is cut in the forest, tied in thin bundles and steeped like flax; it is rolled on ribbed planks, again heated to render it pliable, and is then ready for use for weavers'-brushes, scrubbing-brushes, carpet-brushes, etc. The roots of the common crowberry (*Empetrum nigrum*. L.) and of *Polytrichum commune* and *P. urnigerum* also are used for brushes, velvet brushes being made from the latter in Rhenish Prussia.

Tamarisk-moss (*Hypnum tamariscinum*) is largely used in the manufacture of artificial flowers, *Hypnum splendens* being less valuable. Tamarisk-moss is found chiefly in beech forests, and the other moss among conifers; they are collected in summer, kept dry under cover, and during winter the separate fronds are cleaned, pressed between leaves of paper, sorted, dyed and packed.* Sphagnum-moss also is used for the transport of living plants. Mosses are gathered by hand, with or without permits.

3. Edible Fungi.

The truffle (*Tuber melanosporum*) is the most valuable of edible fungi; it is found chiefly in oak, hornbeam, hazel, beech and ash forests, its mycelium being parasitic on the roots of the trees, a few centimeters underground, in damp, rich, calcareous soils of the warmer parts of France and Germany.

* "Dankelmann's Zeitschrift," iv., p. 159.

[Formerly it was fairly common in oak forests in the South of England, and is still found in Sussex and Hampshire, and should be grown extensively in the south-west of Ireland.—Tr.] Other species of truffles, especially *T. brumatum* (*æstivum*) and *T. excaratum*, etc., are less valuable. The importance of truffles may be gathered from the fact that 1,500 tons (worth £640,000) are exported annually from France; in the whole of Germany only about a ton (worth £350) is collected yearly.

[In the forest of Bedoen, on Mount Ventoux, truffles grow extensively on the roots of *Quercus pubescens*, their sale having produced £1,500 in 1897, the rate being 3s. to 9s. per lb.

In Perigord, land formerly stocked with vineyards is now planted with young oaks for the cultivation of truffles, which grow as a *mycorrhiza* on the oak roots. This is said to pay three to five times as well as vineyards. Whole villages are engaged in this industry, which has now gone beyond the experimental stage. The following recipe for their cultivation is given by de Lesparre in the *Rev. des E. et F.*, 18th September, 1898. Take a truffle and dry it thoroughly (in a drawer). When quite dry, it should be bruised into a pulpy paste with water between two pieces of ground glass. This paste should be spread with a paint brush, between July and January, on green leaves of the hazel or oak, which should then be placed in the ground. Eight or nine days later the spores germinate, and the mycelium of the truffle is produced. The soil should be calcareous and the climate suitable for the vine. In 5 or 6 years truffles will be produced and must be under the shade of trees.—Tr.]

Among other edible forest fungi, *Boletus edulis*, *Morchella* sp. sp., *Clavaria*, *Hydnum* and *Cantharellus* may be cited. The common mushroom (*Agaricus deliciosus*) grows rather in meadows than in forests.

4. Edible Fruits.

Cranberries and bilberries are the edible fruits most frequently collected from forests. In many districts all the children are engaged during the season in collecting these berries, and a large trade is driven in the produce; there are commercial houses in North Germany which deal with them

to the extent of £5,000 and more yearly. The forests of the Fichtelgebirge, the Spessart, the Schwarzwald, etc., yield large quantities of these berries. When fully ripe, large wooden combs are used to strip off the berries into baskets. Only a small part of the produce is now used for brandy; it is chiefly made into wine, partly to convert white wine into red wine and partly as bilberry wine, which is sold at Frankfort-on-Maine and other places as a medicinal beverage; it has also been sent in large quantities to the south of France to be mixed with grape-wine and sold as claret.* Bilberries may be also eaten fresh, cooked or dried.

It is well known what enormous quantities of wild strawberries, raspberries, alderberries, etc., are gathered annually. In the village of Frammersbach, in the Spessart, children yearly collect these berries to the value of £200.

Mistletoe-berries are here and there collected for making bird-lime. [Branches of mistletoe for Christmas form a yearly article of trade from Normandy to London, whole steamer-loads arriving from the Norman apple-orchards.—Tr.]

10. Other Items.

Among the multifarious forest plants, which are used industrially or medicinally, may be mentioned:—Willow blossom, for apiculture; orchid-bulbs, as *salep*; spores of *Equisetum clavatum*, for artificial lightning: roots of valerian and berberry (*Berberis vulgaris*) and flowers and fruits of a number of shrubs and herbs, *Arnica*, *Atropa*, *Colchicum*, etc., for medicine.

The beetle Spanish-fly (*Lytta vesicatoria*) also is collected for sale in Hungary.

[The items of minor forest produce exported from the Indian Forests, such as medicinal drugs, dyes, paper material (Bhābar-grass—*Ischæmum angustifolium*—*Daphne papyracea*, bamboo, etc.), textile fibres, lac, wild-silk, honey and wax, besides those already mentioned in former chapters of the present book, are far too numerous to be described here. Reference on the subject is invited to Watts' Dictionary of Indian Economic products, and Troup's Forest Utilization.—Tr.]

* E. Laxis, in "Handelsblatt für Walderzeugnisse," 1894, No. 23.

PART IV.

UTILIZATION OF COMPONENTS OF THE FOREST SOIL.

UTILIZATION OF STONE, GRAVEL, ETC.

In mountain-forests, the utilization of stone is frequently an important item of forest revenue ; quarrying the better kinds of stone increases in importance with the expansion of towns, the more substantial nature of the buildings erected, and the constantly extending means of communication. Independently of the fact that an absolutely necessary want is thus met, the forest-owner's own pecuniary interest will prevent him from opposing a well-regulated system of quarrying, for the best production of wood will never pay so well as leasing quarries.

1. *Different kinds of Stone.*

The following kinds of stone are utilized :—**Hewn-stone**, which is cut into regular shapes, and for which the fine, compact sandstones of the Cambrian, Silurian, New Red Sandstone and Tertiary formations, also trachyte among eruptive rocks, etc., are most in demand. [In Britain, also Bath oolite, Aberdeen granite, etc.—Tr.]

Broken stone used in **rubble-masonry**, for foundations, etc., for which almost any kind of stone is suitable ;—or **paving stones**, for which the hardest material, basalt, phonolith, diorite, fine-grained syenite, etc., are most suitable. **Slate** for roofing from the Cambrian, Silurian and Jurassic (Stonefield slate) formations, and **lignite** near Liegnitz and Frankfort, are also valuable. Large quantities of the harder rocks, as well as boulders and gravel, are used for macadamised and paved roads. Calcareous rocks are also of great importance, serving as building-stone or for lime-burning, for which purpose they are the more valuable the less clay they contain ; when mixed

with clay they are used for cement. Quarries of gypsum, felspar and kaolin are rare.

2. *Mode of Utilization.*

Stone is obtained either by quarrying the mountain-side, in deep quarries, or by collecting boulders or flint-nodules from the surface of the ground. From a silvicultural point of view, permanent quarries are greatly preferable to the employment of boulders, as the area taken from the production of wood is then of limited extent and more easily controlled: the growth of wood being permanently excluded from the area, no question of indirect injury to the forest can arise. Direct injury to the forest may, however, occur in quarrying—in the experimental search for suitable localities for a quarry; the loss of wood production on areas which are often extensive; the damage to roads, and occasionally the increase in forest offences owing to the presence of the quarry-men in the forest.

The quality of stone from the same geological formation may vary considerably in different parts of the same mountain-side; hence several experimental quarries are frequently commenced and eventually abandoned. This causes loss of a considerable area for wood-production, as when the soil is covered with fresh unweathered rock it is often impossible to restock it with trees. Even when a workable quarry has been started, often fairly large areas are required for deposit of the refuse stone, and on steep slopes the latter often accumulates in long strips down the valleys, as in the Siebengebirge.

This nuisance may, however, be improved by good regulations and confined within reasonable limits. It is therefore indispensable that not only the quarry itself, but the area on which refuse may be thrown should be demarcated carefully. Forest offences by quarry-men, who are sometimes imperfectly acquainted with the limits of mine and thine, cannot be avoided altogether. Considerable damage also is done to the forest roads, no traffic being more ruinous to them than that of stones from quarries. The latter are not usually important enough to warrant the construction of roads specially made for them alone; hence the nearest forest road is used,

and if the expense of its maintenance falls exclusively on the forest-owner, this may cost him more than he obtains from the stone-quarry. In such cases a condition should be entered in the lease of the quarry for payment by the lessee for maintaining the road in good condition.

Although regular quarries are usually more profitable than the mere collection of boulders, the latter are often harder and drier than freshly quarried stone from the damp mountain-side, and are, therefore, much used for rough building purposes, if the slope on which they are lying is steep enough to facilitate their collection, and roads are available for their removal from the forest.

As in this case, the stones are collected from among trees, damage to the standing-crop is always to be feared, and especially to the roots of the trees. It is the interest of the lessee, however, to be careful, as he would otherwise lose the business, so that the best precautions against damage are usually taken.

[Considerable damage is done to the roots of trees in the forests of Normandy, by removal of superficial flint-nodules. It should also be noted that large stones lying in regeneration areas often preserve moisture in the soil, and therefore their removal should be restricted to older woods, in which the cover has not been interrupted.—Tr.]

The forest-owner rarely undertakes the quarrying or removal of stones at his own expense; even if he should require the stones for buildings, walls, or road-metalling, it is better to obtain them by contract, rather than by daily labour. Hence it is usual to lease quarries.

As regards the components of weathered forest soil and substrata, humus and vegetable-mould, for gardens and forest-nurseries; sand and gravel, for roads and buildings; clay for harbour-works and for bricks and tiles; kaolin for porcelain, are the chief items.

[In the north of India, considerable revenues are obtained by leasing the limestone-boulders in the beds of watercourses, which are dry for 8 months in the year; lime-burning has the further advantage of causing a large demand for firewood, for which it is often difficult otherwise to find a market.—Tr.]



INDEX.



A.

Abnormal structure of wood, 124
Absorption of water by wood, 66
Advertising sales of wood, 479
Alburnum, 44
Alderwood, 29
Anatomy of wood, 7
Anobium sp., 108
Antiseptic treatment of wood, 509
Artificial wood, 524
Ashwood, 22
Assortments of timber, 238
Auctions of timber, 455
Autumn-wood, 66
Axes, 175

B

Balata, 788
Balks, 558
Bamboos, 17, 43, 555
Bandboxes, 682
Band-saws, 496
Bark, anatomies of, 629
 ,, other uses besides tanning,
 662
 ,, for tanning, 688
Barrels, 599
Bast, lime, 662
Battens, 561
Bean-sticks, 614
Beech-nut oil, 698
Beechwood, 21, 587
Bentwood for furniture, 507
Betulin, 83, 110
Bilberries, collection of, 829
Bilberry bushes for litter, 778

Billhook, 180
Birch-bark, 661
Birch oil, 662
Birchwood, 80
Birdseye maple, 181
Blasting stumps and roots, 248
Bleaching wood, 115, 508
Boards, 560
Boat-building, 577
Bogs, 790
Bole, cleanness of, 119
Booms in timber floating, 380
Boucherie, 512
Boxwood, 84
Bracken, 777
Branches for litter, 777
Briar-wood for pipes, 624
Bridges, timber for, 574
Brooms, 609-616
Brushbacks, 609
Brushwood, 238, 261
Burs, 182
Butchers' blocks, 598
Butts, 237, 259

C.

Cabinet-making, 586
Camphor, 728
Canals, influence on timber-trans-
port, 427
Caoutchouc, 781
Carbonisation of wood, 698
Carriage-poles, 592
Cart traffic, 818
Casks, 594
Cedrela wood, 569

- Celluloid, 564
 Cellulose, 79, 551, 662
 Cembran pine-wood, 89
 Charcoal, 116, 527
 Chemical properties of wood, 79, 154
 Cherrywood, 28
 Chestnut wood, 25
 Children's toys, 610
 Christmas trees, 619
 Chutes, timber, 278
 Cigarboxes, 589
 Circular saws, 495
 Cleanness of bole, 119
 Clearing felling-area, 262
 Cleaving-axe, 197
 Cloven timber, 561
 Coherence of wood, 65
 Colour of wood, 48
 Compass timber, 581
 Conductivity of wood, 78
 Cones, collection of, 672
 Coniferous seeds, 678
 Contract, sale by private, 461
 Contractors, timber work by, 170, 442
 Conversion of wood, 229, 482
 Coopers' wood, 594
 Cordwood, 285
 Cork, 668
 Cranberries, 829
 Crate-wood, 615
 Creosoting wood, 515
 Cryptomeria wood, 41
 Cup-shake, 189
 Curls, 182
 Curved timber, 151, 581
 Cylindrical shape of bole, 120
 Cypress wood, 40, 42
- D.
- Damage to wood by fungi, 145
 " " " " insects, 108
 Dammar, 781
 Dams for timber floating, 858
- Dead wood, 617
 Deals, 560
 Defects in wood, 148
 Depots for timber, 429
 Dimensions of trees, 117
 Discolouration of wood, 145
 Disposal of wood, 440
 Distillation of wood, 525
 Douglas fir wood, 87
 Drums, wood for, 608
 Dry fallen wood, 617
 Dry rot, 105
 Durability of timber, 97, 507, 564
 Dyes, 729
 Dynamite for splitting stumps and roots, 250
- E.
- Ebony, 85
 Elasticity of wood, 88
 Elmwood, 24, 593
 Even-grained wood, 88
- F.
- Faggots, 251
 Fascines, 515
 Felling rules, 228
 " trees, 205, 211
 Ferns, 387
 Field-crops in forests, 749
 Fineness of grain, 88
 Firewood, 288, 261, 285, 617
 Fissibility of wood, 86
 Flexibility of wood, 95
 Floating wood, 858
 Flutes, wood for, 610
 Forest devil, 201, 218
 " litter, 758
 " roads, 801
 " tramways, 884
 Forked trees, 152
 Frost-crack, 140
 Fruit, edible forest, 829
 " of forest trees, 666
 Fungi, destructive, 105, 188

G.

Galls, oak, 635
 Glaziers' wood, 607
 Grass-cutting in forests, 746
 Grass-seeds, 824
 Gravel, 831
 Grazing, forest, 737
 Grubbing up stumps, 217
 Guaiacum wood, 84, 87
 Gums, 730
 Gunpowder for blasting stumps
 and roots, 248
 Gunstocks, wood for, 610
 Gutta-percha, 738

H.

Handles of tools, 588
 Hardness of wood, 48, 111
 Haskenising wood, 509
 Hawkeye machine, 232
 Hazelwood, 199
 Heartshake, 138
 Heartwood, 44
 Heather, 772
 Heating-power of wood, 107
 Hemlock spruce, 41
 Herbage in forests, 787
 Hickory wood, 593
 Hook-lever, 267
 Hoops for barrels, 600
 Hop-poles, 614
 Hornbeam wood, 29
 Horse-chestnut wood, 31
 Humus, 759
 Hurdle wood, 615
 Hygroscopicity of wood, 67

I.

Implements, felling, 174
 Injection of wood, 116, 512
 Insects, destructive to wood, 103
 Instruments, action of, on wood,
 111
 Internal bark, 137

J.

Jacaranda wood, 35
 Jarrah wood, 579
 Jhuming, 749
 Joiners' wood, 585
 Juniper wood, 42

K.

Knee-pieces, 582
 Knopperrn-galls, 635
 Knottiness, 133
 Krempe, 268
 Kyanising wood, 519

L.

Lac, 731
 Ladders, wood for, 593
 Lamp-black, 550
 Land-transport, 300
 Larch bark, 661
 Larchwood, 87
 Laths, 560
 Lead-pencils, 606
 Leaf-fodder, 694
 Length of stem, 117
 Lignin, 79
 Lime-bast, 663
 Litter, forest, 758
 Logs, 236, 257, 556
 Lopping branches, 694
 Lucifer matches, 605
 " " boxes for, 602

M.

Machines for converting wood, 499
 " for uprooting stumps, 199
 Machine saws, 483
 Mahogany, 32
 Manual labour, 156
 Maple wood, sugar, 27
 Markets for timber, 447
 Mast, oak and beech, 693
 Masts for ships, 579

Matches, lucifer, 608
 Measures, wood for, 608
 Merulius lacrimans, 105
 Mining timber, 578
 Minor forest produce, 629
 Mistleto, damage by, 188
 Model-making, 588
 Mosses, 769, 828
 Moss-litter, 769
 Myrobalans, 685

N.

Non-inflammable wood, 524
 Numbering hammers, 291

O.

Oak-bark, 636
 Oakwood, 20
 Oars, wood for, 601
 Oil of turpentine, 699, 728
 Oils, 784
 Olive wood, 84
 Optimum climate, 56
 Oxalic acid, 555

P.

Packing-cases, wood for, 589
 Padauk, 86
 Palmwood, 16
 Paper-pulp, 160, 501, 551
 Park-palings, 615
 Parquetry, 585
 Pasture, 787
 Pavements, wood for street, 568
 Pea-sticks, 614
 Peat, digging, 790
 „ litter, 821
 Pianofortes, wood for, 590
 Pigs in forests, 698
 Pitch pine, 106, 625
 Pit-props, 574
 Planing machines, 500
 Planks, 498
 Pliability of wood, 95, 507

Poles, 287, 260
 Pony saws, 494
 Poplar wood, 81
 Potash, 550
 Private contract, sale by, 461, 467

Q.

Quarrying stone, etc., 881
 Quebracho wood, 624, 684
 Quinine, 784

R.

Rafting timber, 407
 Railway-carriages, wood used for,
 594
 „ sleepers, 570
 Red deal, 579
 Redwood, 41
 Resin-galls, 125
 „ in wood, 704
 „ tappin, 706
 Resinosis, 155
 Resistance to strains, 88, 563
 Rhytidome, 681
 Roads, 801
 Robinia wood, 26, 595
 Rolling wood from felling-area, 276
 Rose wood, 85
 Rosin, 704
 Royalty on wood, 451, 462

S.

Sabots, 609
 Sale-lots, 291
 Sales of wood, 447
 Salicin, 784
 Sand, pits for, 881
 Sapwood, 44
 Saws, 181
 „ resistance of wood to, 118
 Saw-dust, 616
 „ mills, 488
 „ sets, 192
 Sawn timber, 559
 Scantlings, 110

Scent of wood, 47
 Scots pine wood, 37
 Sealed tenders for wood, 461
 Season for felling, 204
 Seasoning wood, 506
 Seeds of conifers, 667, 673
 " " other forest trees, 666
 Seed-kilns, 628
 Sequoia wood, 41
 Shingles for roofs, 601
 Ship-building, 577
 Shoemakers' pegs, 606
 Shrinkage of wood, 72
 Silver fir-wood, 40
 " grain, 559
 Slack barrels, 599
 Sledge-roads, 306
 Sledges, 270
 Slides, timber, 316
 Sliding logs, 275
 Sorting wood, 254, 284
 Sounding boards, 590
 Spars, 584
 Specific weight, 50
 Spokes for wheels, 592
 Spruce wood, 37
 Stacking wood, 254, 285, 437
 Stakes, 614
 Staves for casks, 594
 Steaming wood, 96
 Stone quarries, 881
 Storing seed, 687
 Straightness of stem, 121
 Street pavement, 568
 Strength of timber, 88, 568
 Stumps, 217
 Sugar in trees, 82, 728
 Sumach, 624
 Summer wood, 15
 Superstructures, 561
 Swelling of wood, 72

T.

Tanning bark, 638
 " extracts, 635

Tar, 546
 Taxodium wood, 41
 Teak wood, 578
 Telegraph-posts, 260
 Teredo, 105
 Termites, 104
 Thuya wood, 42
 Timber-assortments, 257
 " chutes, 278
 " slides, 316
 " trade, 447
 Tools, wood for handles of, 588
 Toys, children's, 610
 Tramways, forest, 384
 " wire, 346
 Transport, 300
 Transverse strength of wood, 93
 Tree-props, 615
 Trenails, 606
 Truffles, 828
 Tulip wood, 86, 587
 Turnery, 611
 Turpentine, oil of, 699, 723
 Twisted fibre, 128

U.

Uprooting trees, 219
 Uses of woods, 620

V.

Valonea, 624
 Vanillin, 728
 Veneer, 499, 587
 Venetian blinds, 590, 605
 Vine-stakes, 615
 Violet wood, 86
 Violins, 607
 Vulcanising wood, 509

W.

Wages, 164
 Warping of timber, 72
 Water-pipes, 567
 " transport, 353

- Wavy wood, 129
 Wedges, 194
 Weight of wood, 50
 Weirs, 872
 Weymouth pine wood, 39
 Wheels, 591
 Wheelwrights' work, 591
 White ants, 108
 Willow wood, 31
 Winter felling, 209
 Wire-tramways, 346
 Withes, 613, 616
 Wohmann's machine, 202
 Wood-assortments, 254
 Wood-carbonisation, 527
 " carving, 608, 610
 " depots, 429
 " engraving, 611
 " gas, 526
 " paving, 508
 " plaiting, 618
 " pulp, 501
 " tapestry, 602
 " transport, 300
 " " by water, 353
 " wool, 500, 604
 Woodcutters' implements, 174
 Wooden shoes, 609

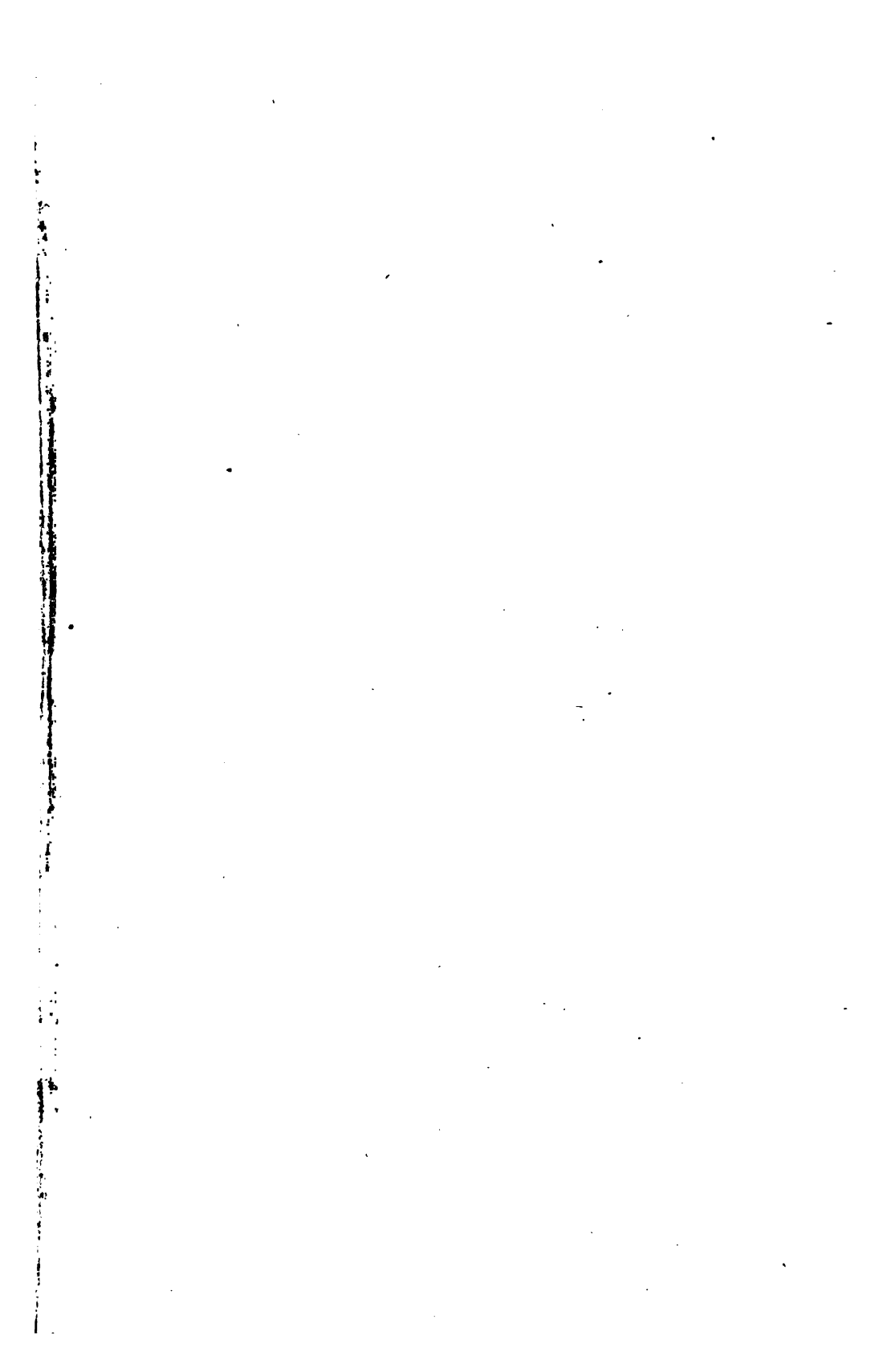



3 2044 102 817 319

